

$$3 - 2 = \square$$

$$3 - 0 = \square$$

$$3 - 1 = \square$$

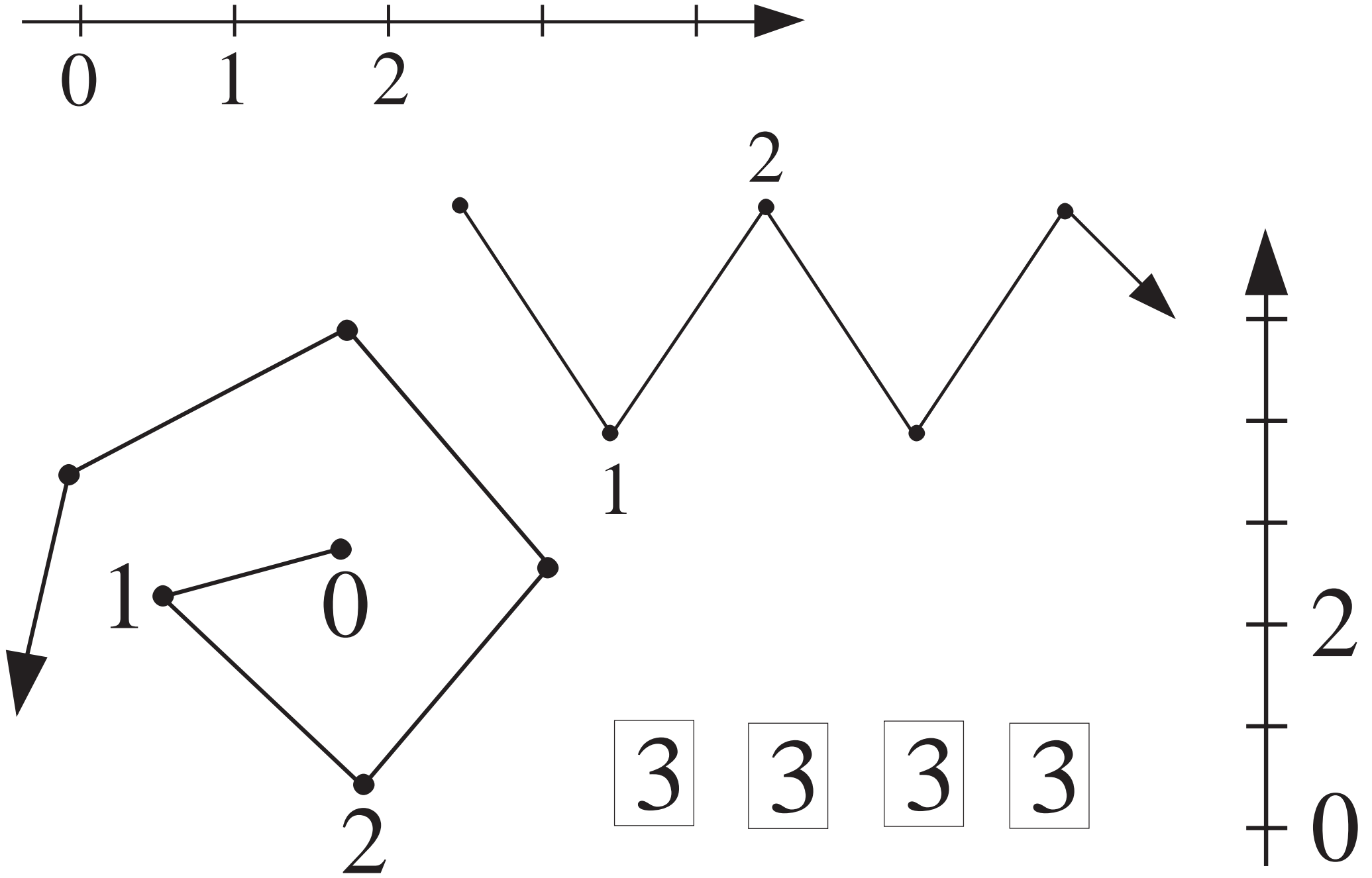

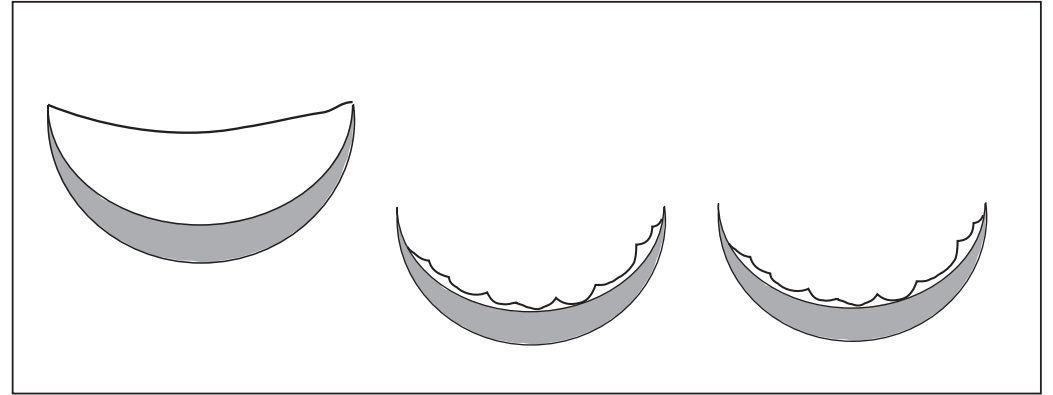
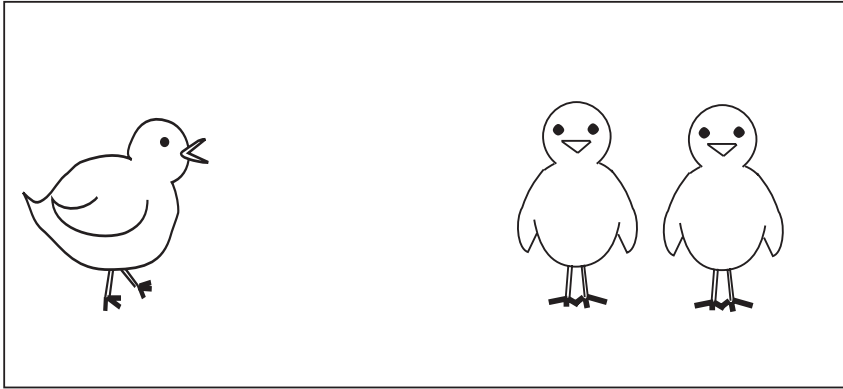

3	=		+	2
---	---	--	---	---

3	-		=	1
---	---	--	---	---

LP 34/1

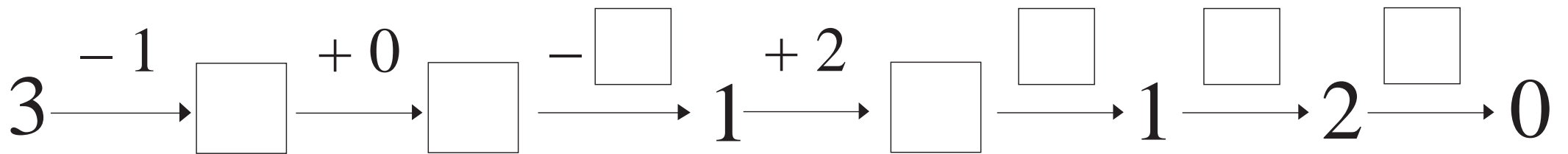

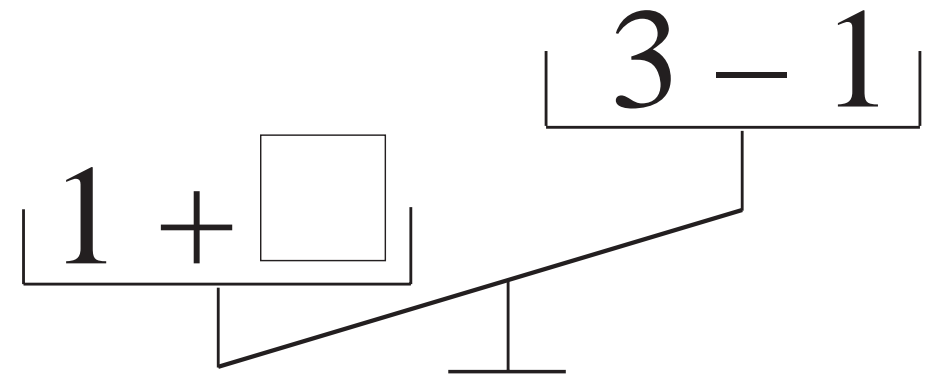
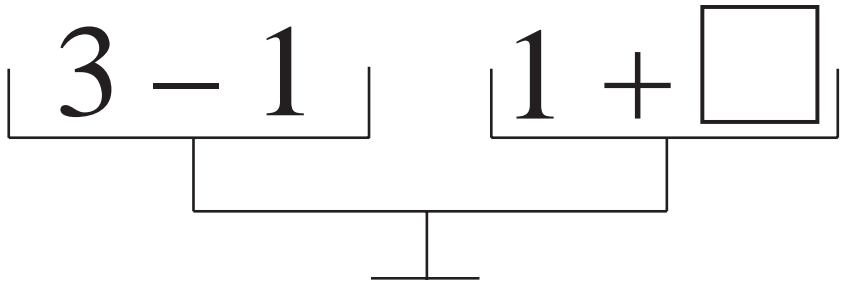

□ =

□ :

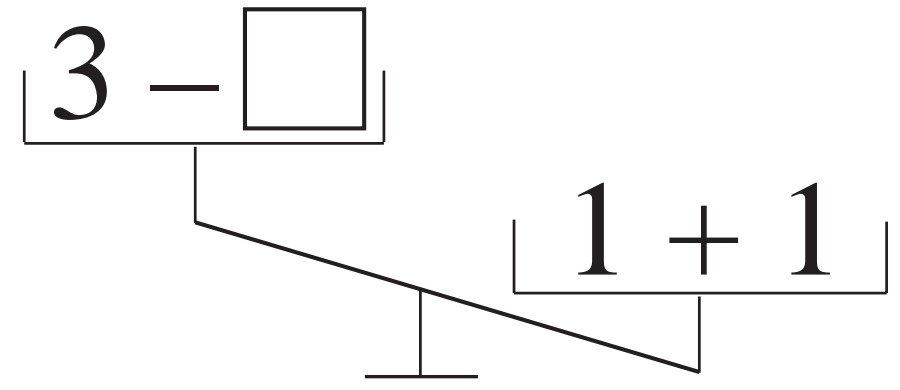

□ :

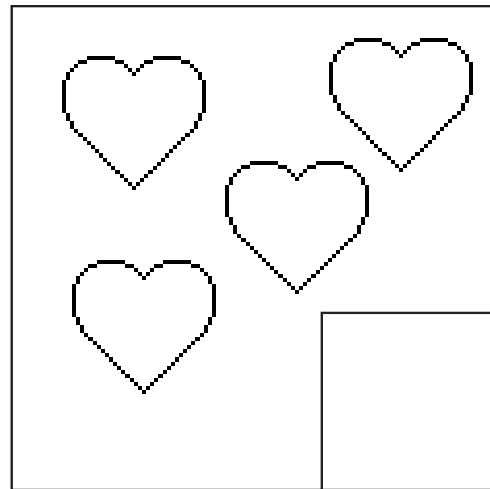
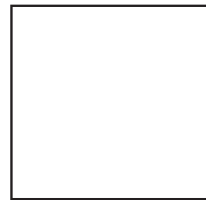
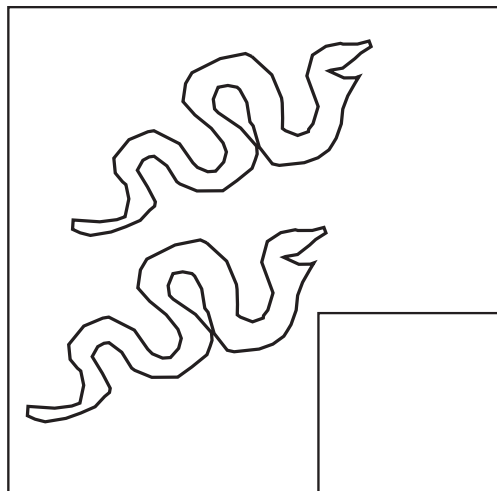
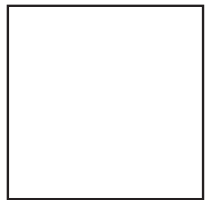
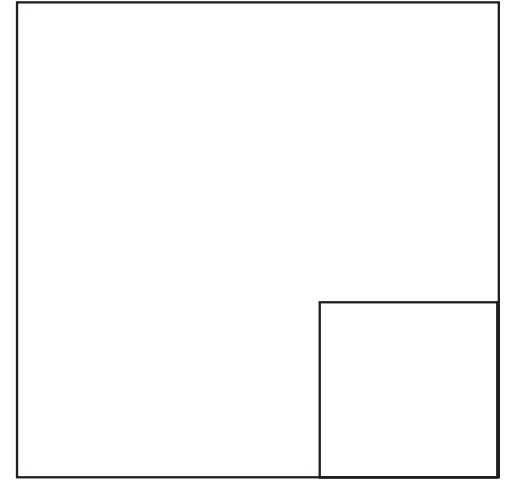
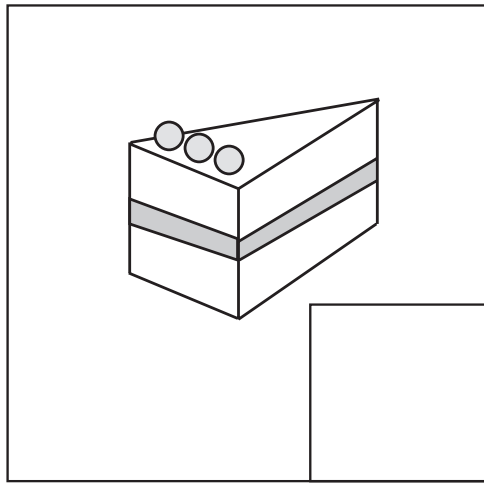
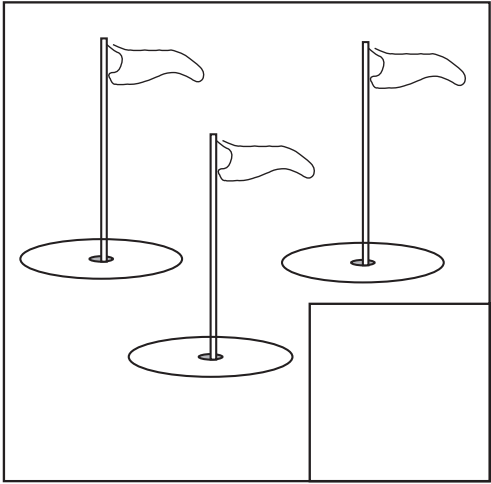
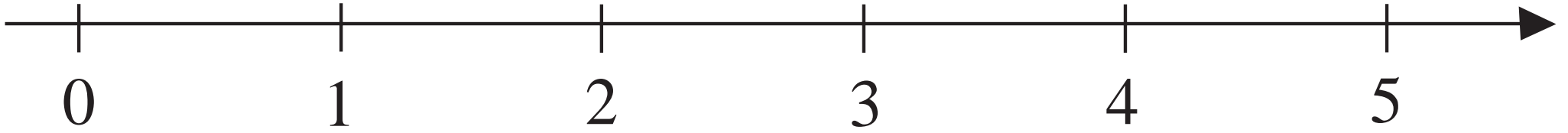

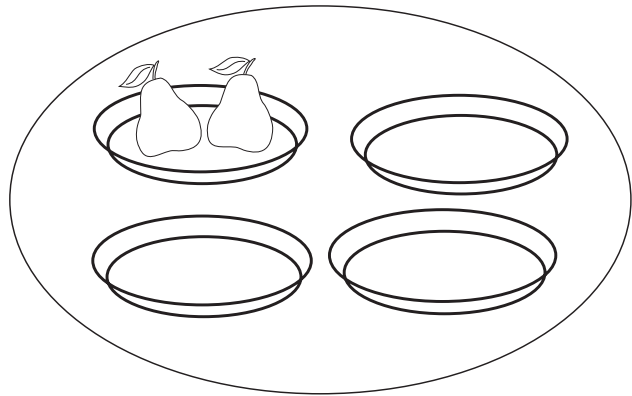

4	-	3	=	
---	---	---	---	--

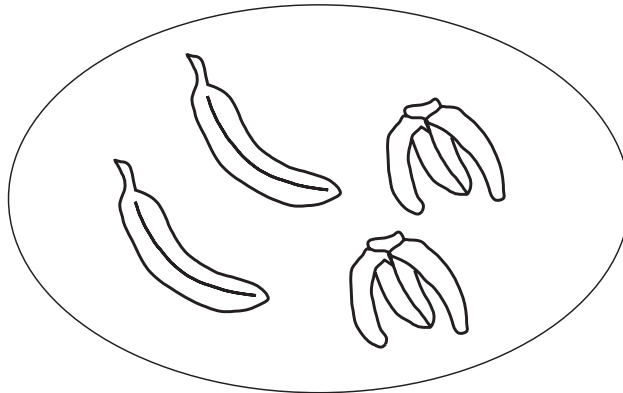

	-		=	
--	---	--	---	--

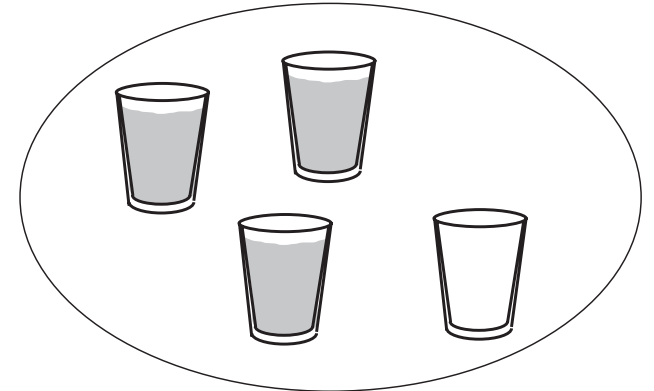

			=	
--	--	--	---	--

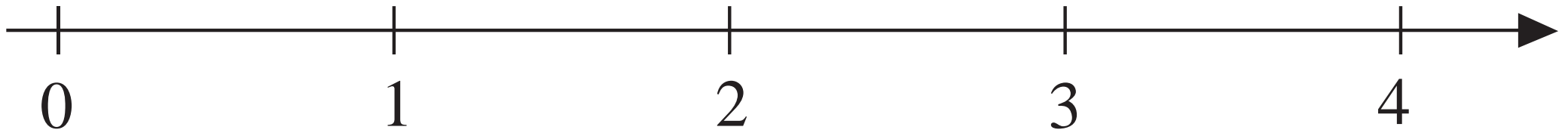

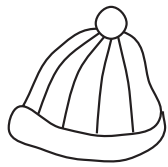
				
4	=	1	+	

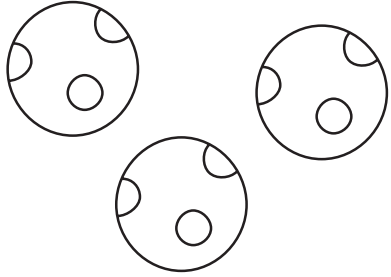
				
4	=		+	3

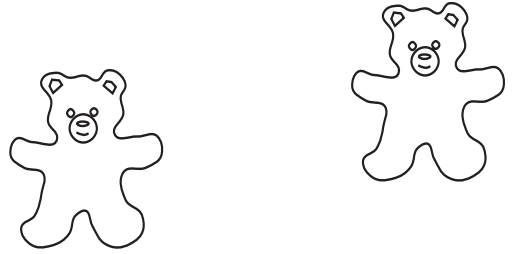
				
4	=		+	2

LP38/6

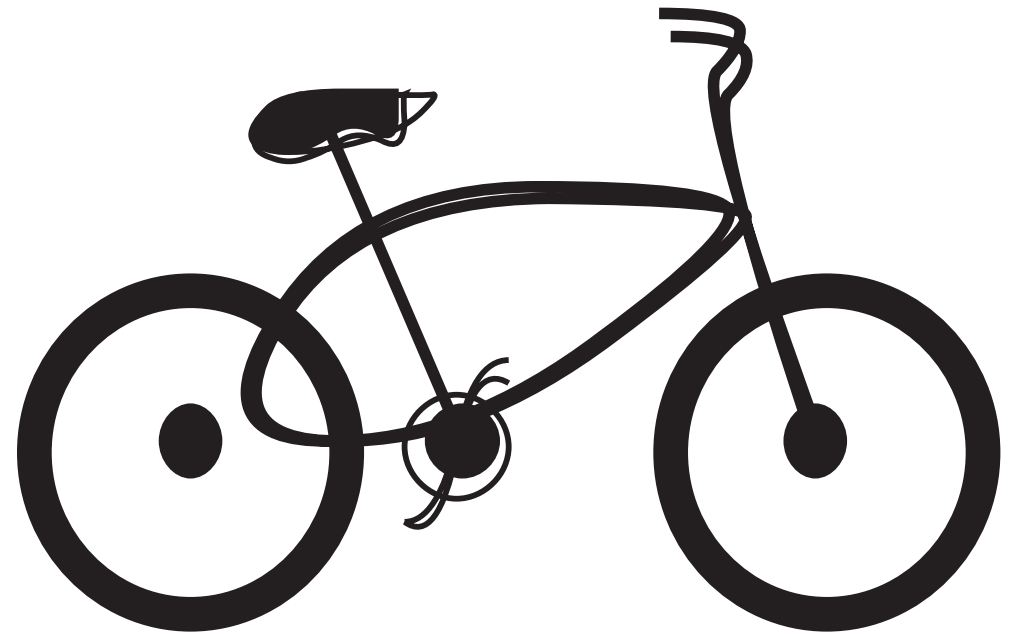
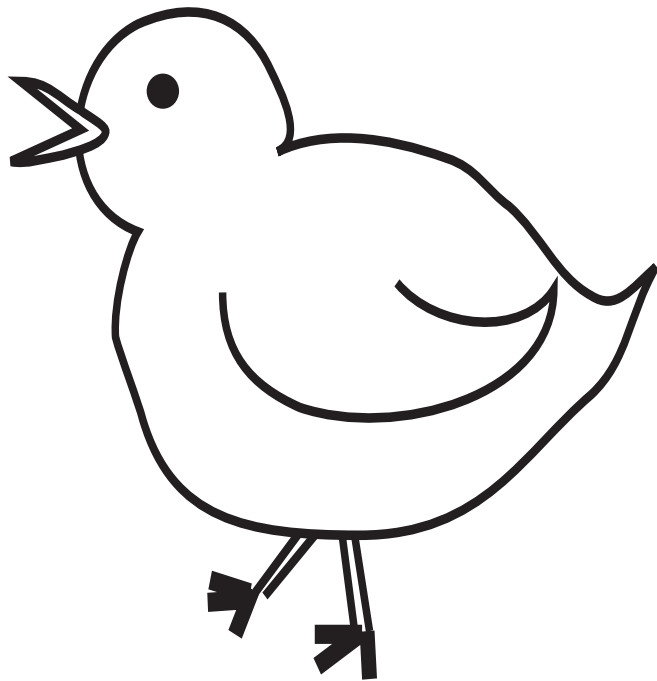

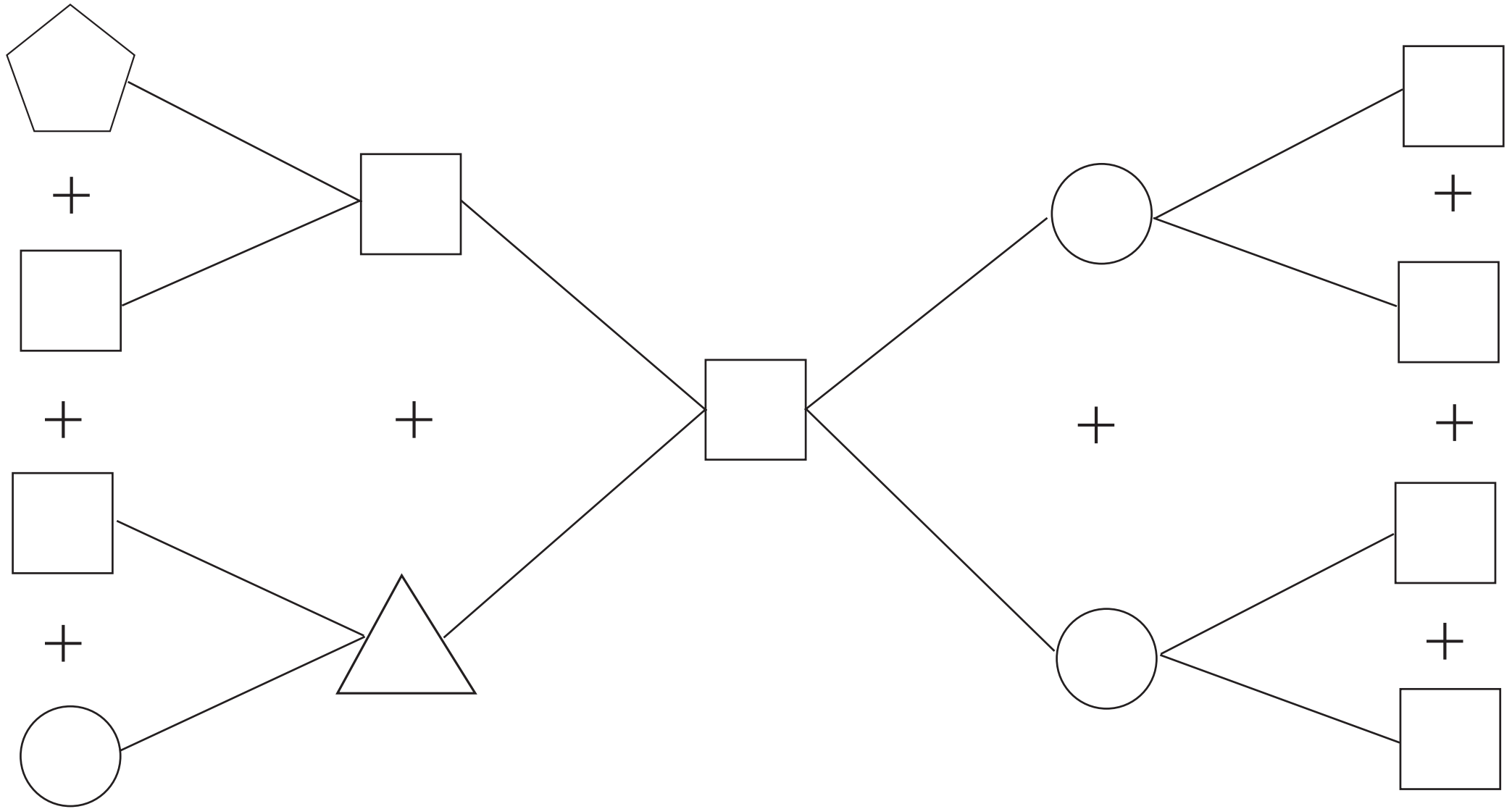

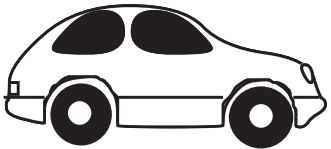
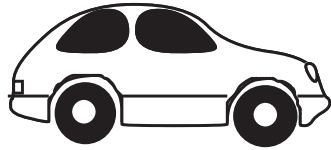
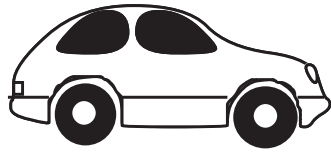
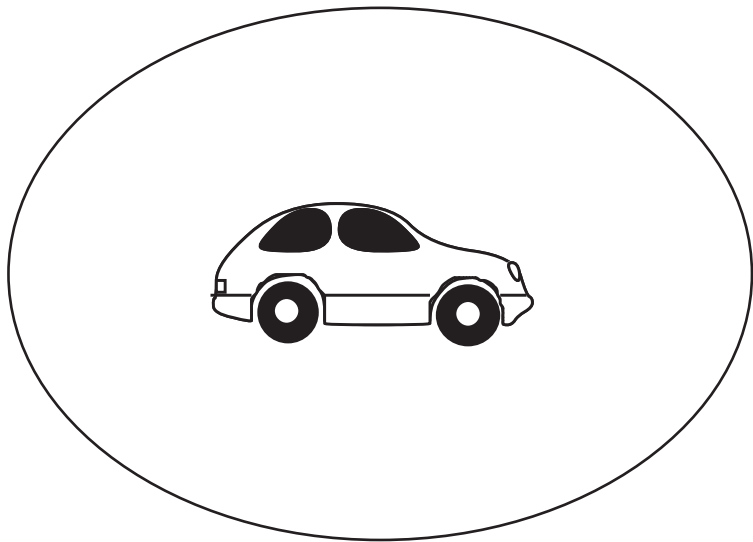

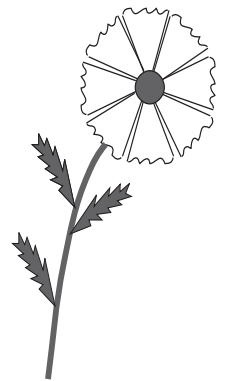
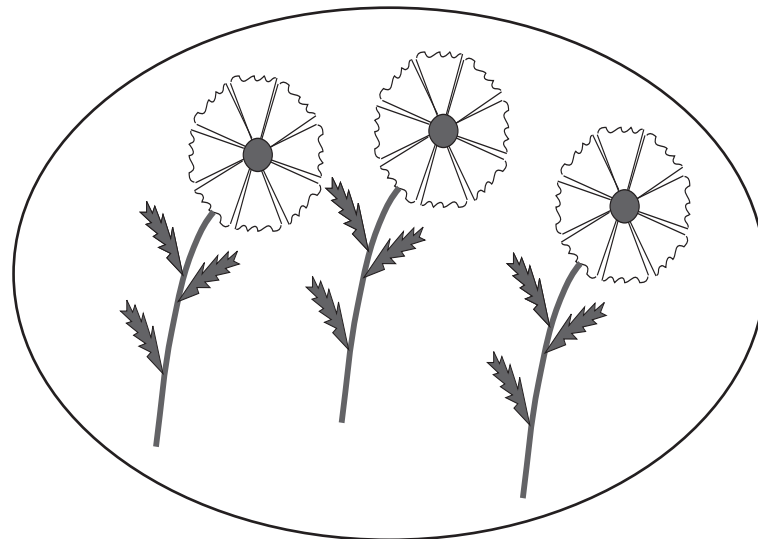
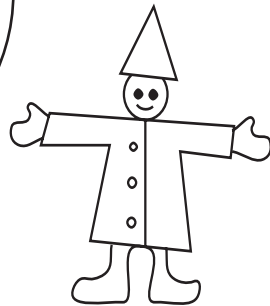
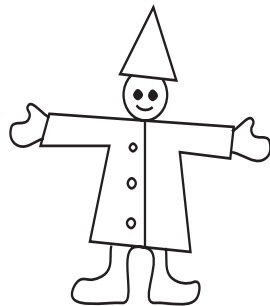
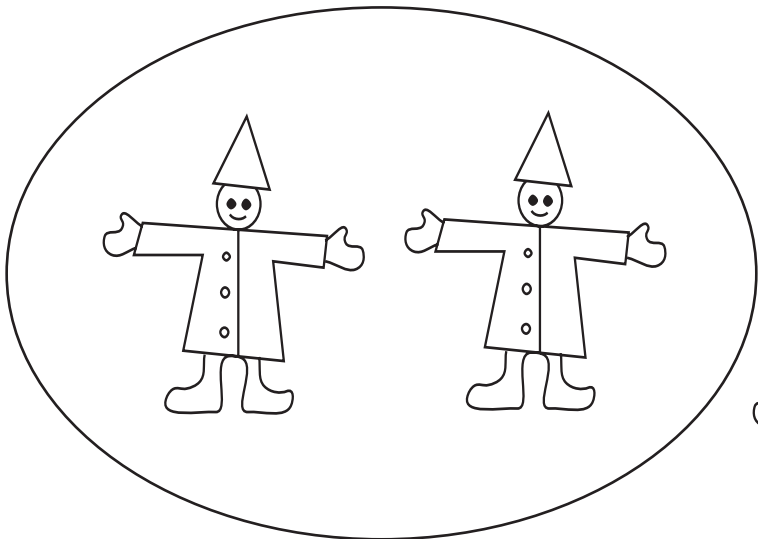



A								
B								
A+B								

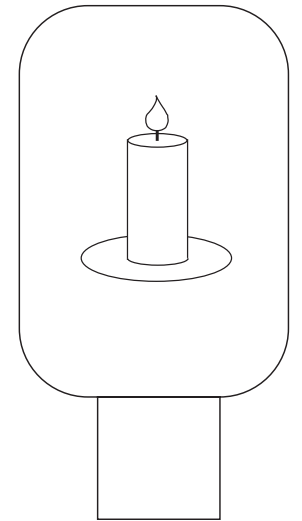
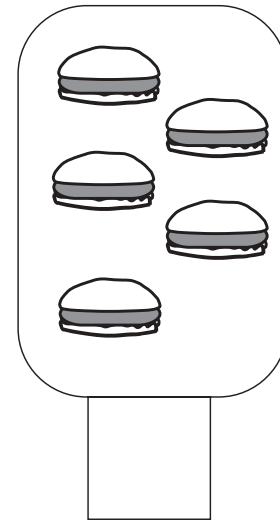
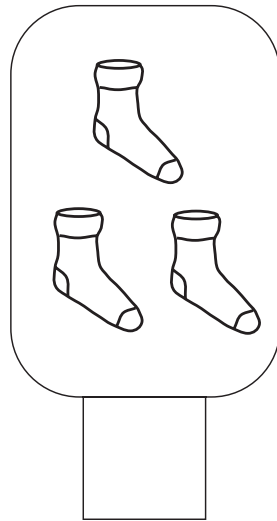
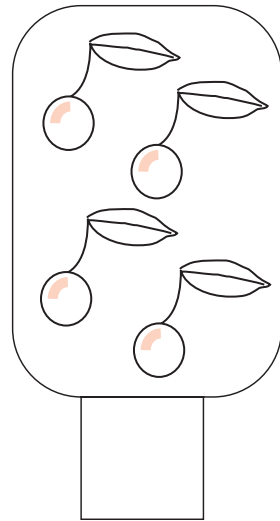
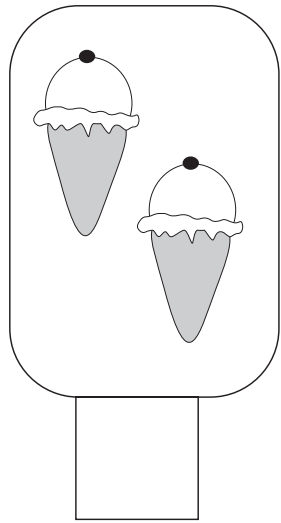
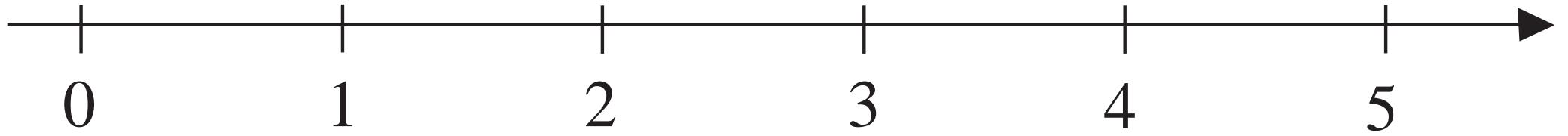

5	-	3	=	

	-		=	

			=	



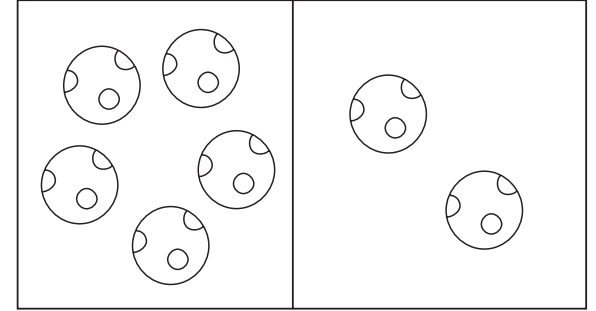
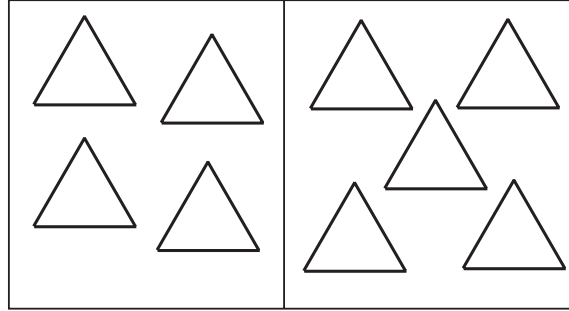
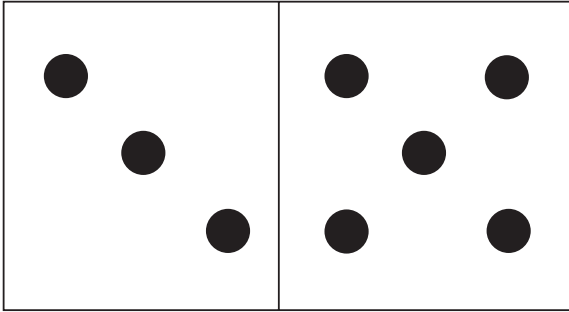

3	\triangleleft_2	5		
5	\triangleright_2	3		
3	+		=	5
5	-		=	

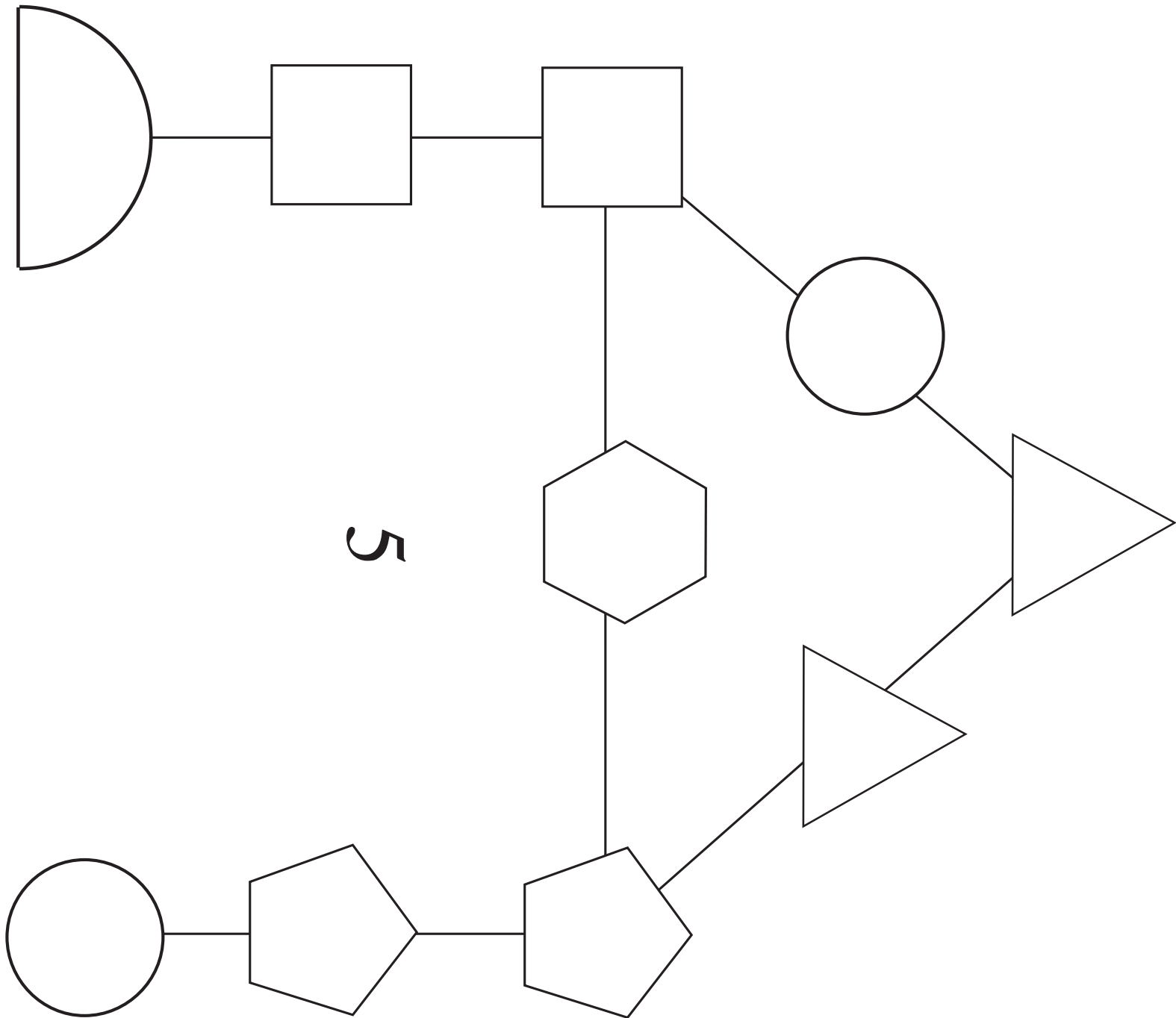

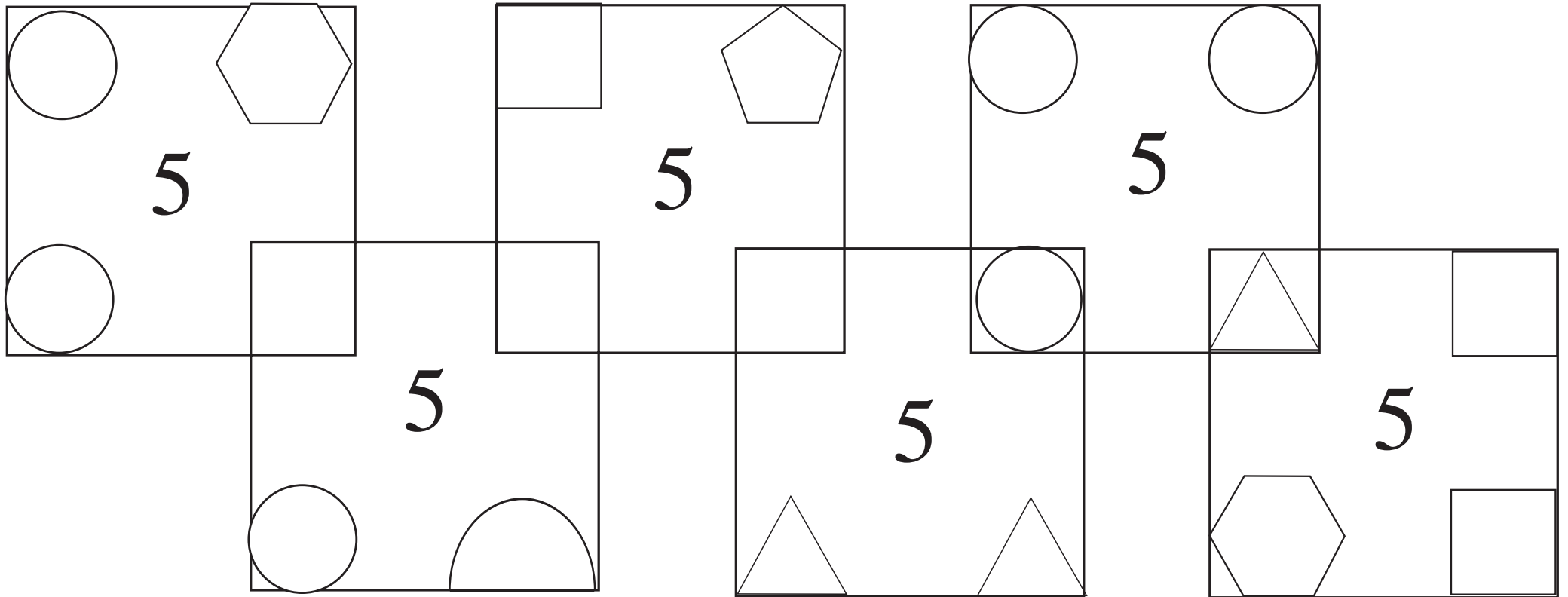

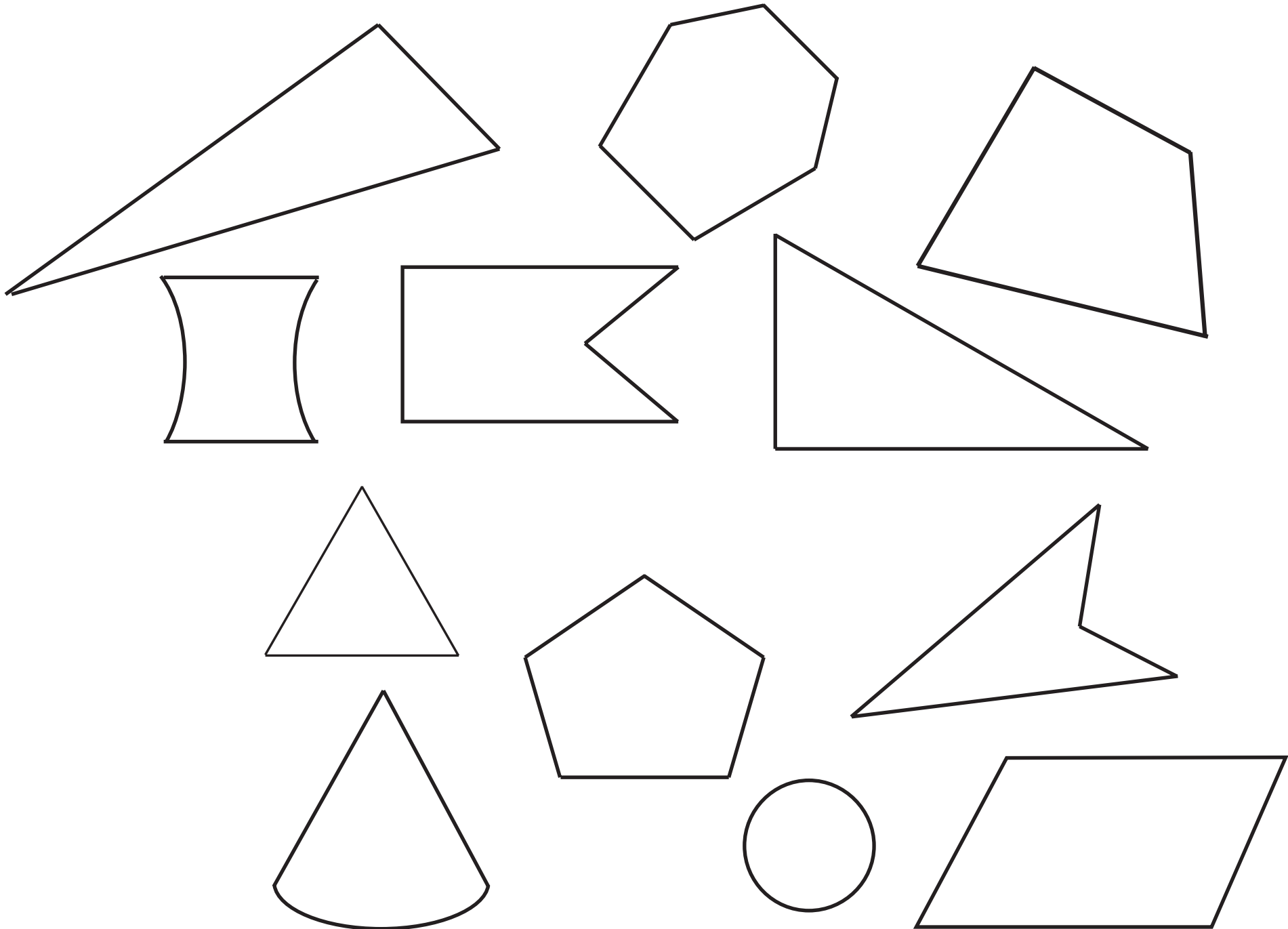

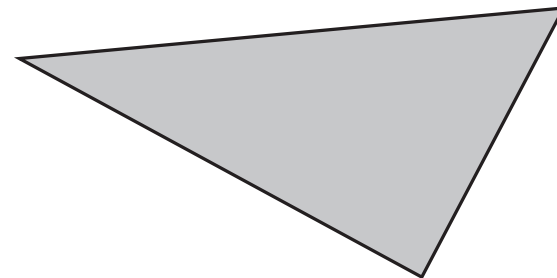
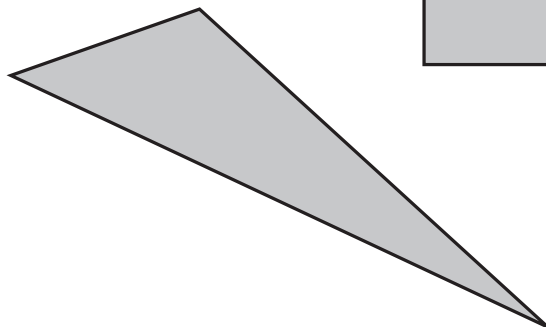
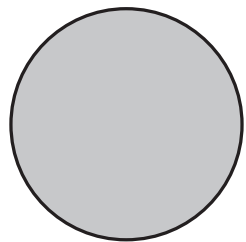
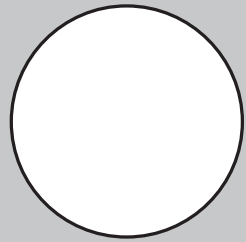
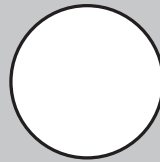
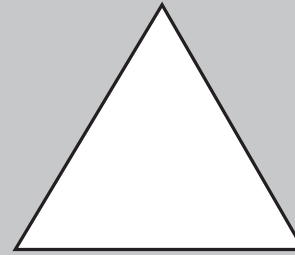
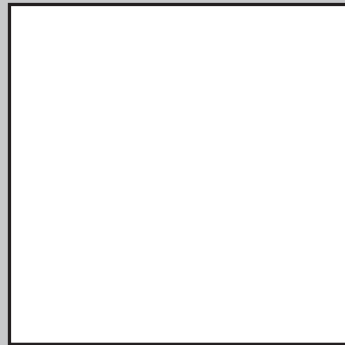
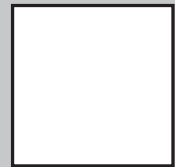
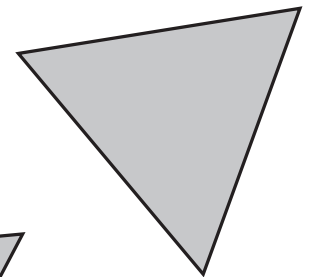
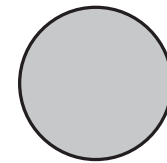
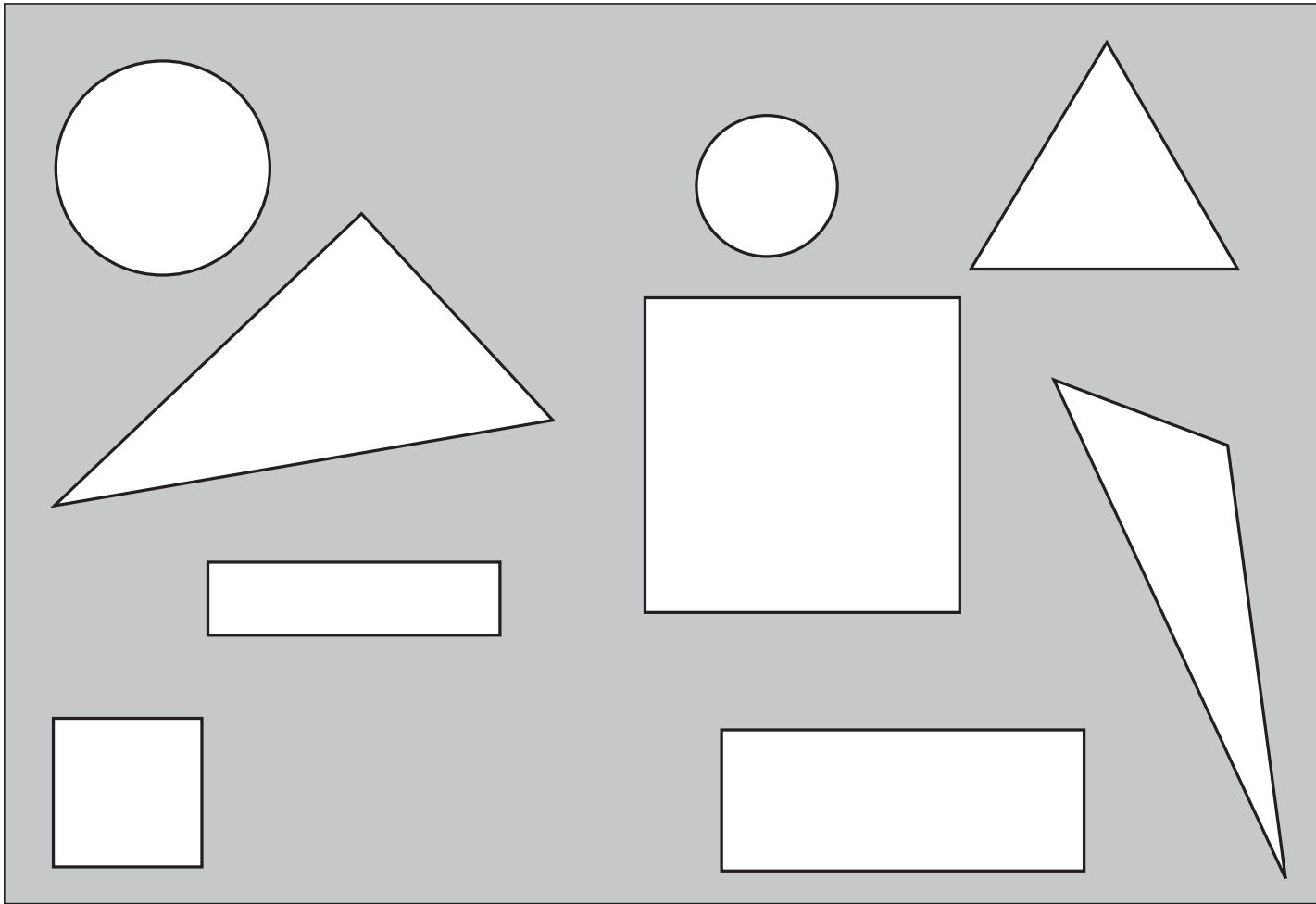

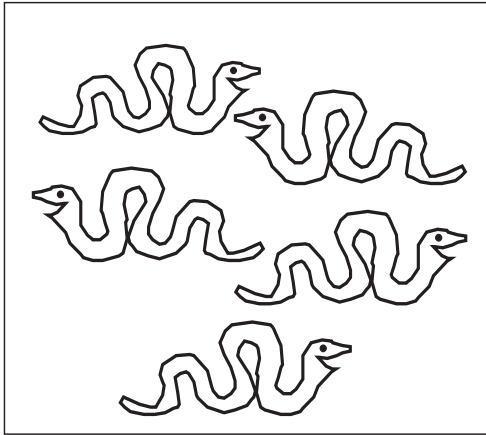

1 < 2

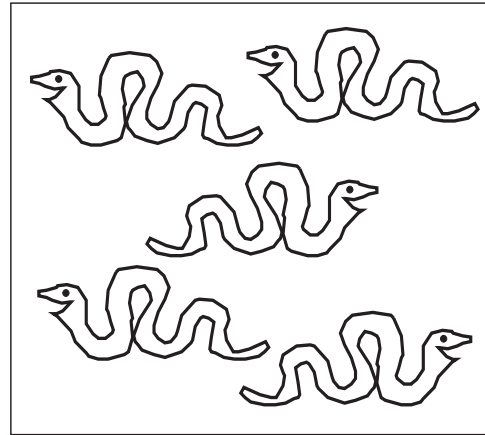

5 > 2

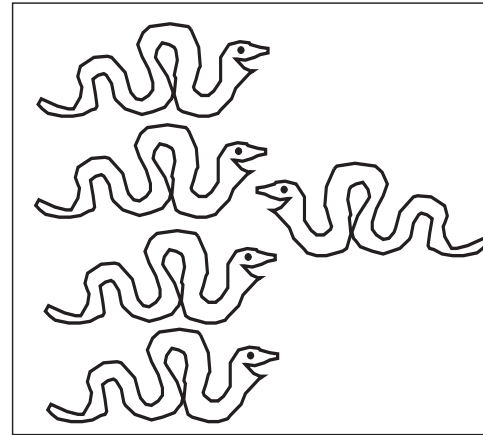

> 2

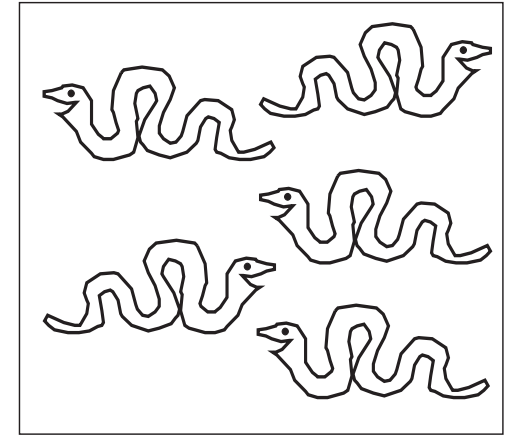

< 3 4

$$4 = \boxed{\times}$$



$$\boxed{\times} < 4$$

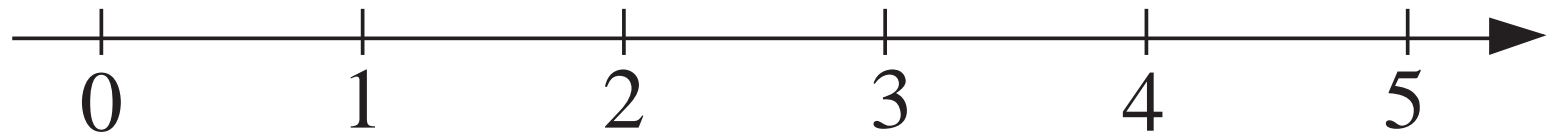

$$3 < \boxed{\times}$$

