

Spent (p)					
Had left (p)					

LP 89/2

a)

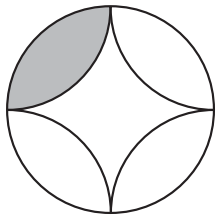

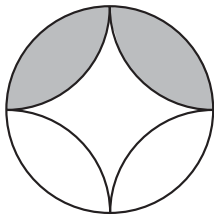

b)



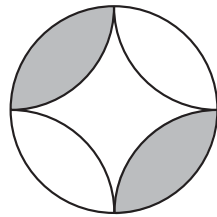

c)

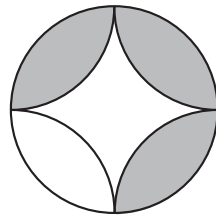



d)

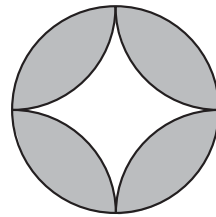



e)

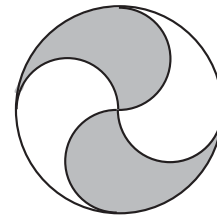



f)

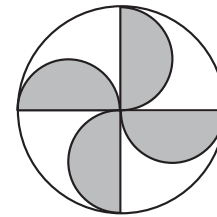



g)

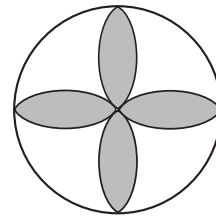

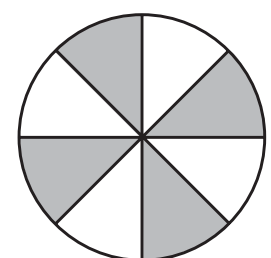
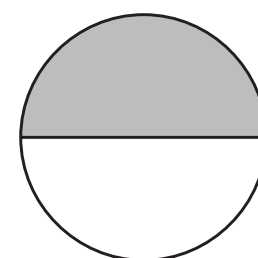
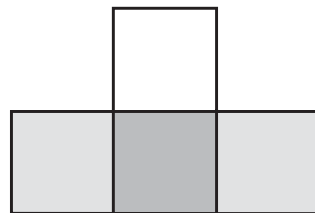
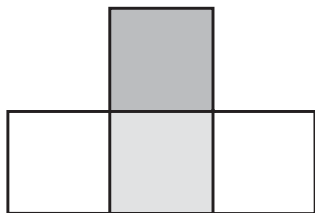
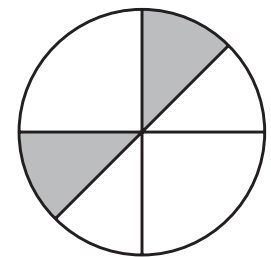
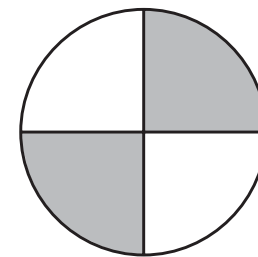
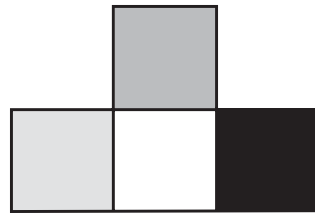
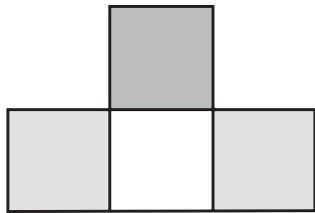
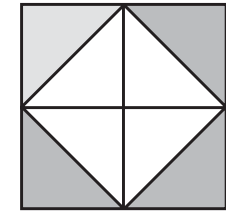
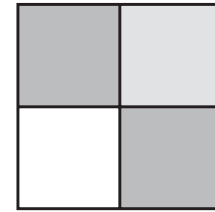
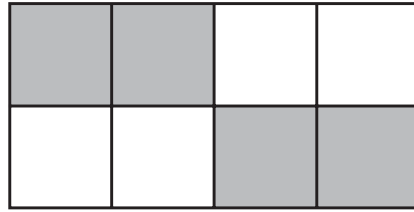
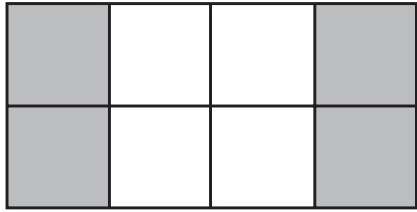
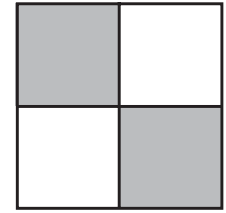
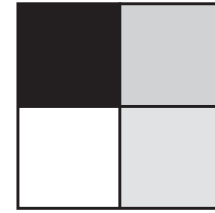
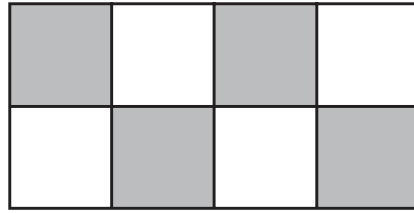
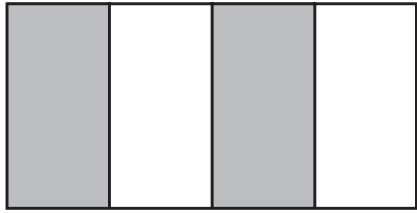

h)

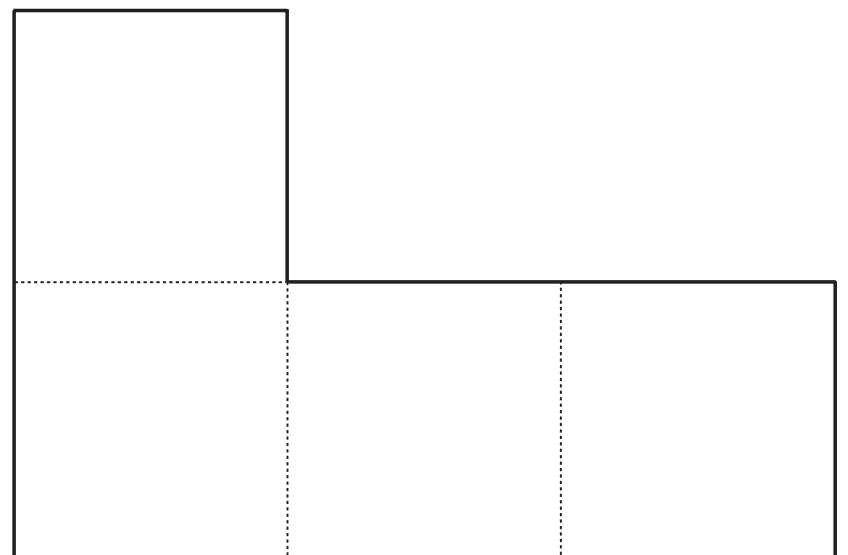
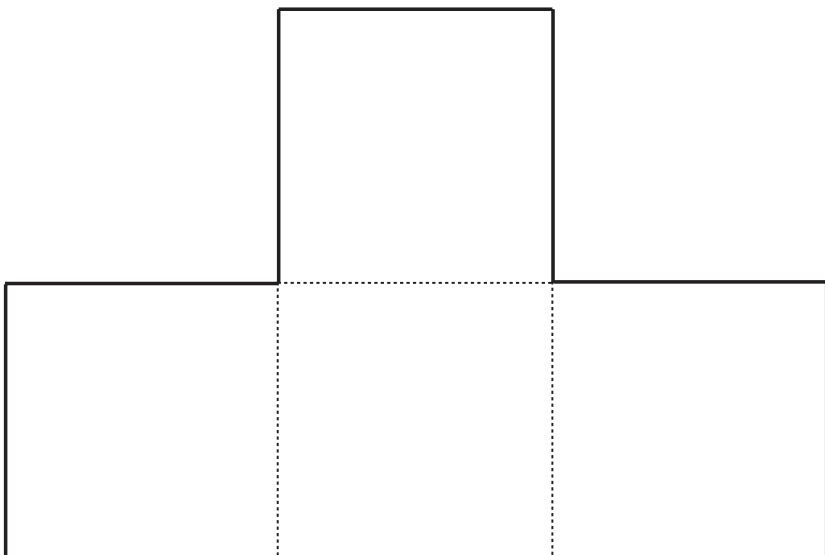
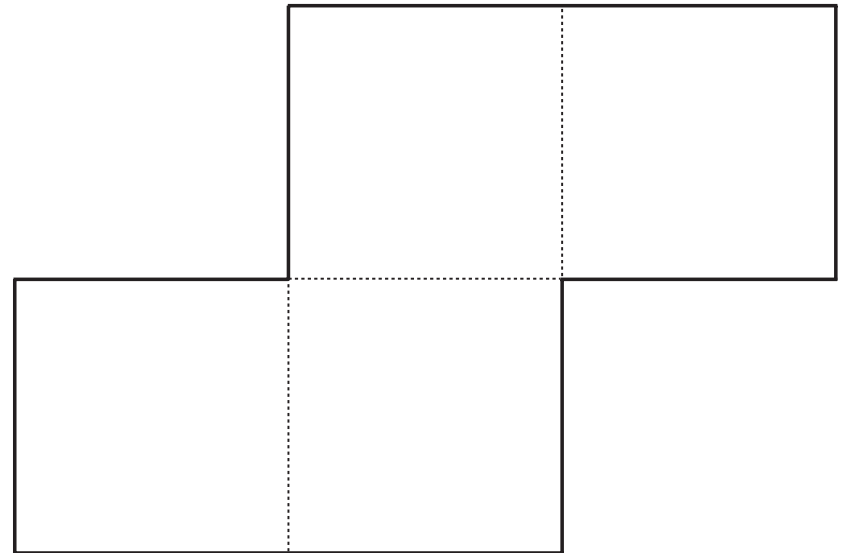
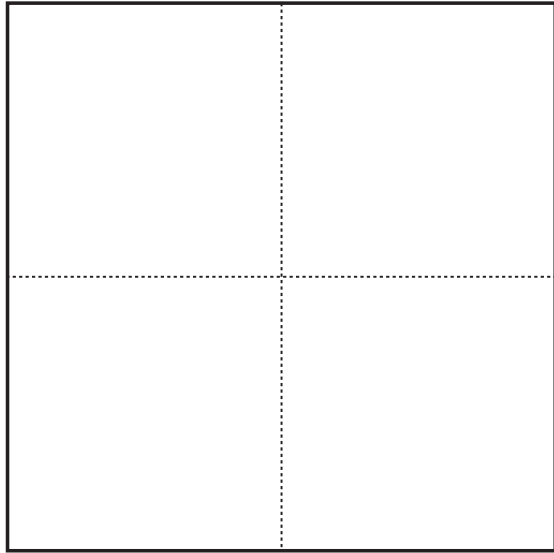



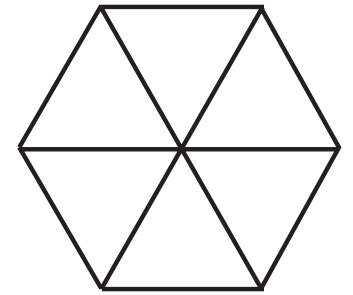
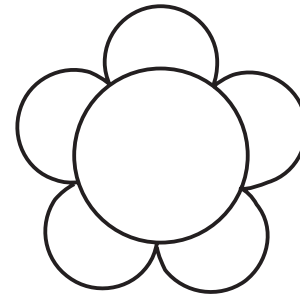
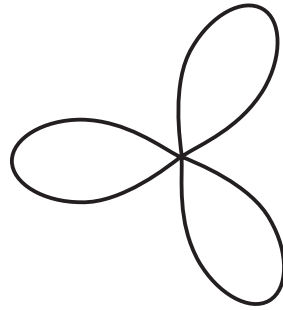
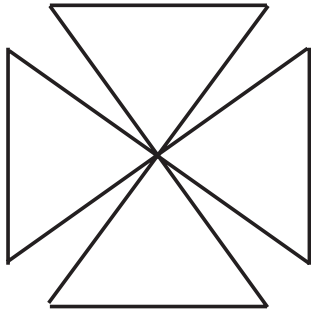

a)



b)

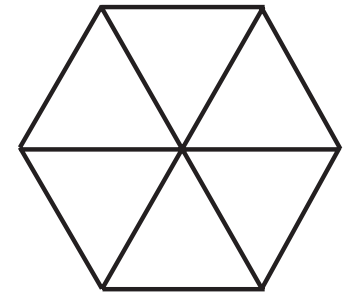
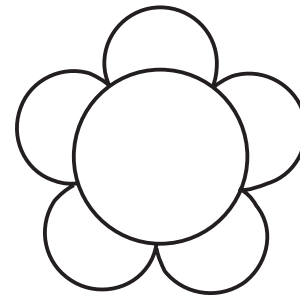
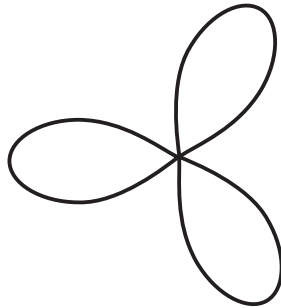
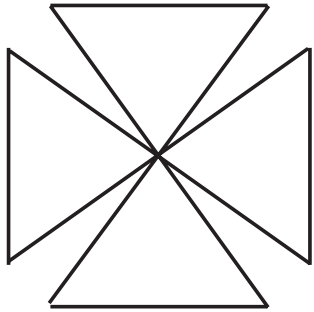

c)

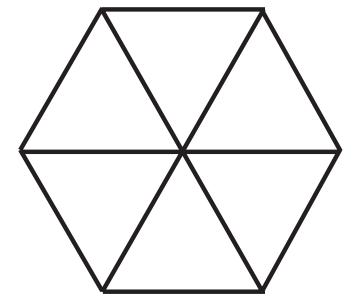
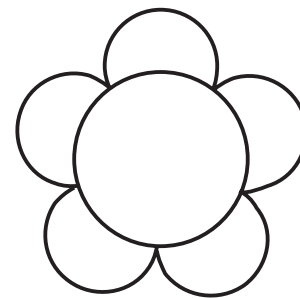
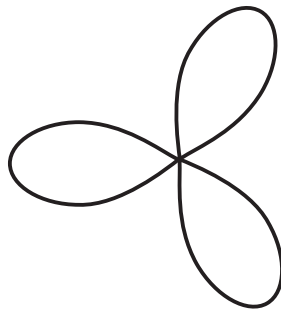
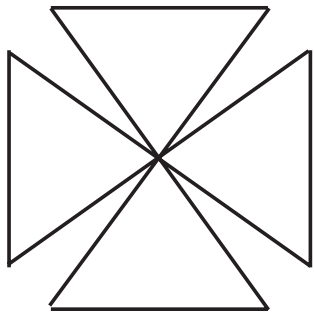

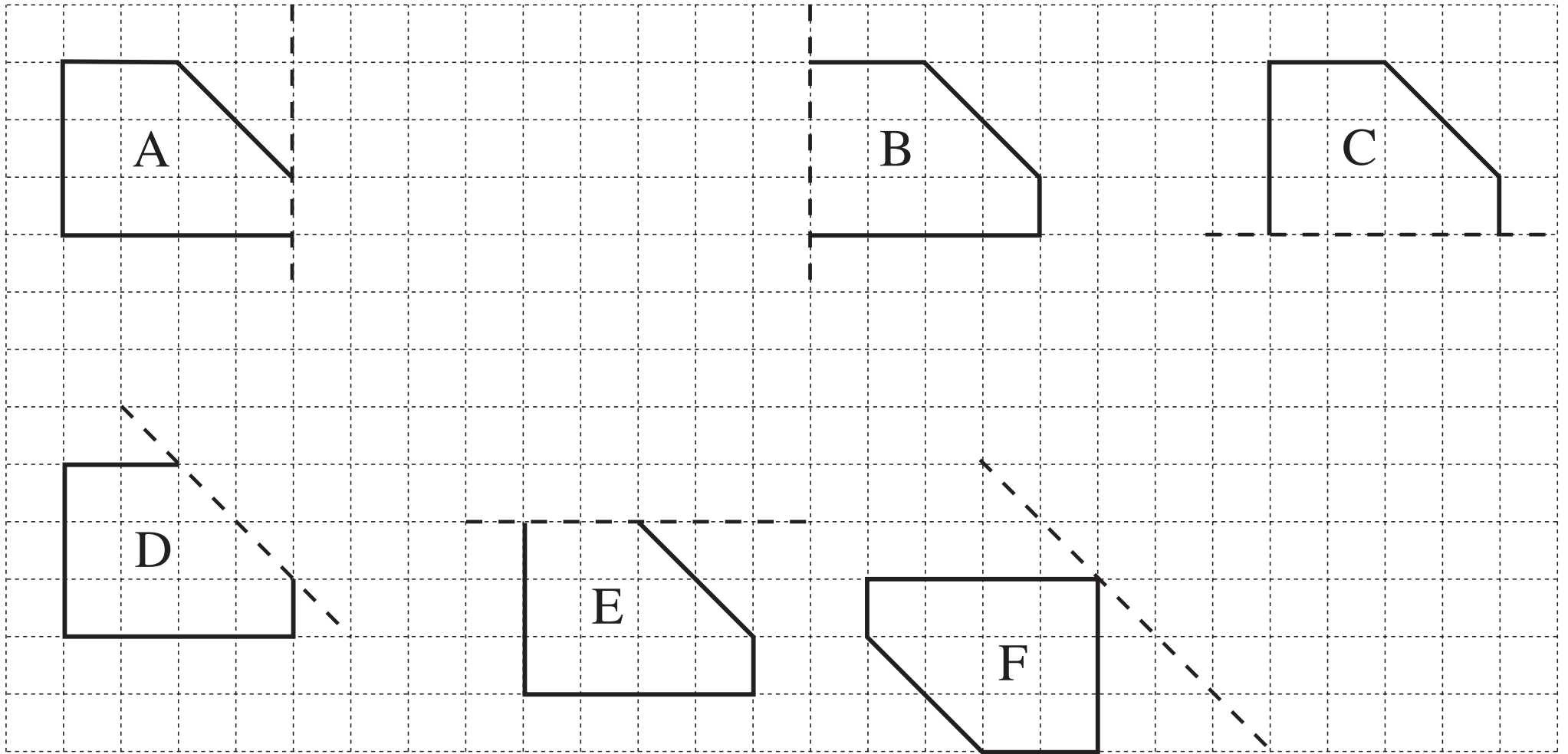

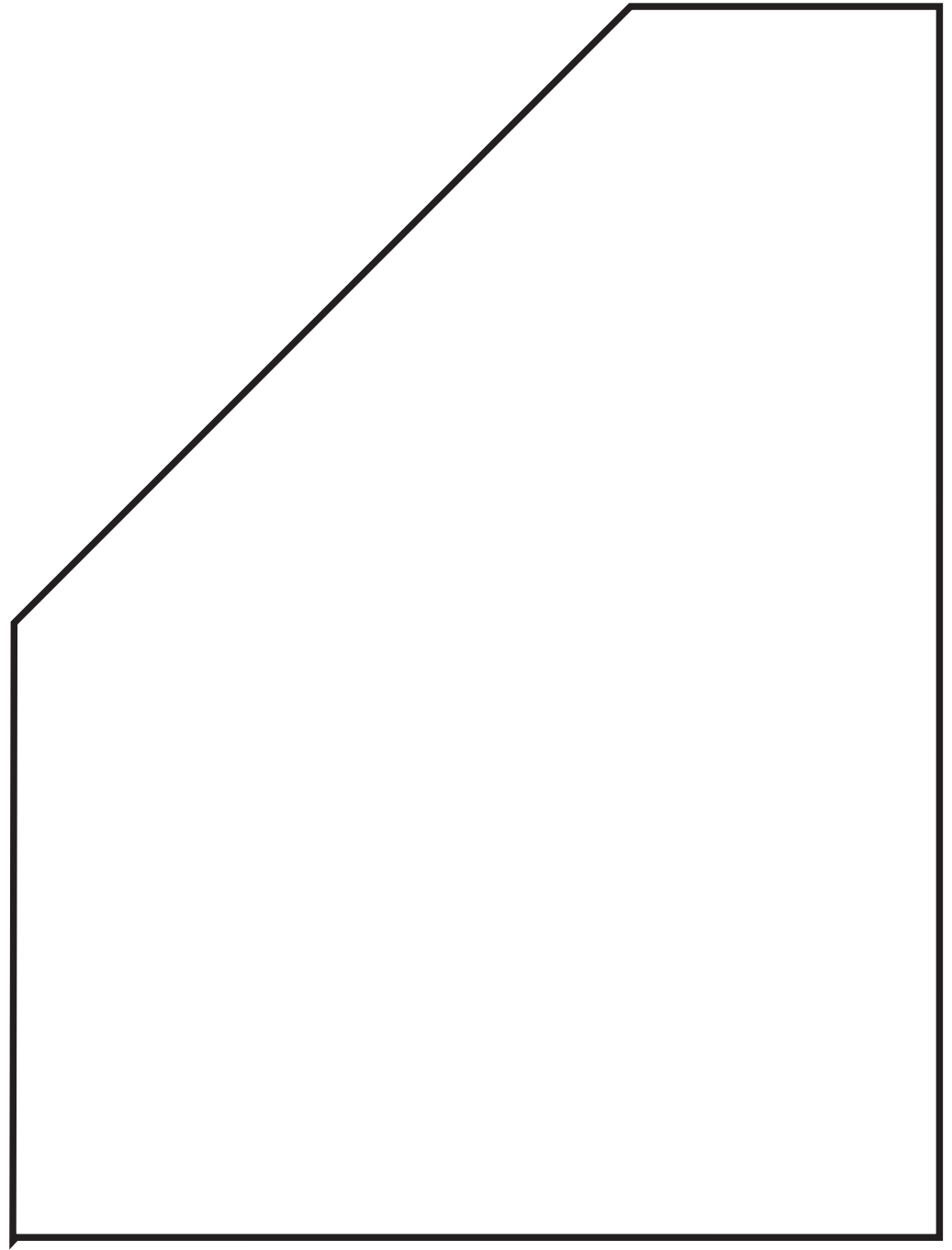
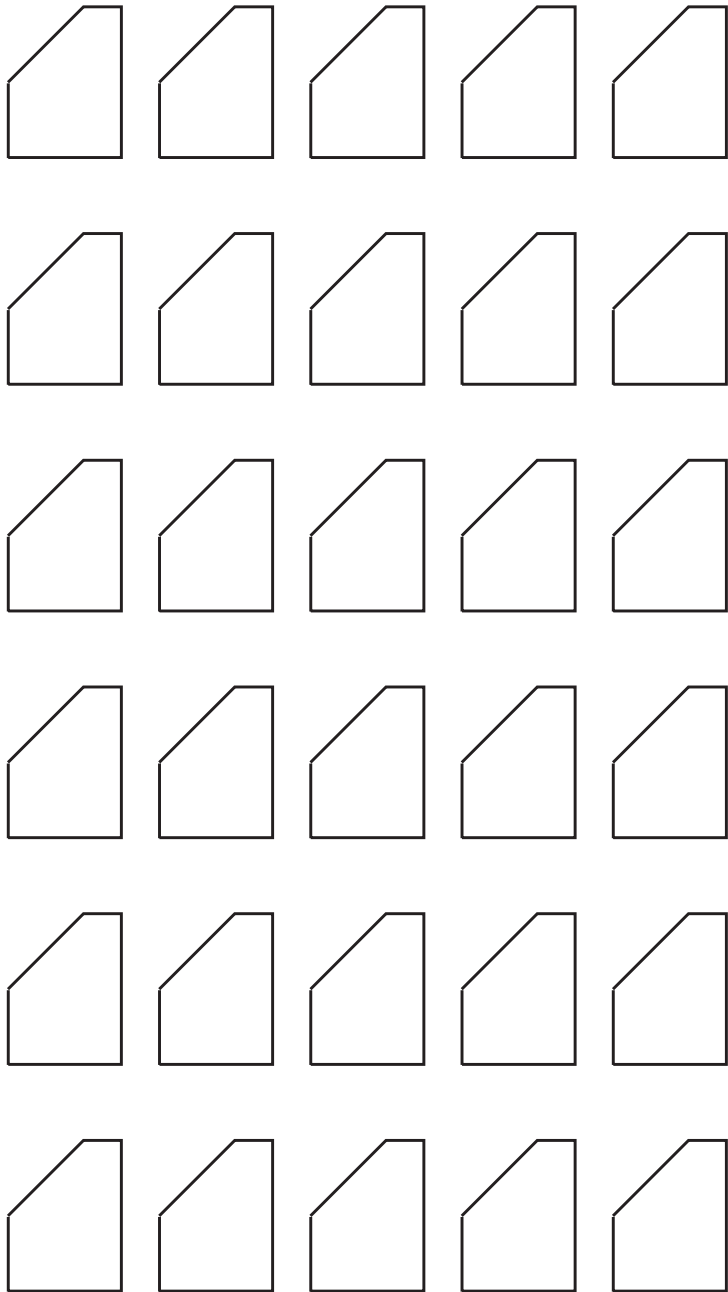

a)

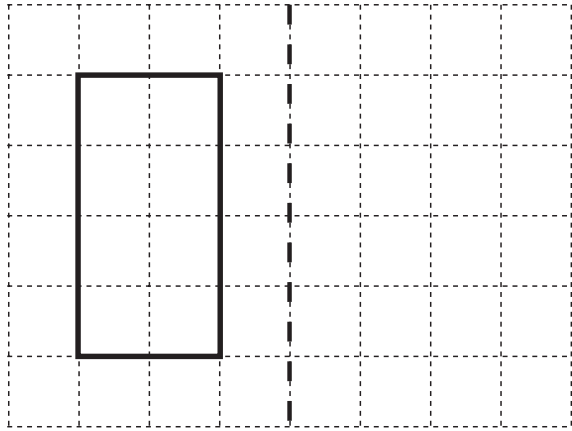

b)

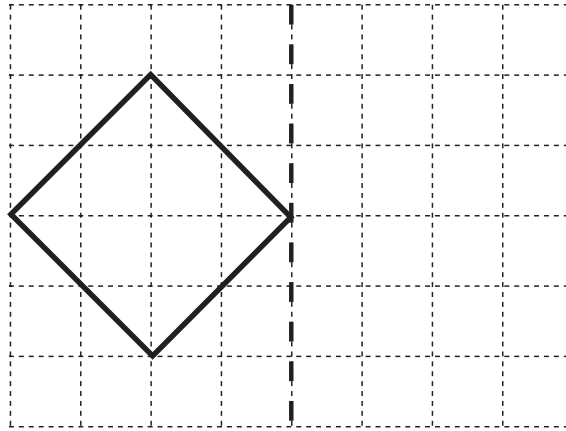

c)

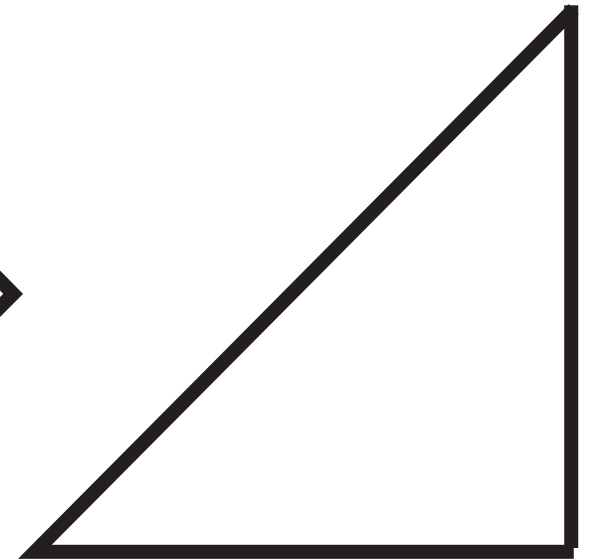
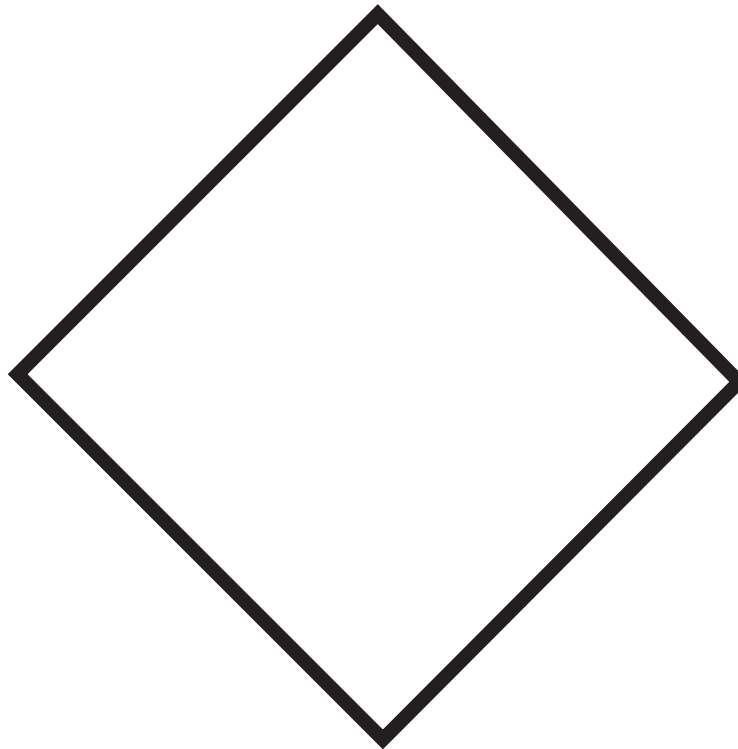
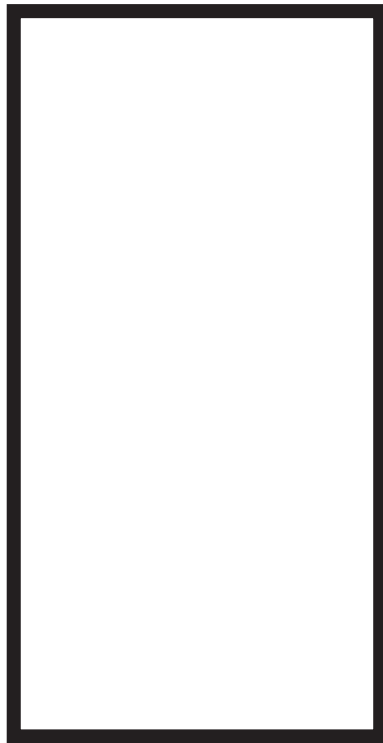
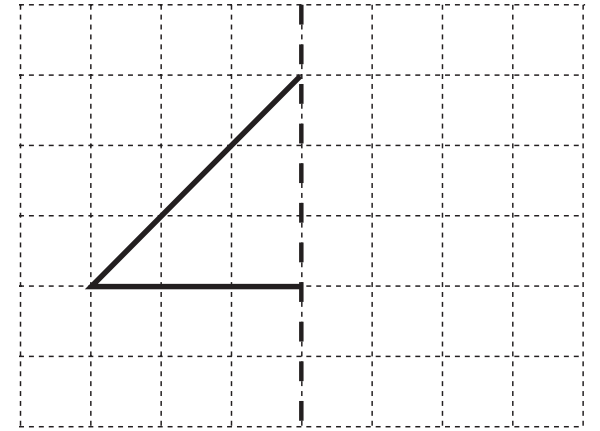

<i>C</i>	541			1014	
<i>J</i>		541			1014
<i>L</i>			541		1014

LP 90/1

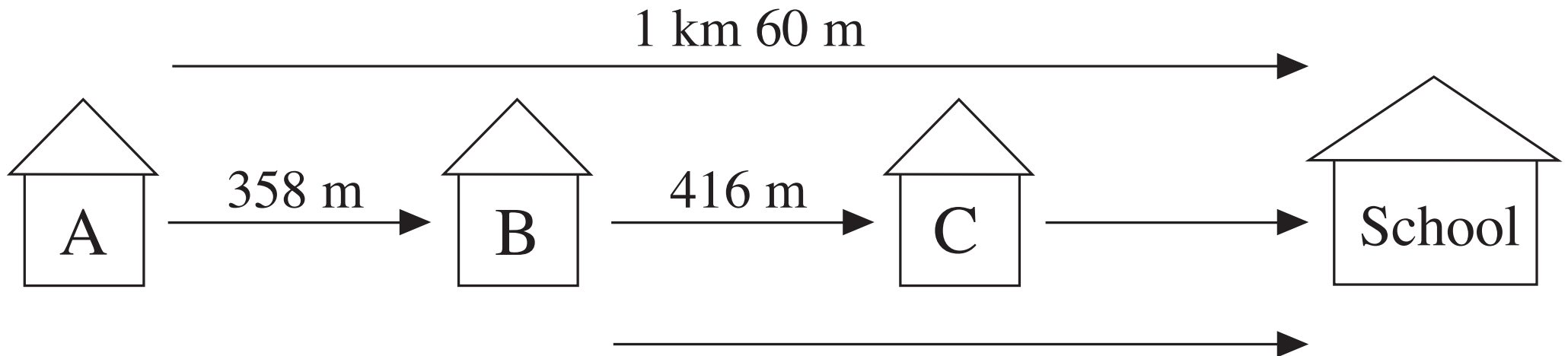

LP 90/2



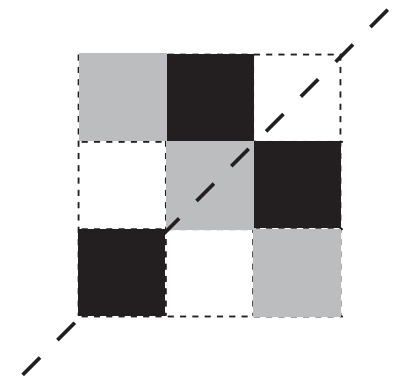
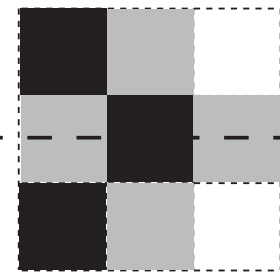
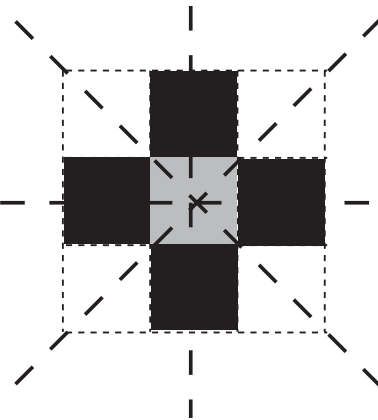
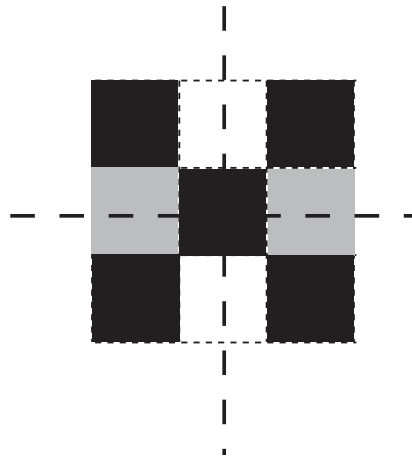
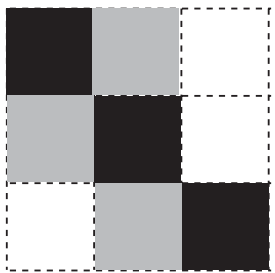
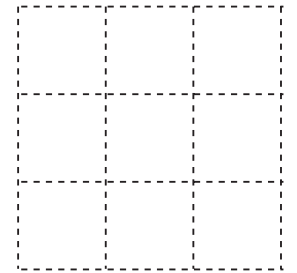
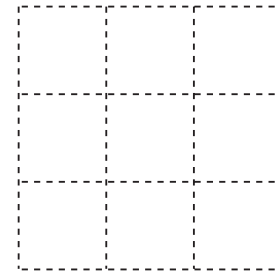
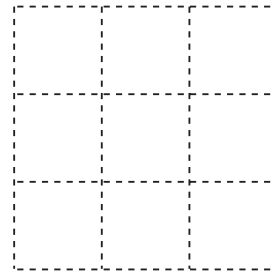
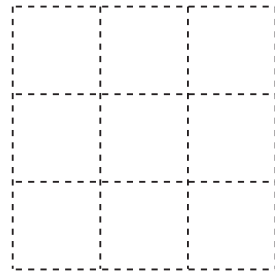
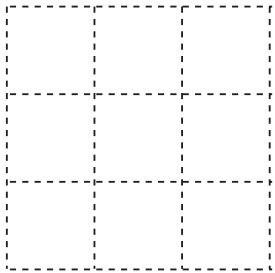
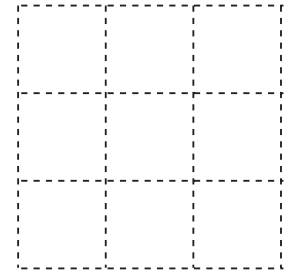
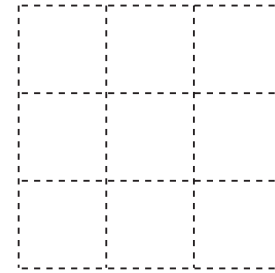
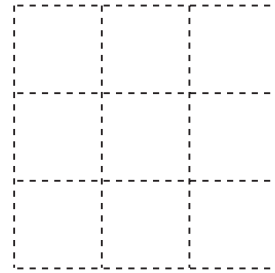
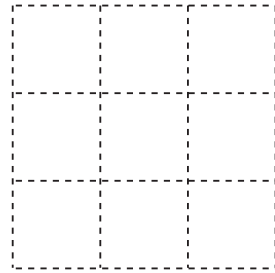
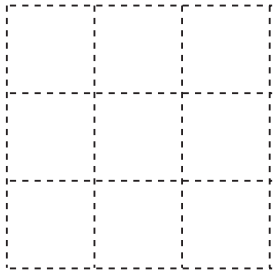
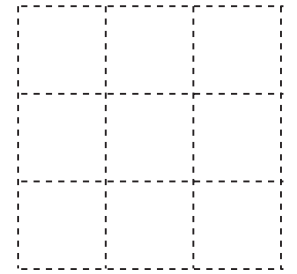
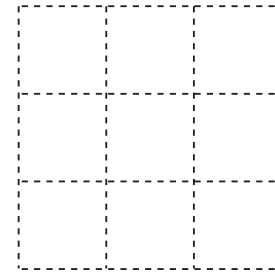
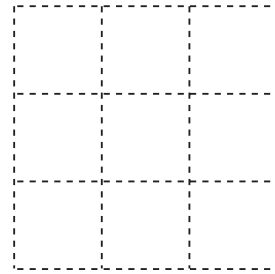
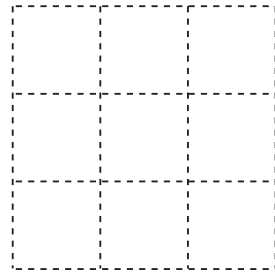
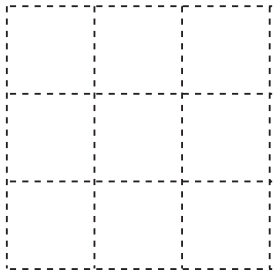

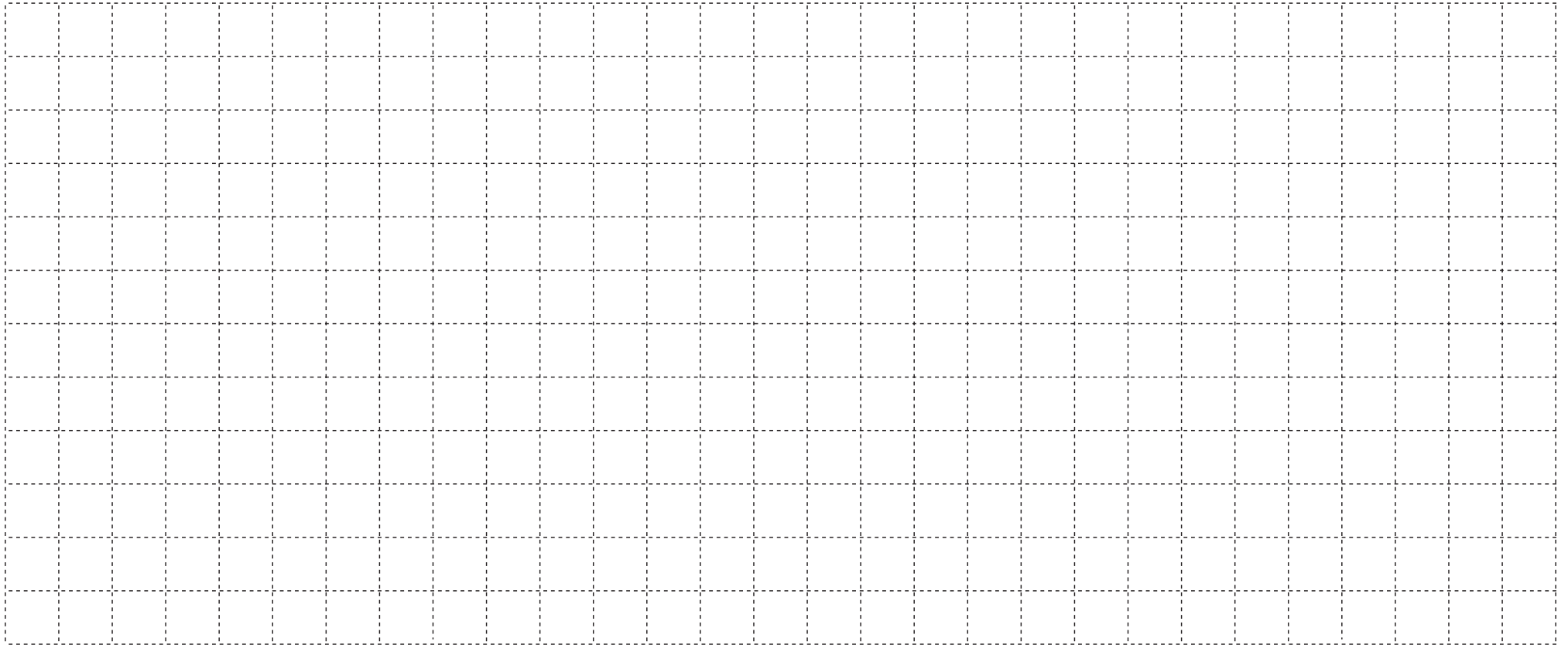

a)

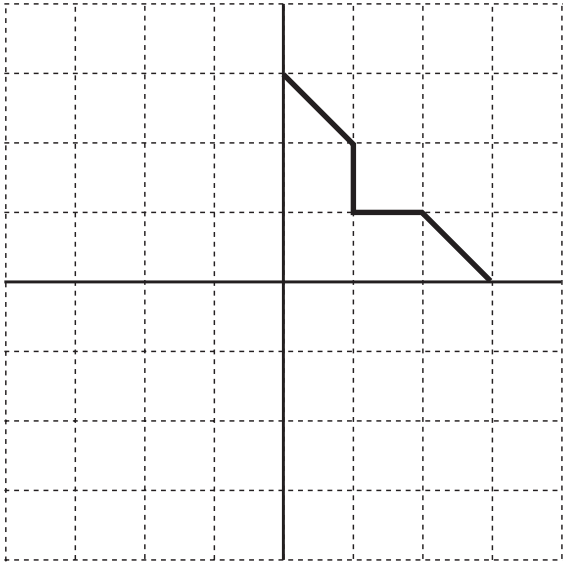

b)

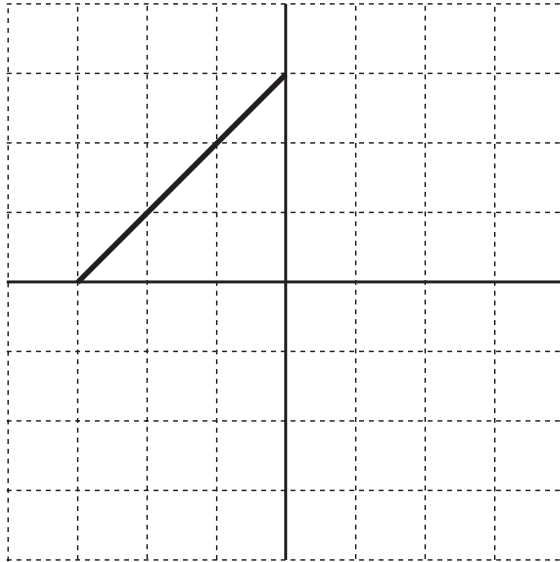

c)

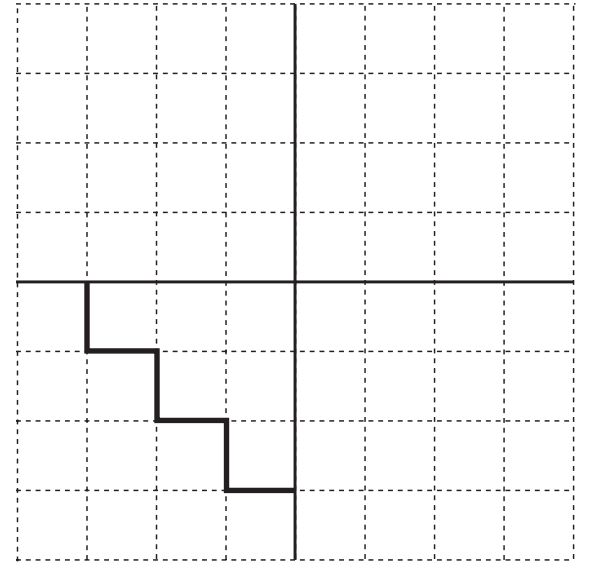

d)

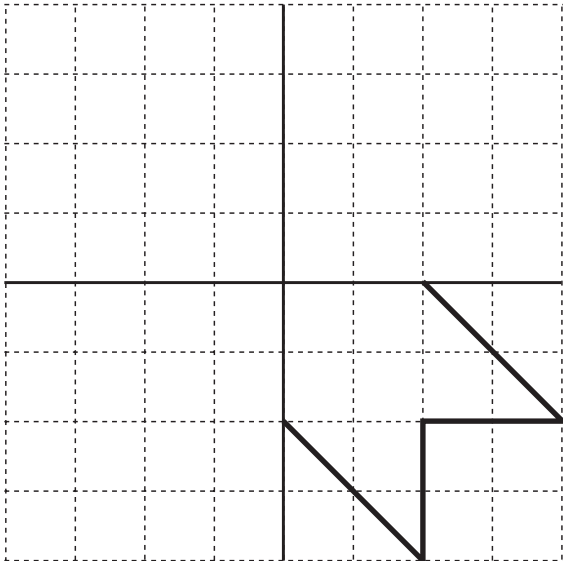

e)

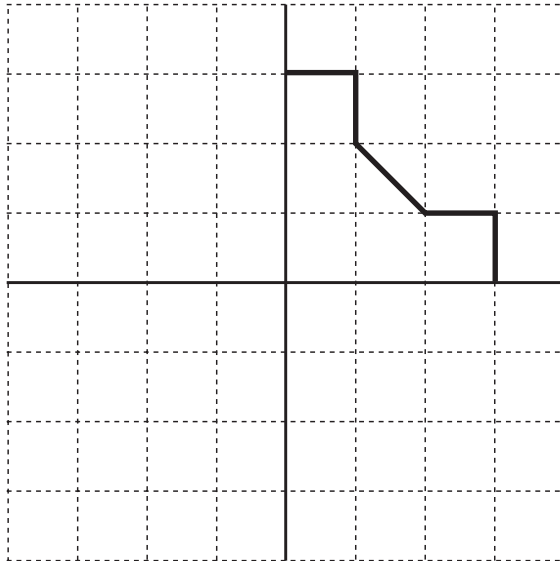

f)

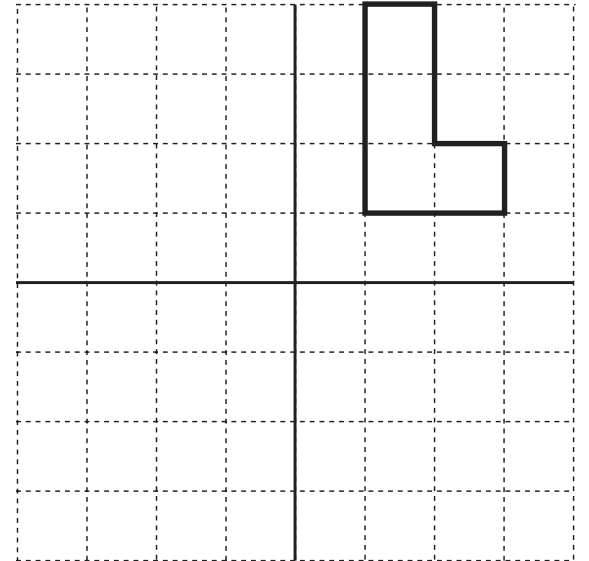

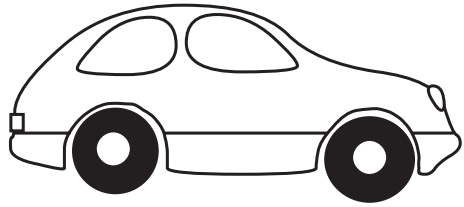

£6.75



£3.32

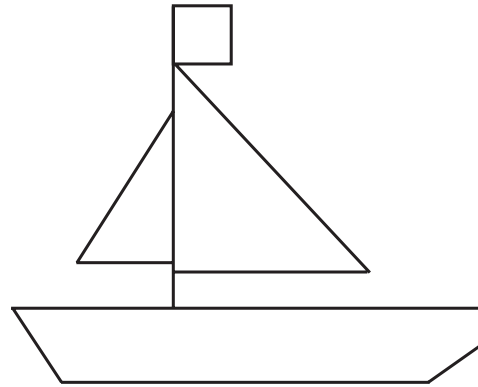

£8.54

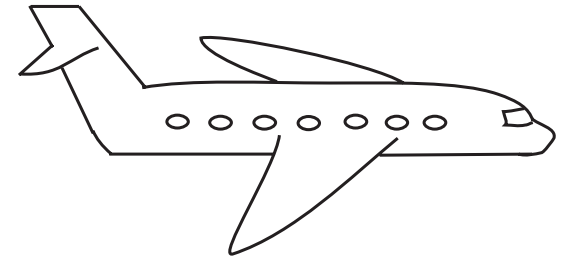

£4.99

LP 91/1

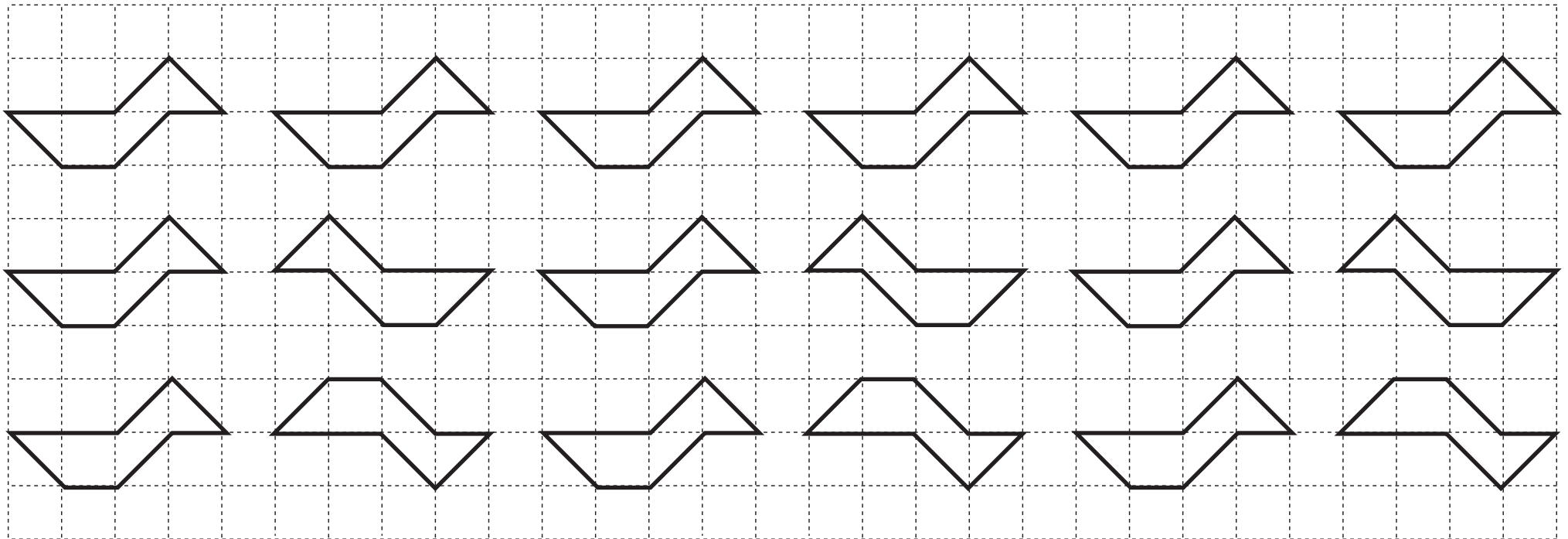

LP 91/5



a)

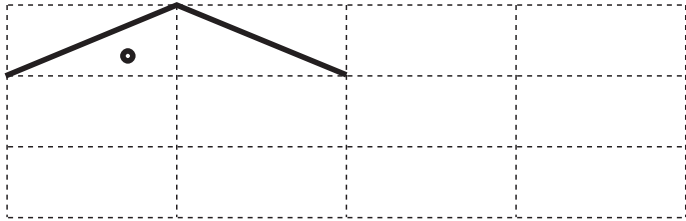

b)

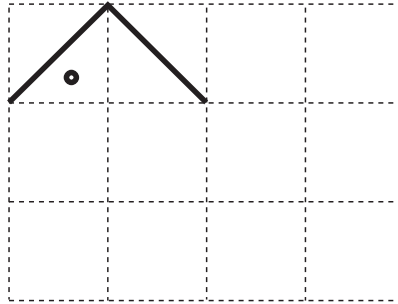

c)

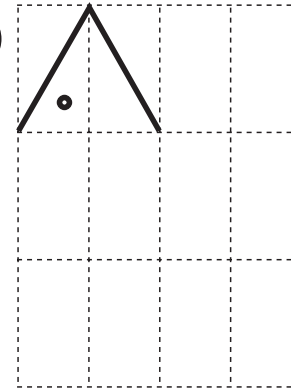

d)

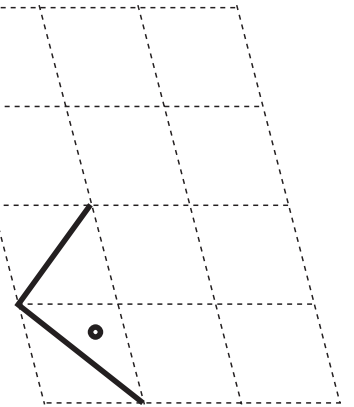

LP 91/7

a)

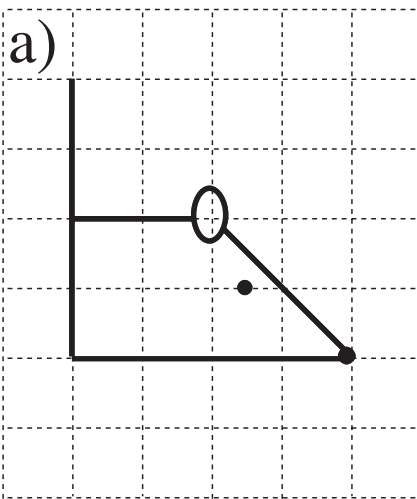

b)

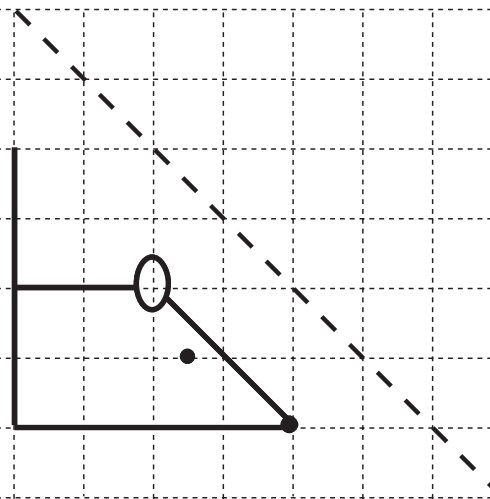

c)

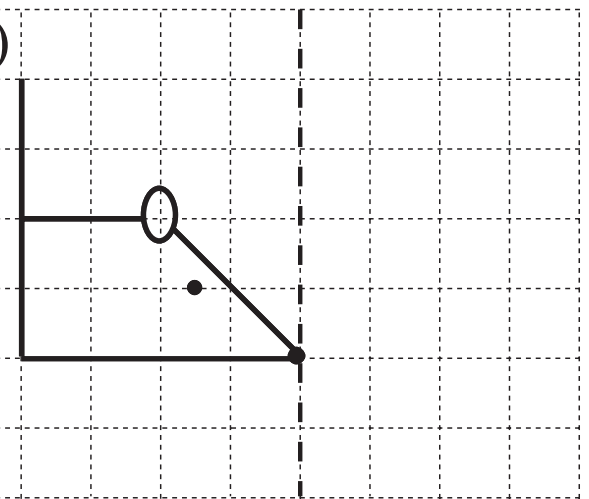

LP 91/8a

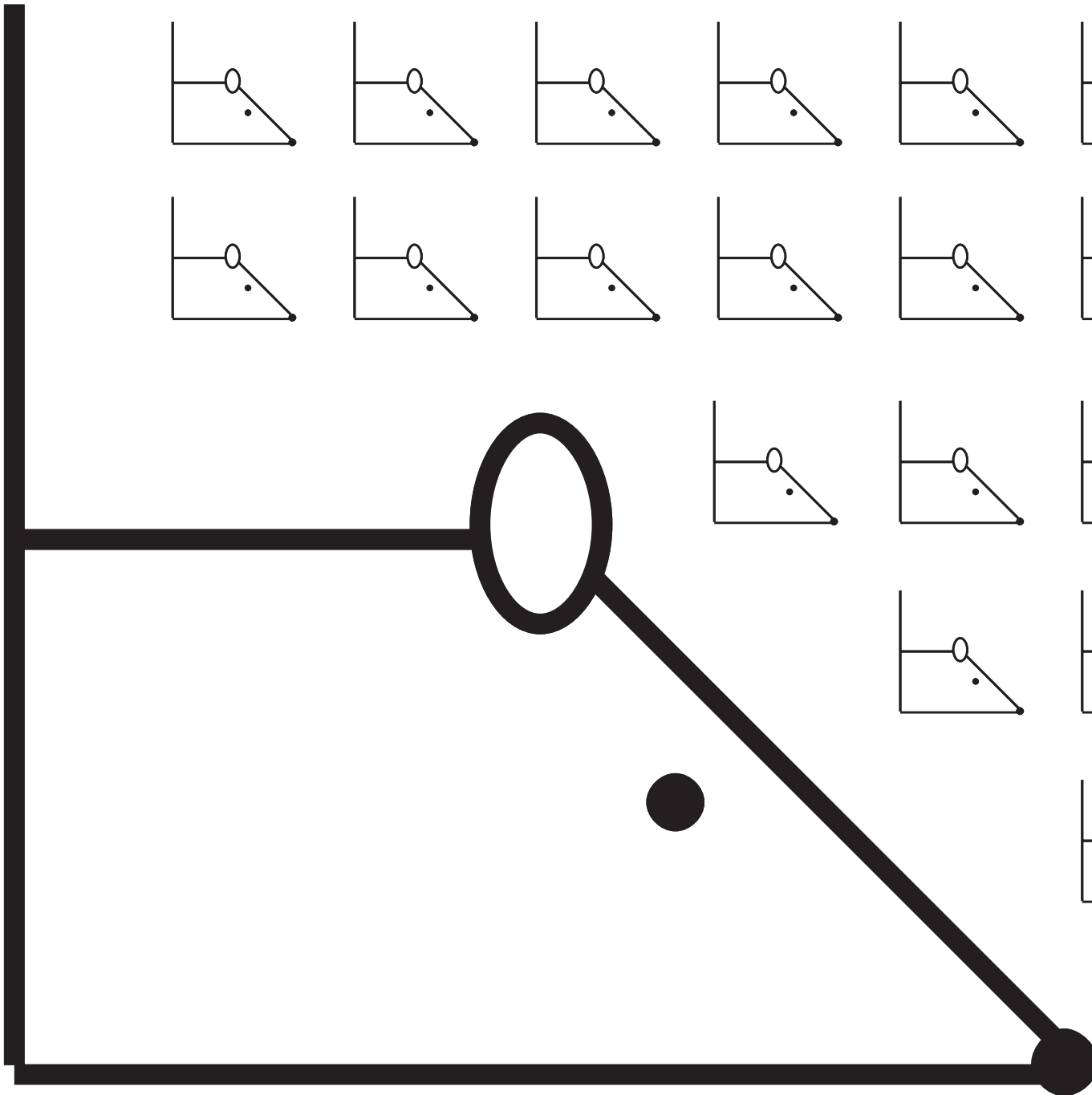
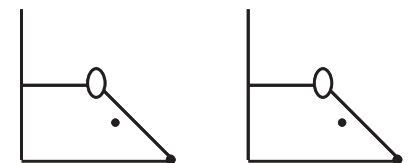
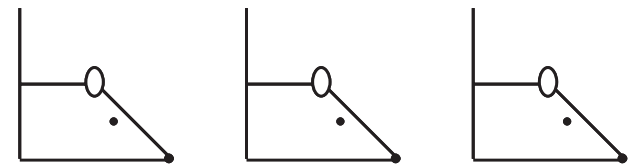
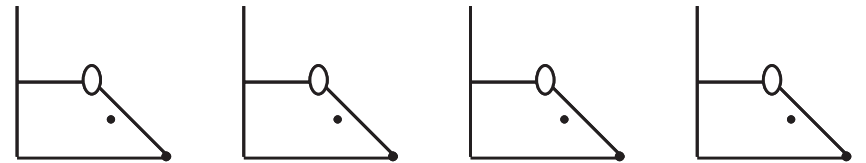
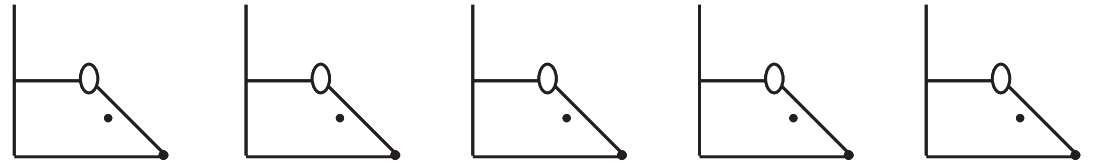
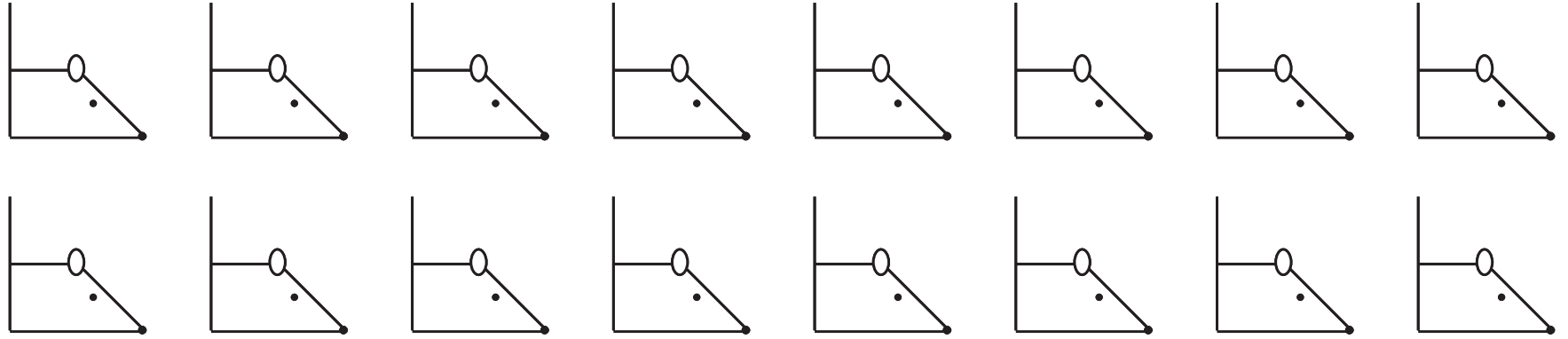

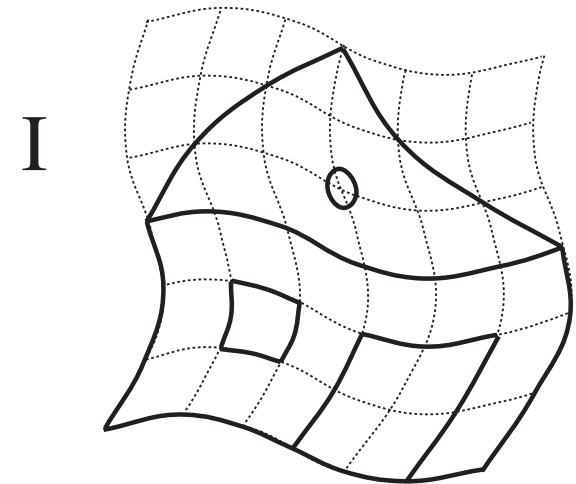
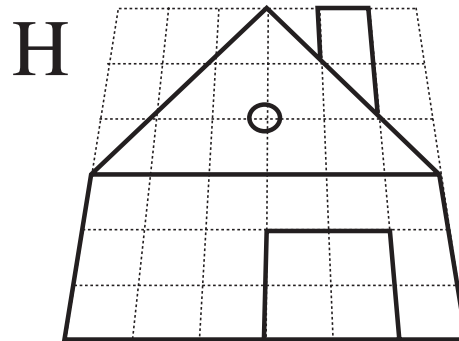
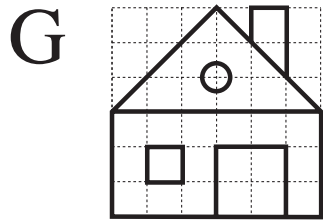
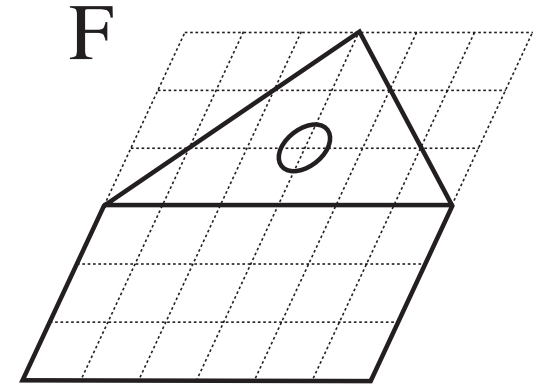
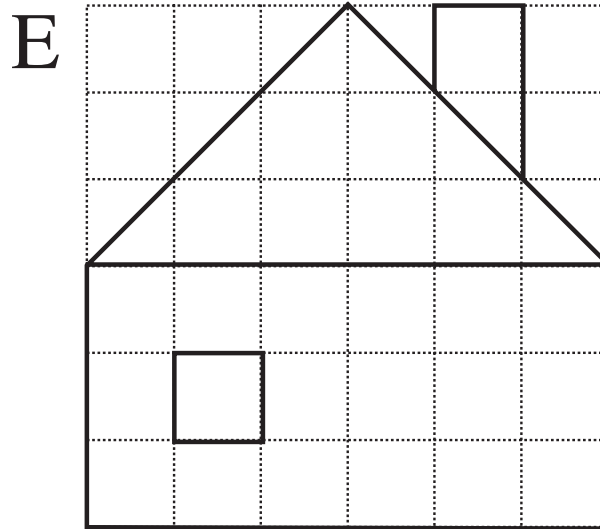
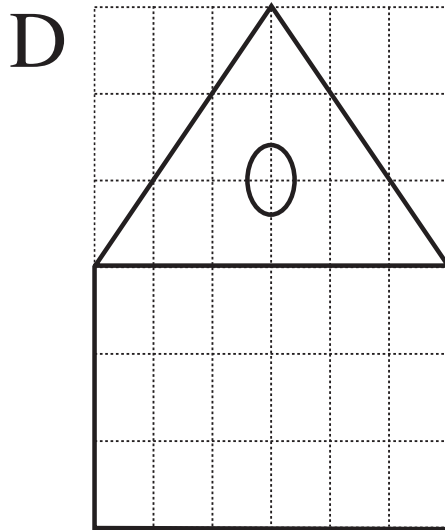
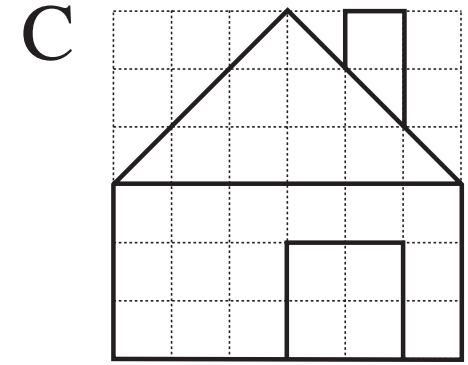
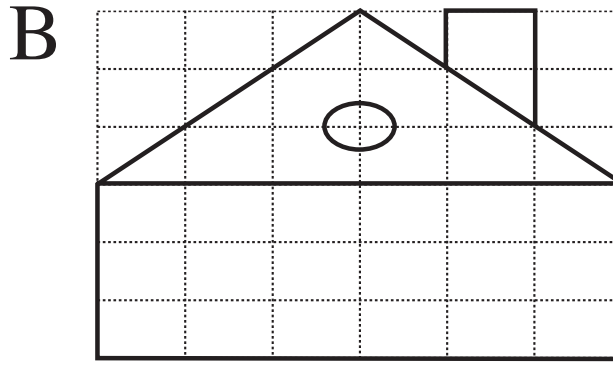
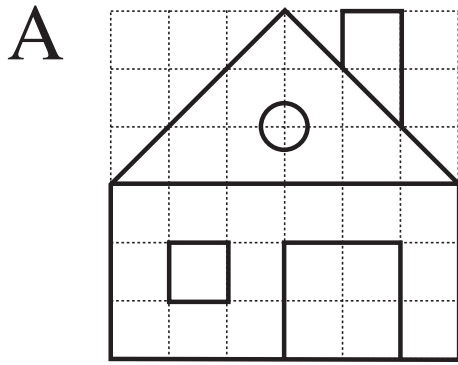



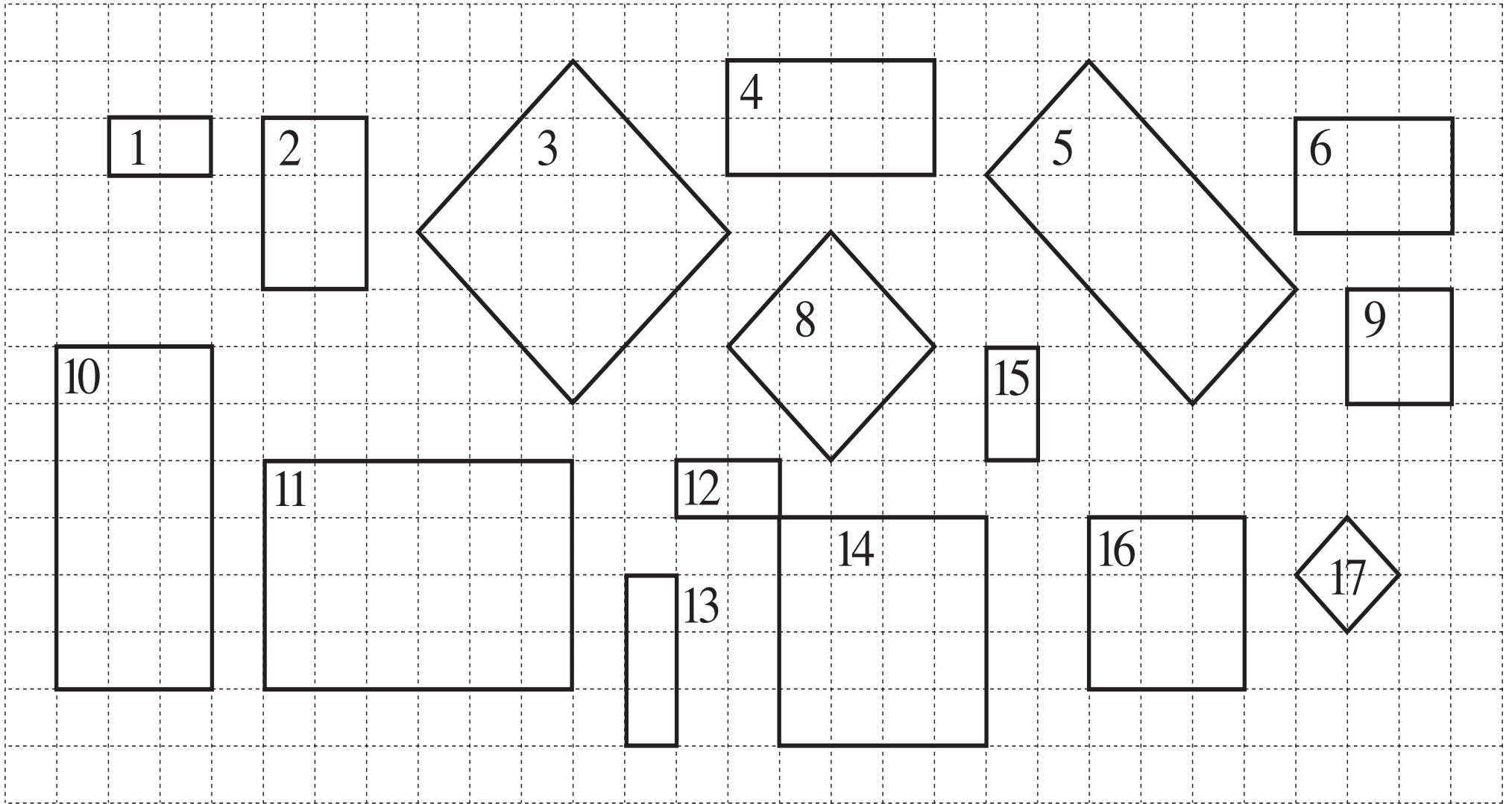

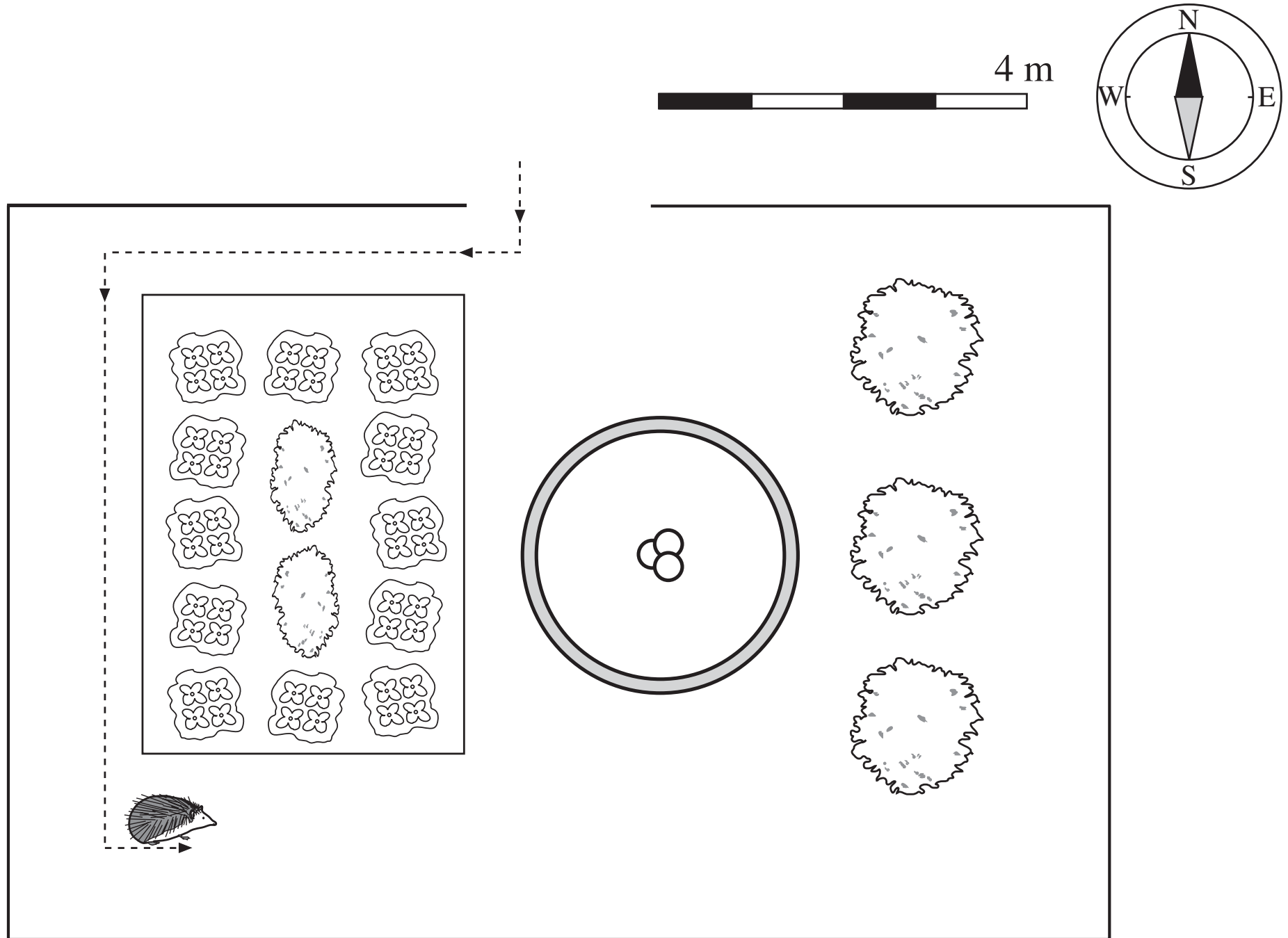

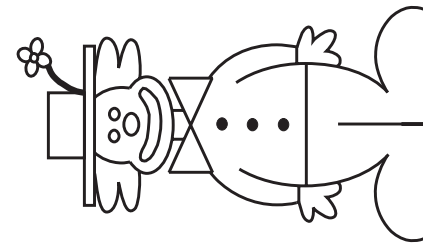
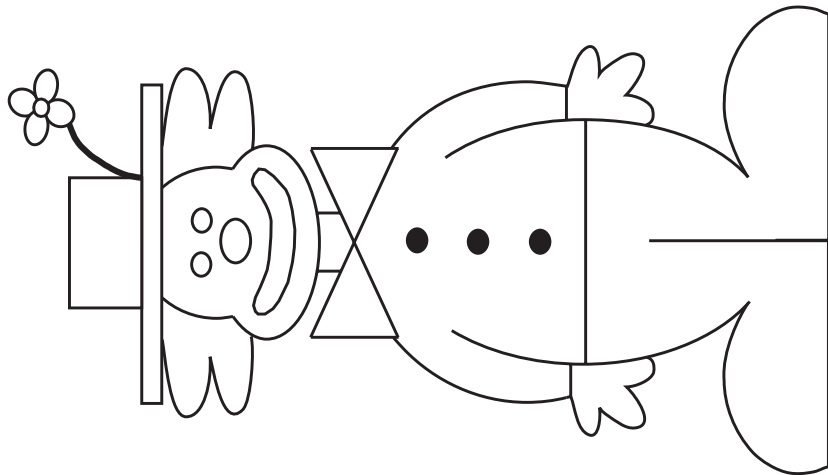
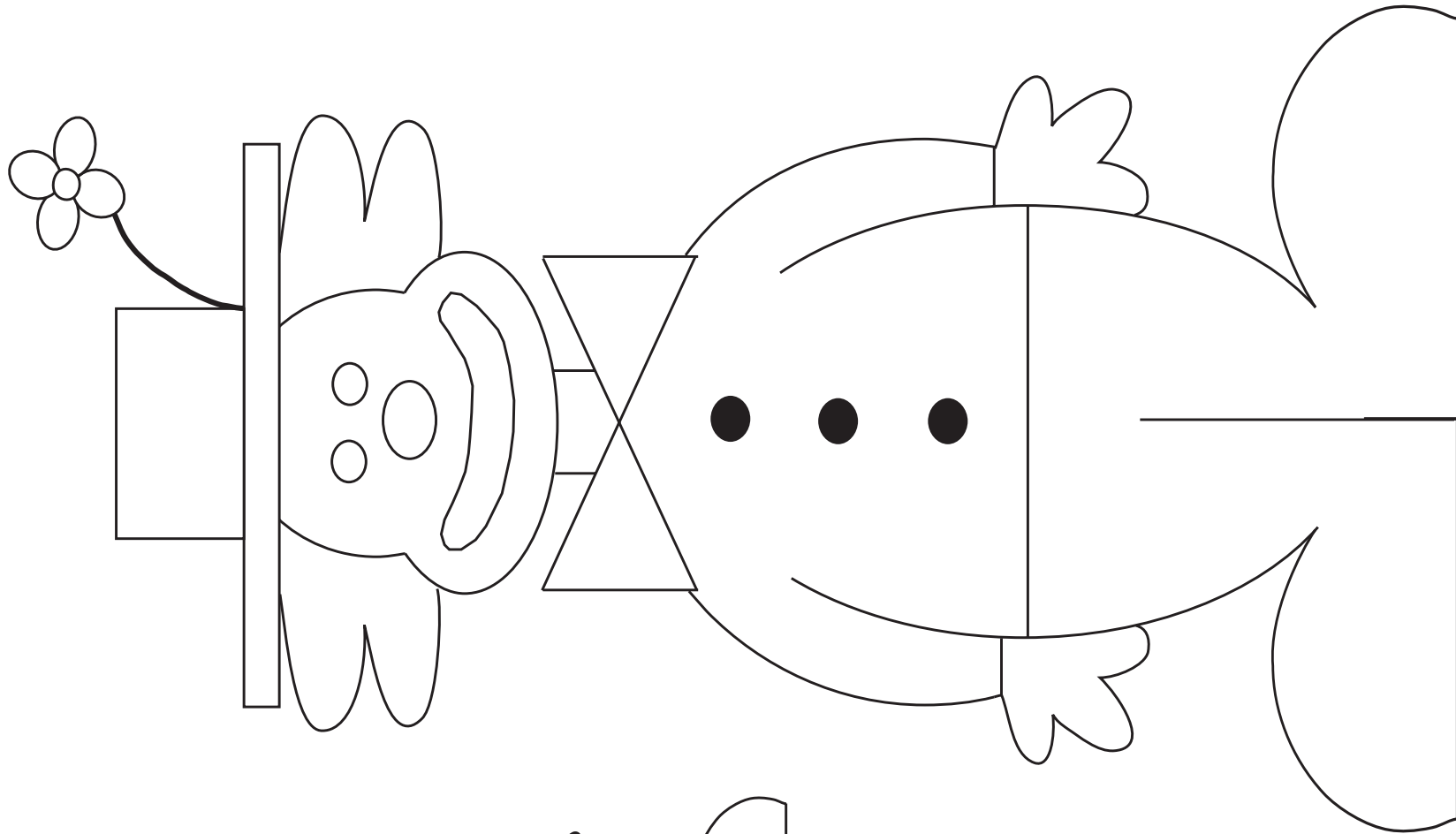

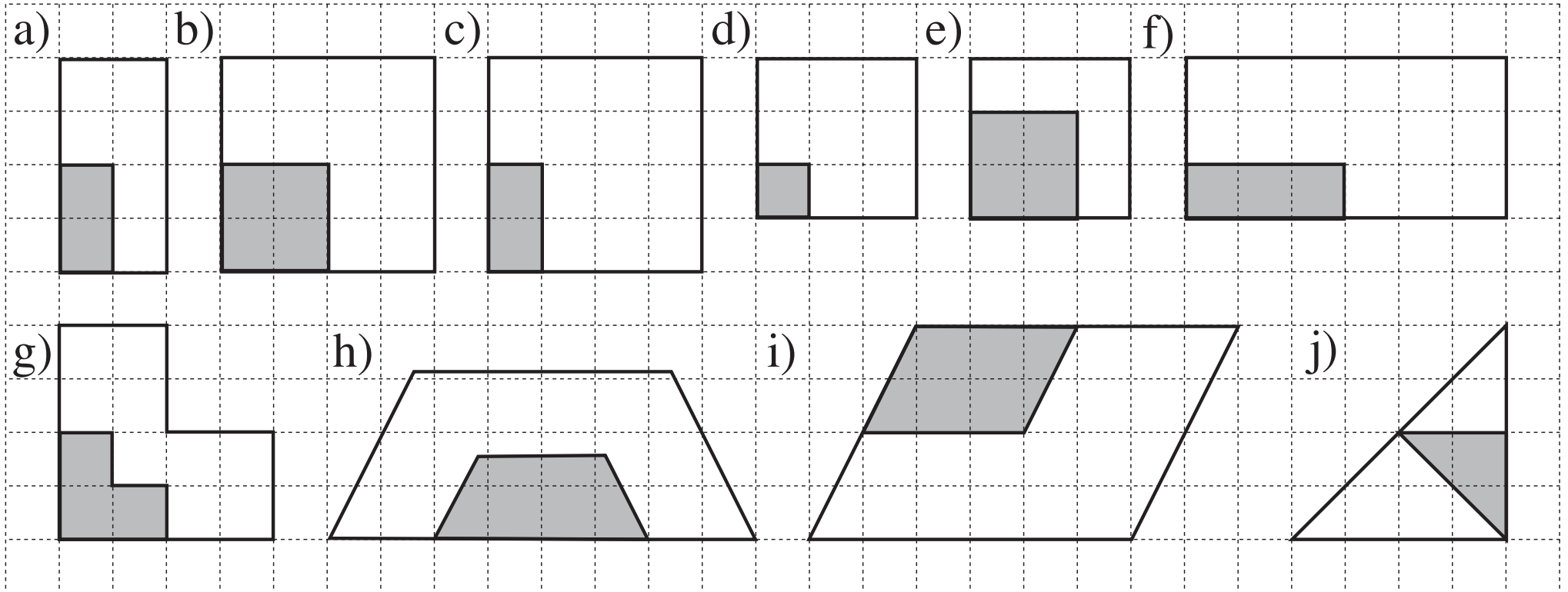

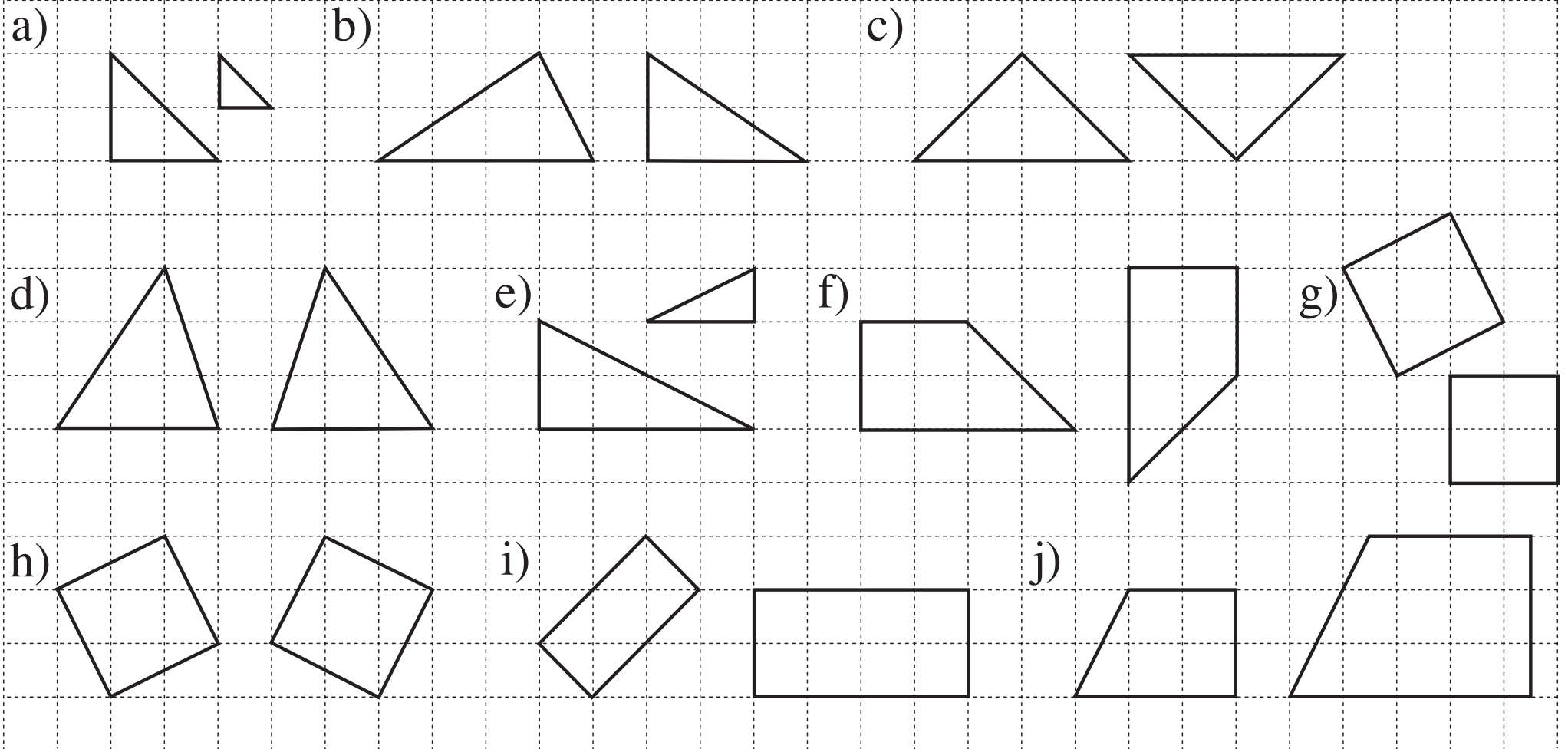

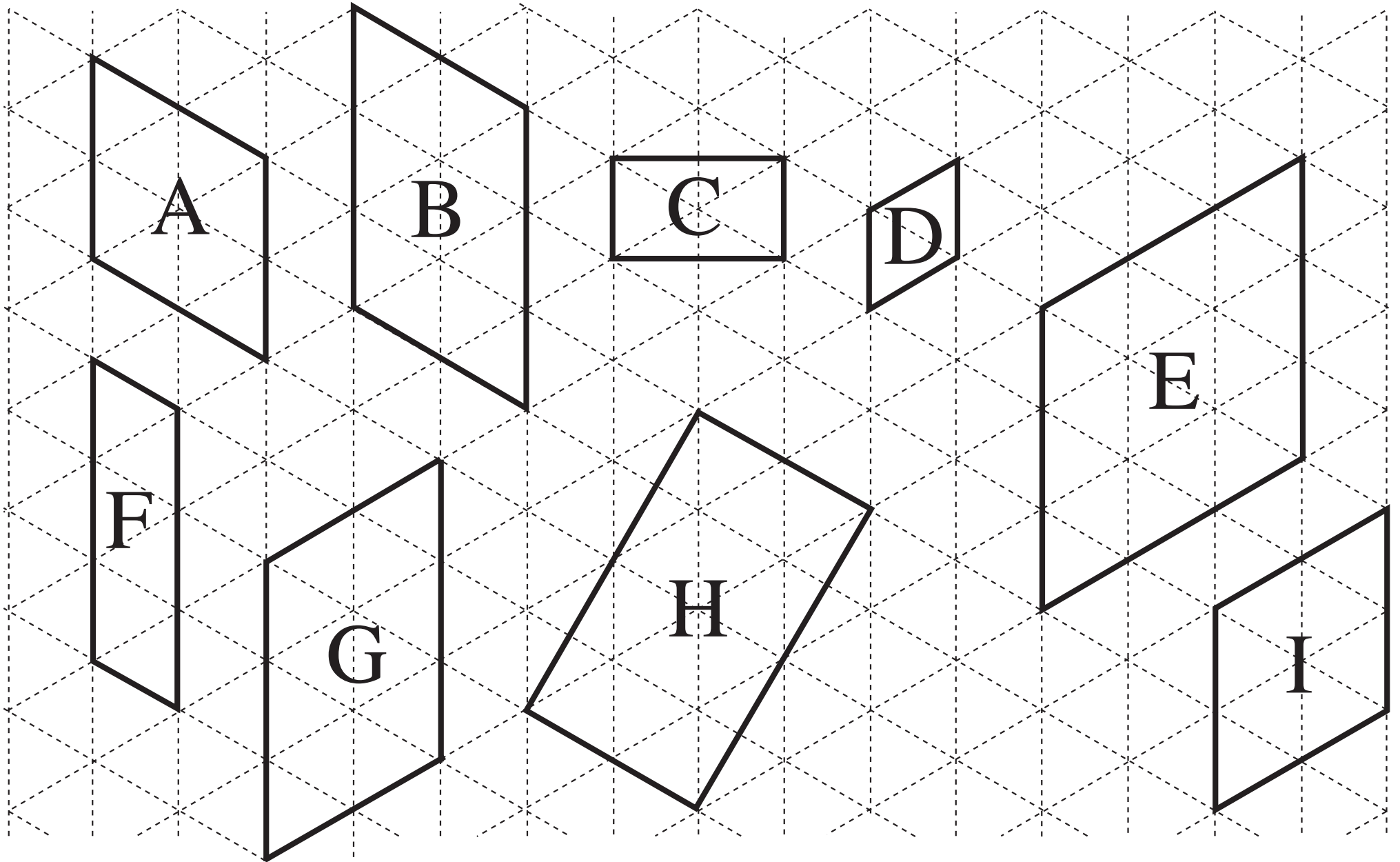

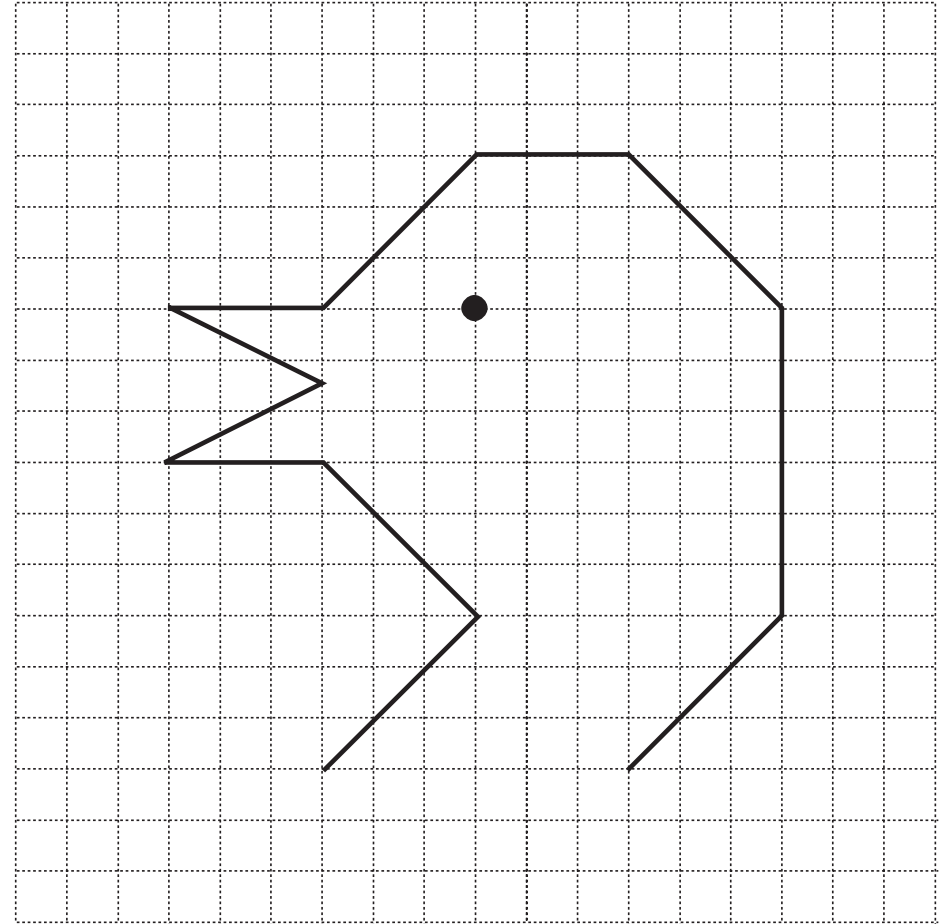
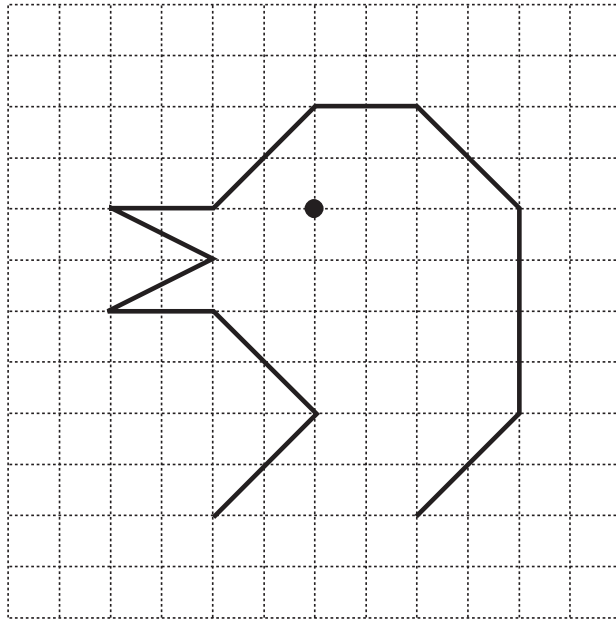
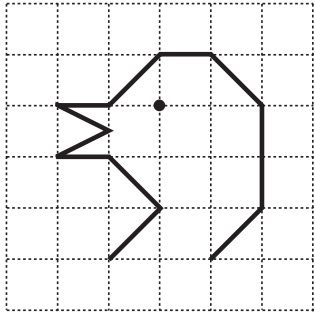

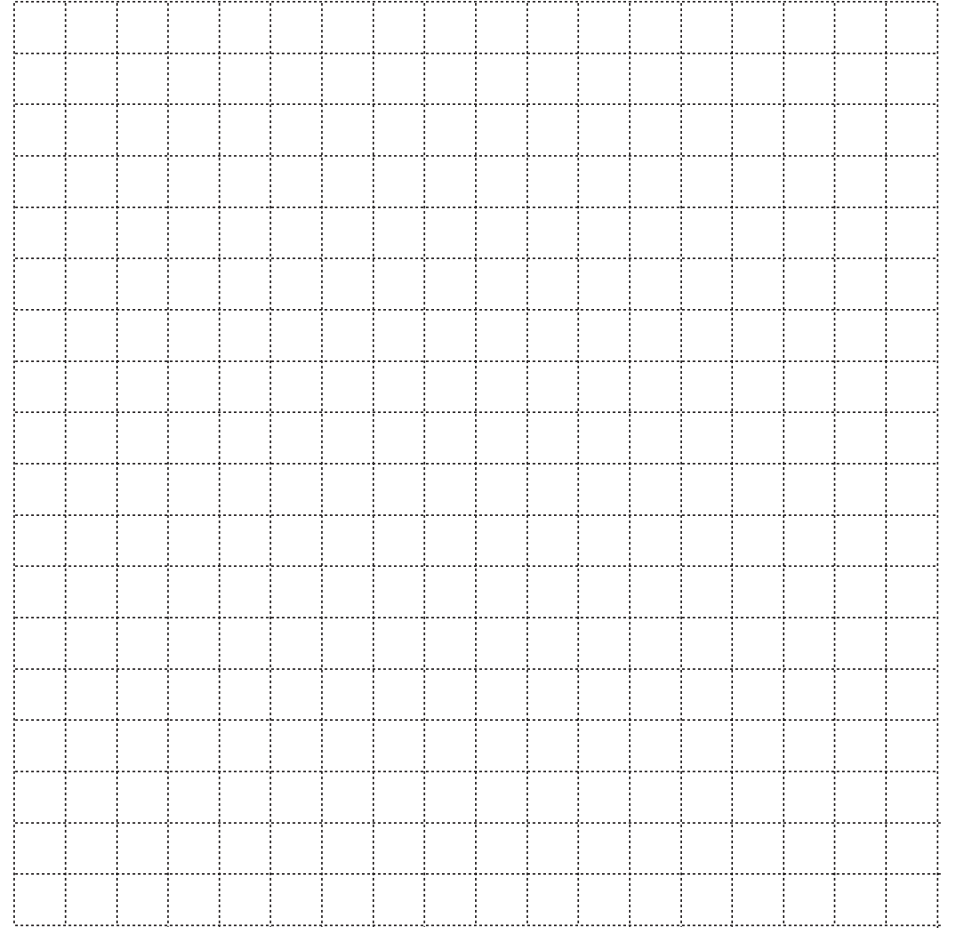
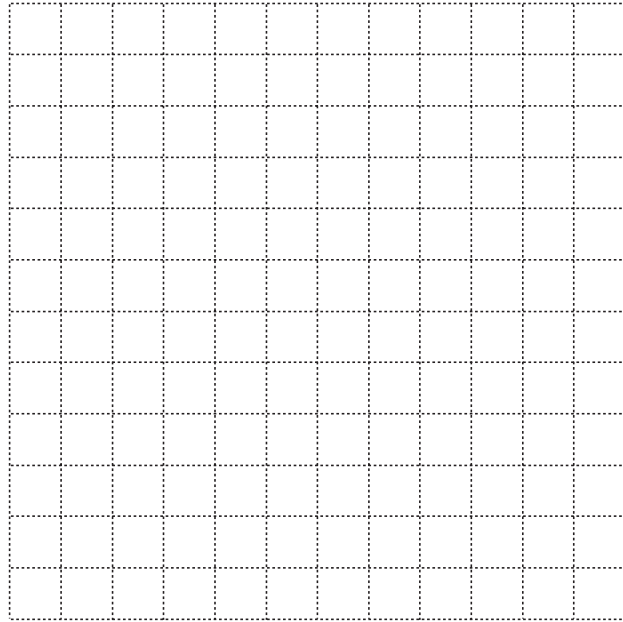



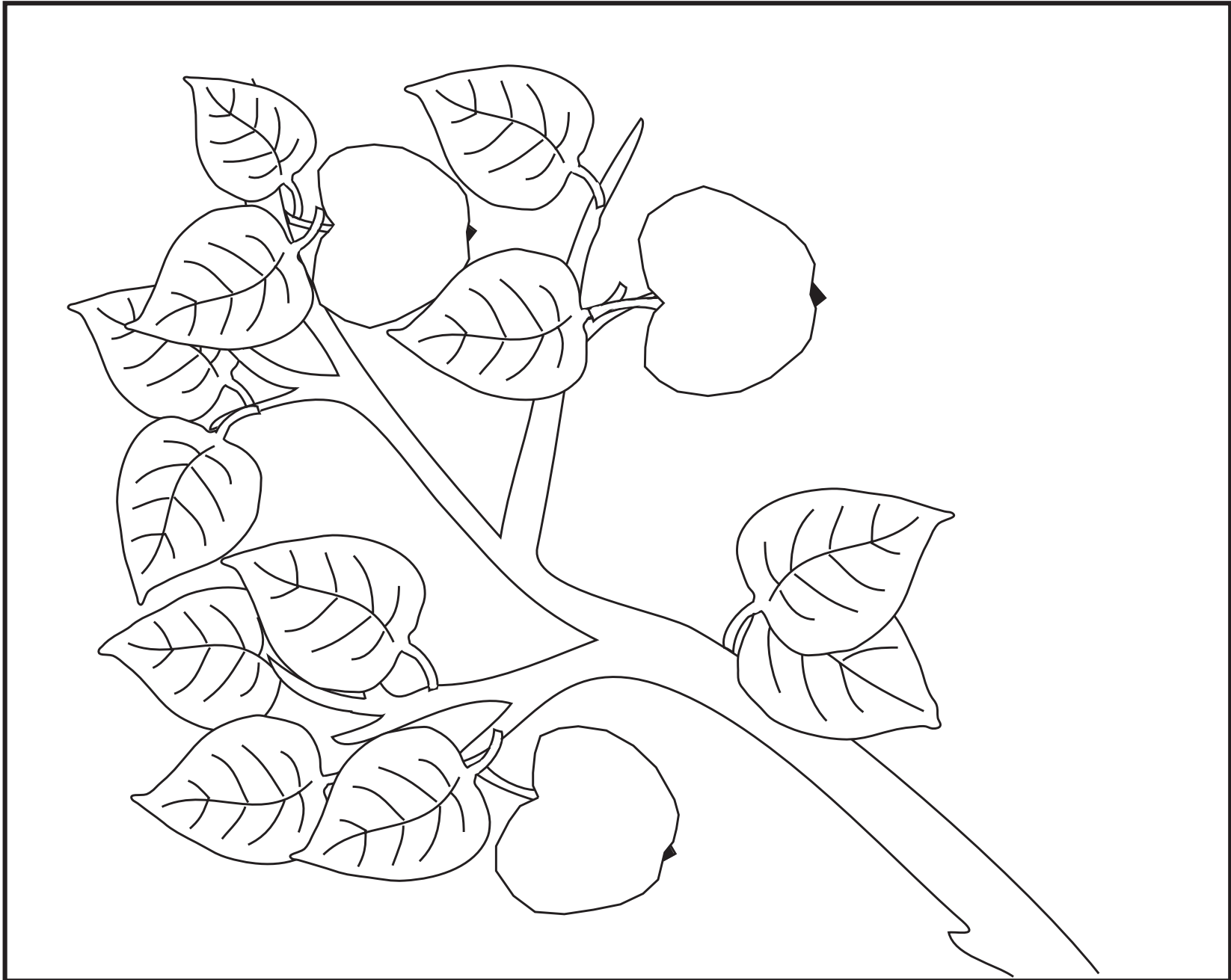

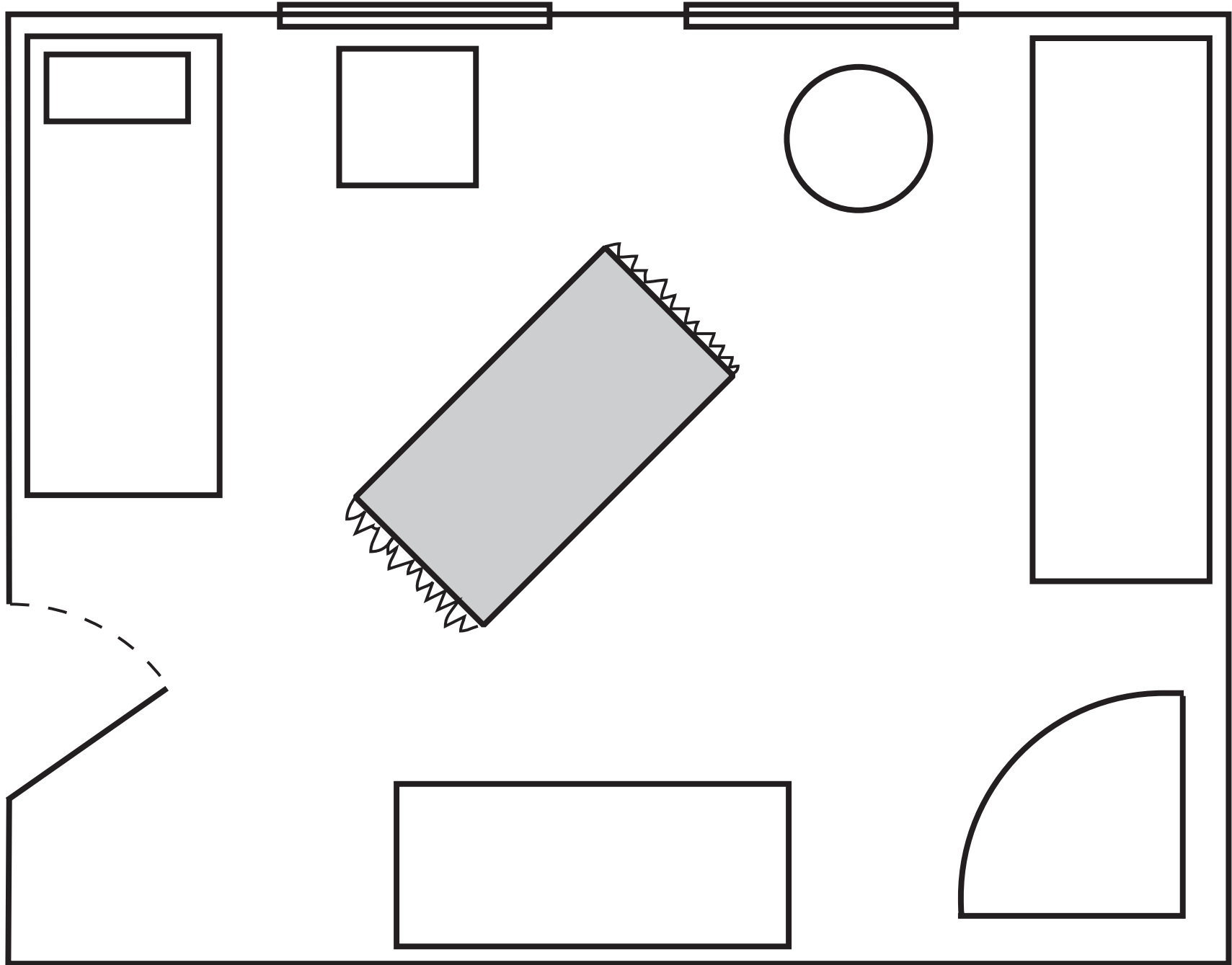

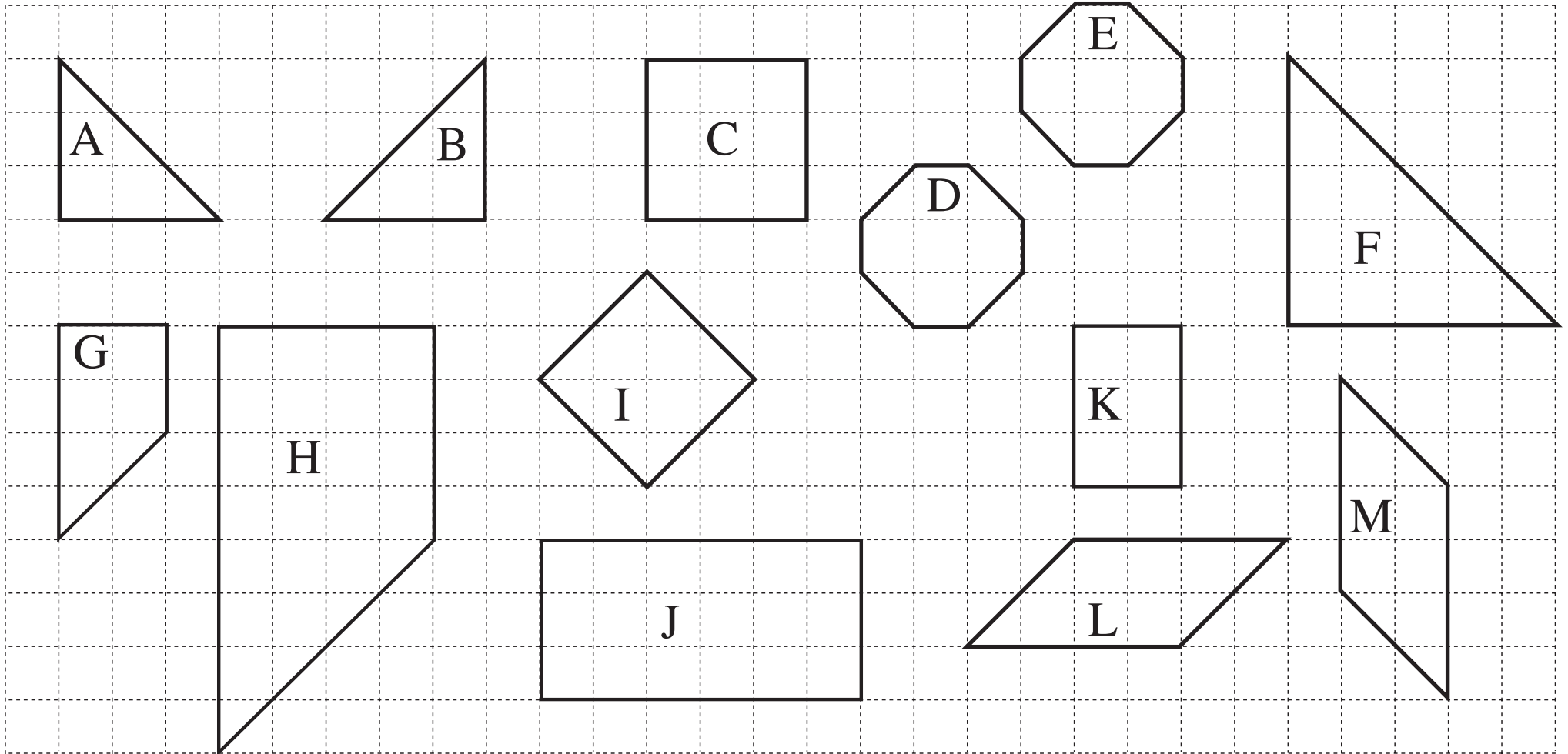

a) i)

+	3	4	2
+			
+	5	8	9

ii)

	5	4	6
+			
+	1	3	7
+			6

iii)

	4	0	3
+			
+	9	4	3

iv)

	9	9	9
+			
+	1	8	8
+			8

v)

	3		2
+		4	6
+	2	5	

vi)

1		8
+		0
+	2	4
+		3

b) i)

	9	5	6
-			
-	6	1	4

ii)

	7	4	3
-			
-	1	5	2

iii)

-		
-	5	2
-		6
-	3	1
-		2

iv)

-		
-	4	7
-		9
-	2	1
-		8

v)

	8	5	
-			
-		3	4
-	6		2

vi)

7		1
-		
-	5	9
-		
-	5	2

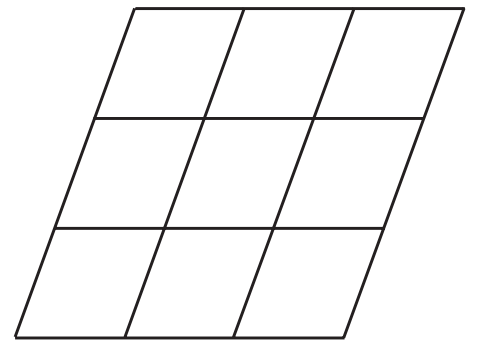
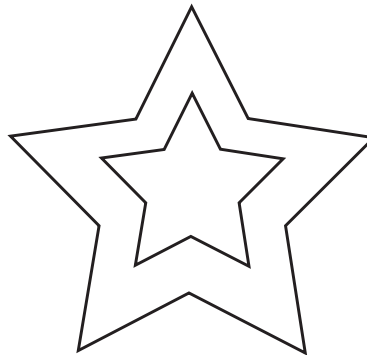
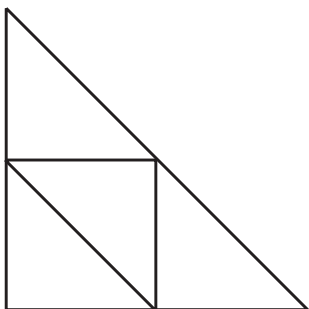
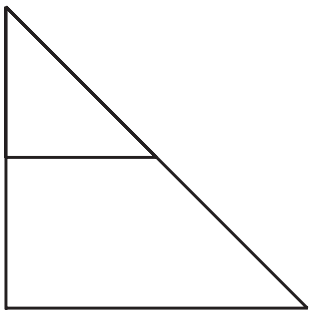
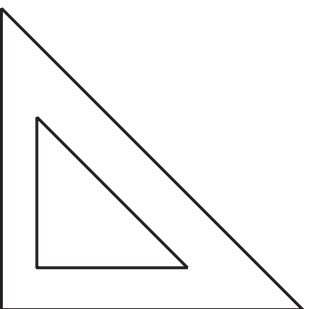
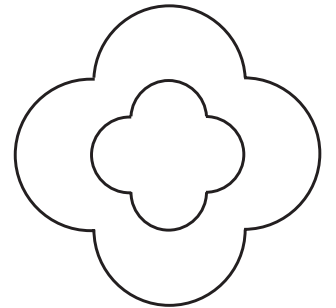
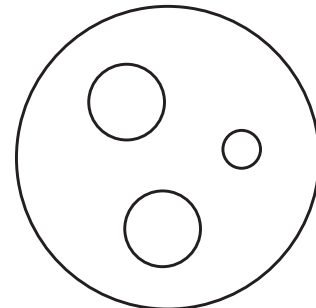
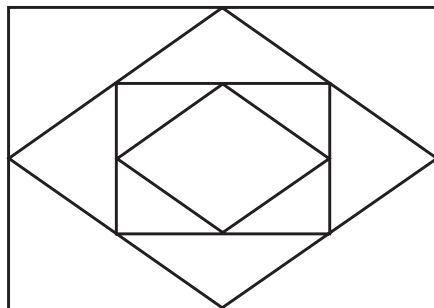
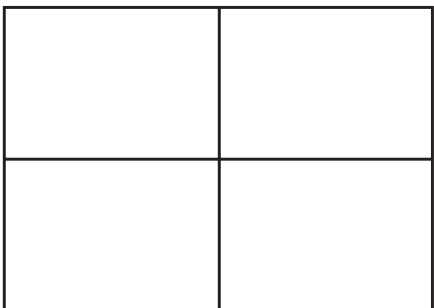
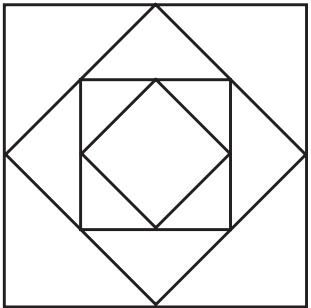
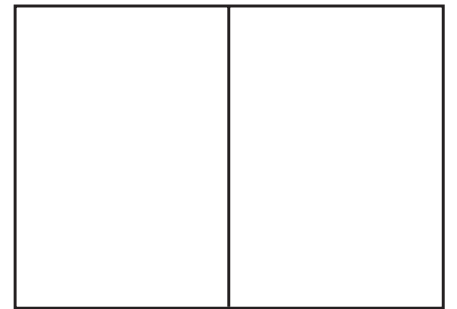
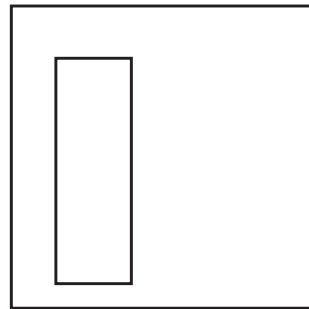
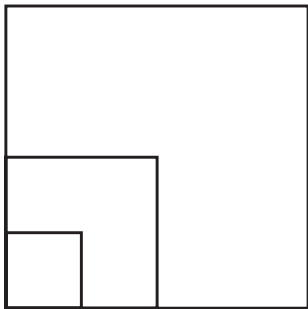
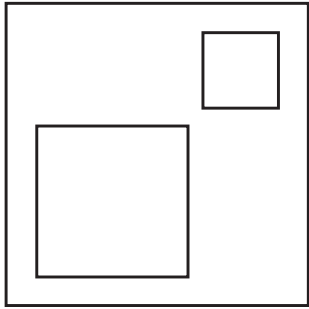
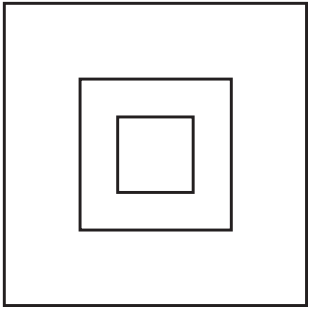

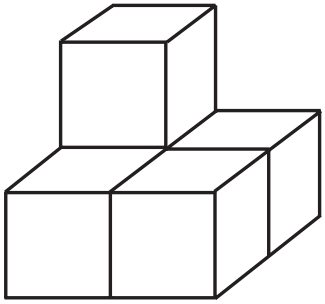

2	1
1	1

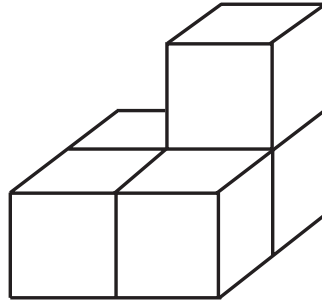

1	2
1	1

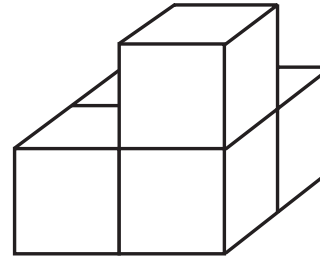

1	1
1	2

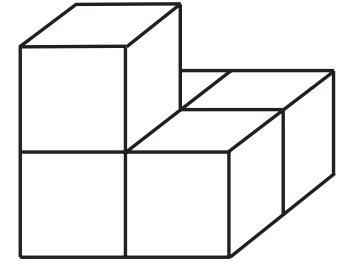

1	1
2	1

LP 95/6

<i>Solids</i>	a)	b)	c)	d)	e)
<i>Volume</i> (unit cubes)					
<i>Area</i> (unit squares)					

LP 95/7b

a)

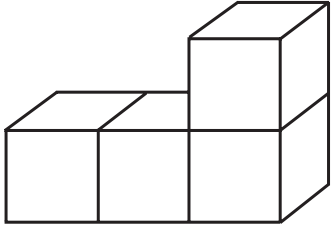

unit cubes

b)

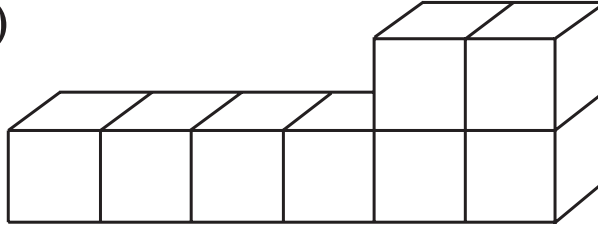

unit cubes

c)

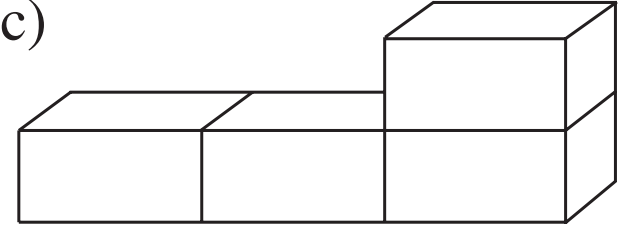

2-unit cuboids

d)

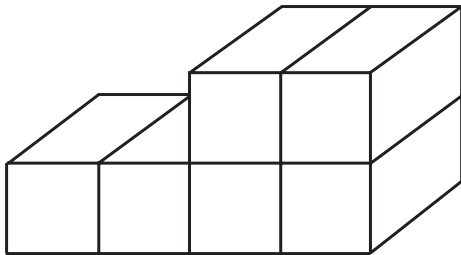

2-unit cuboids

e)

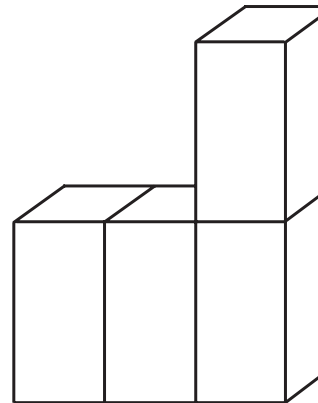

2-unit cuboids

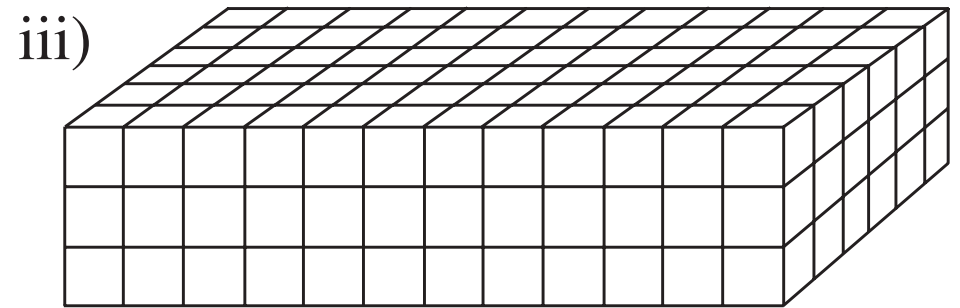
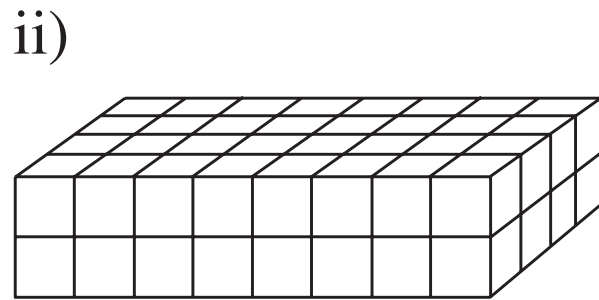
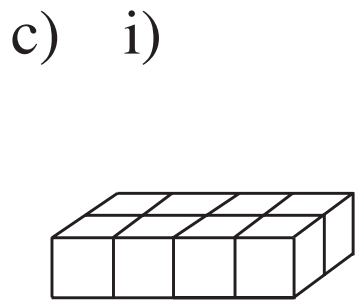
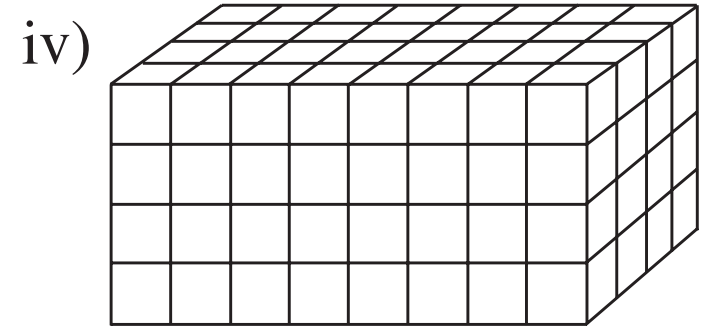
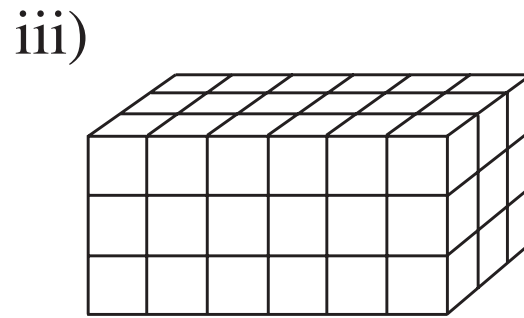
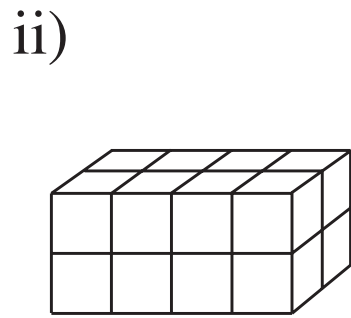
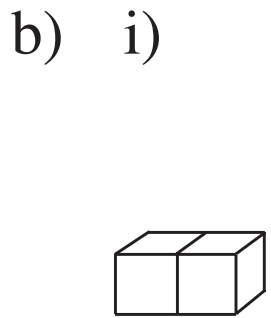
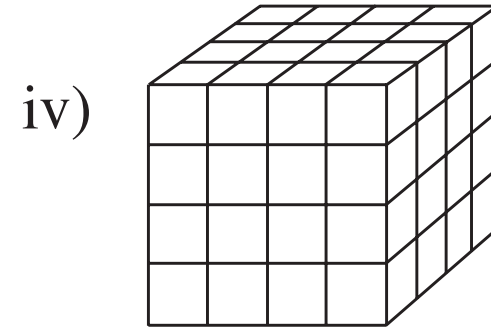
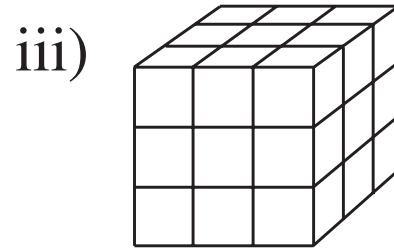
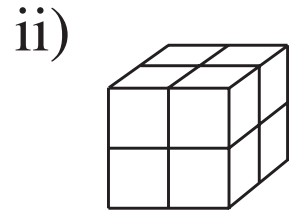
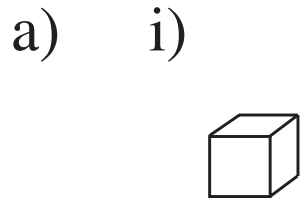



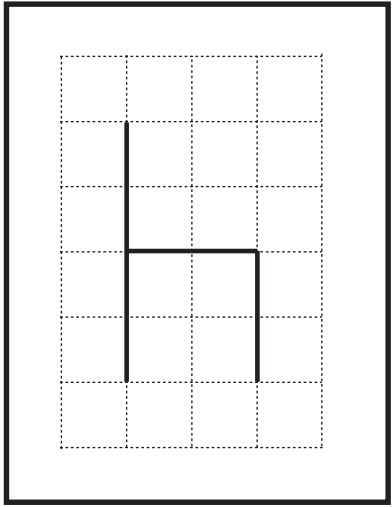

a)

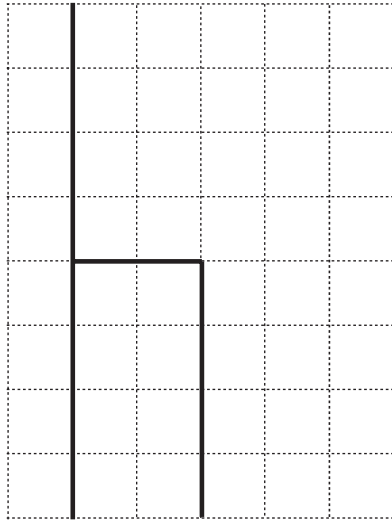

b)

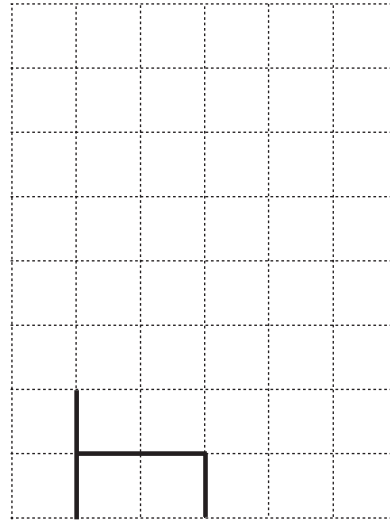

c)

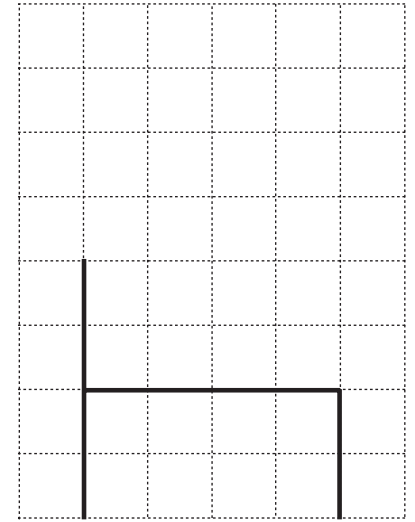

d)

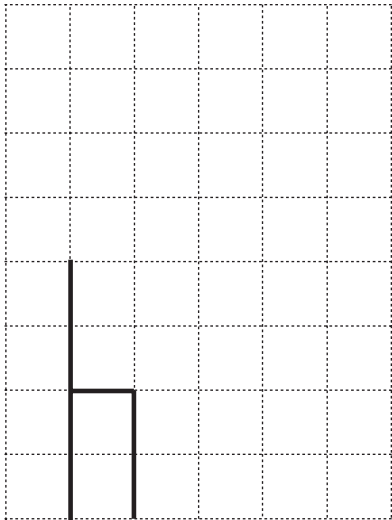

e)

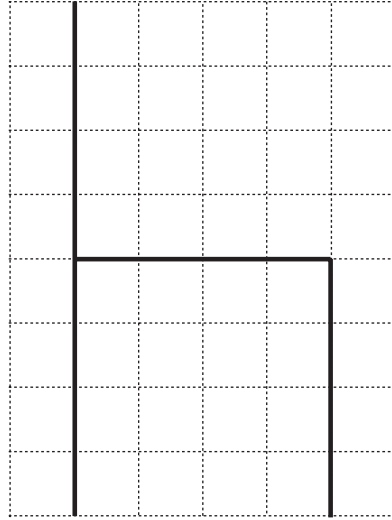

f)

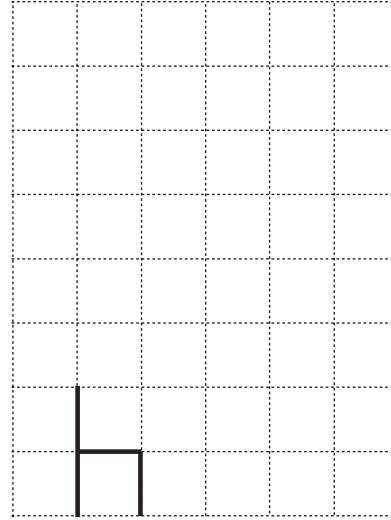

g)

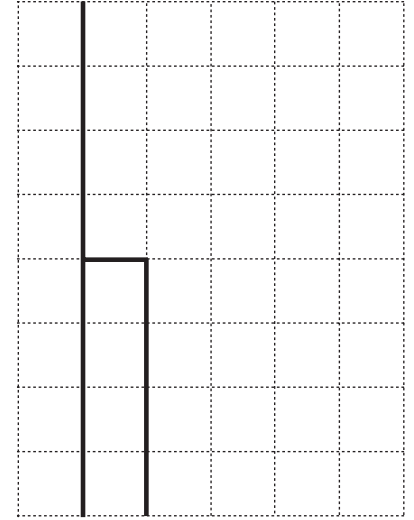

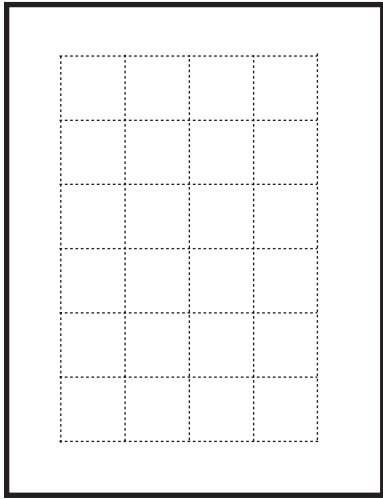

a)

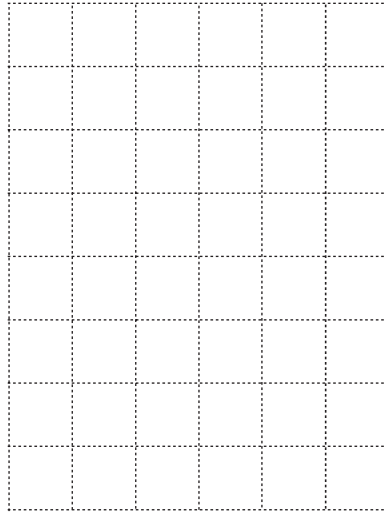

b)

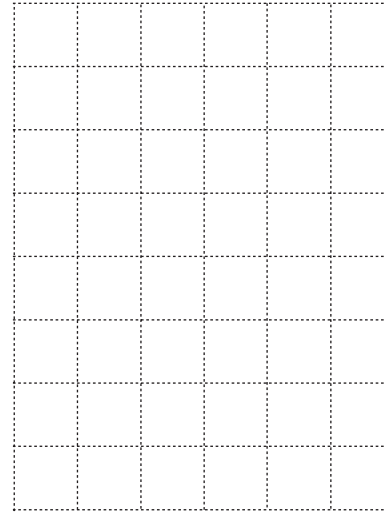

c)

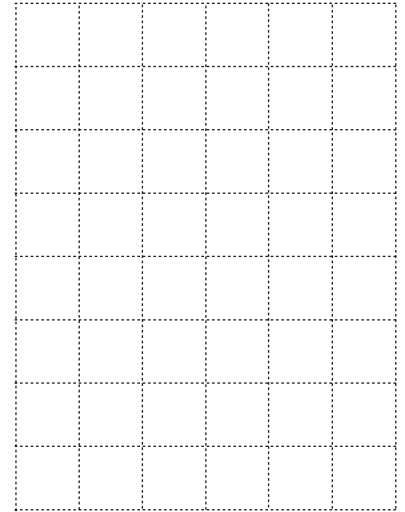

d)

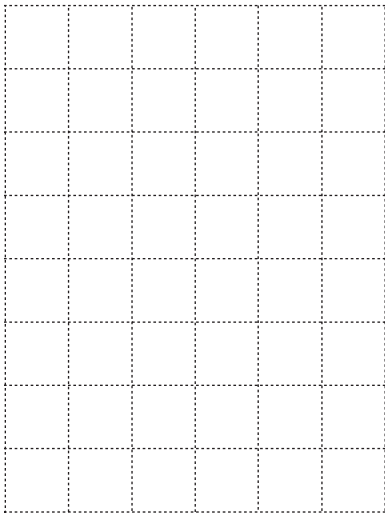

e)

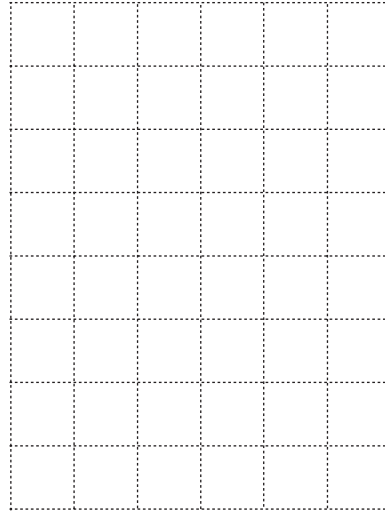

f)

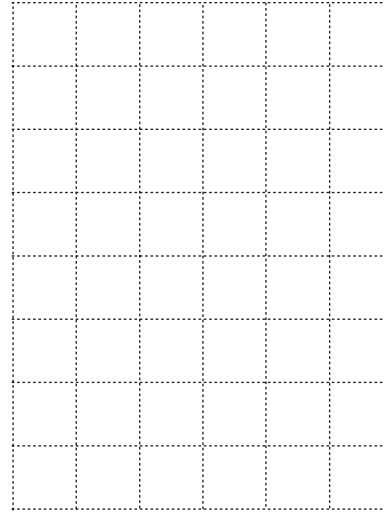

g)

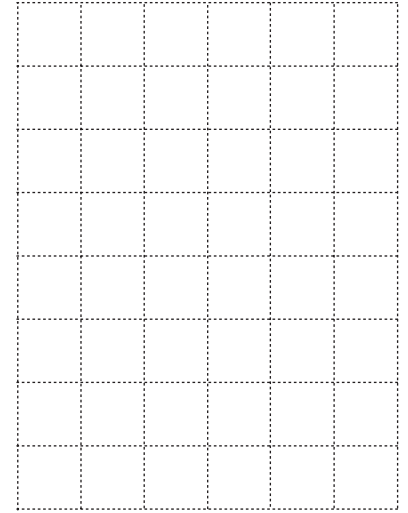

a) Top view      Ground plan      Front view      Side view

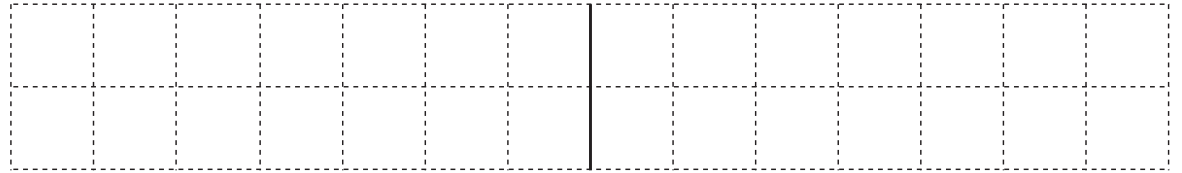
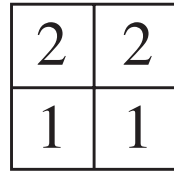
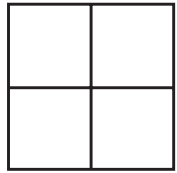

b) Top view      Ground plan      Front view      Side view

i)

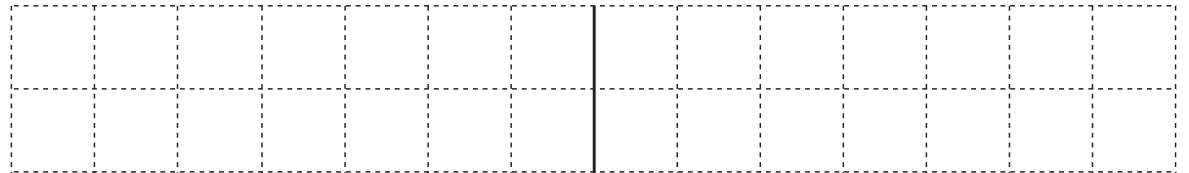
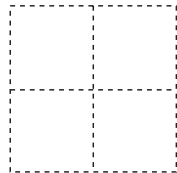
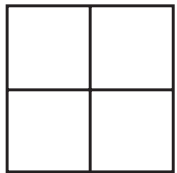

ii)

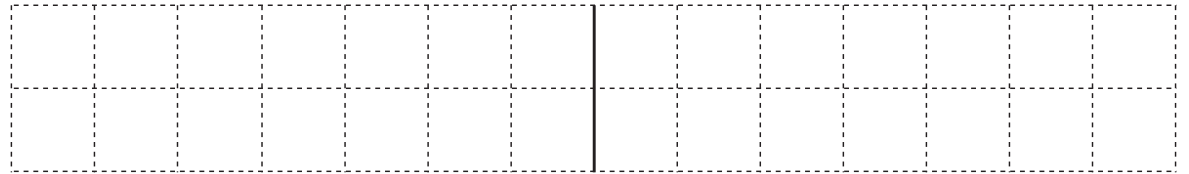
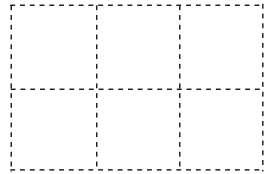
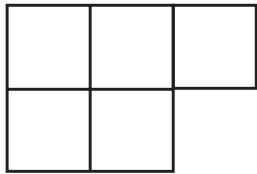

iii)

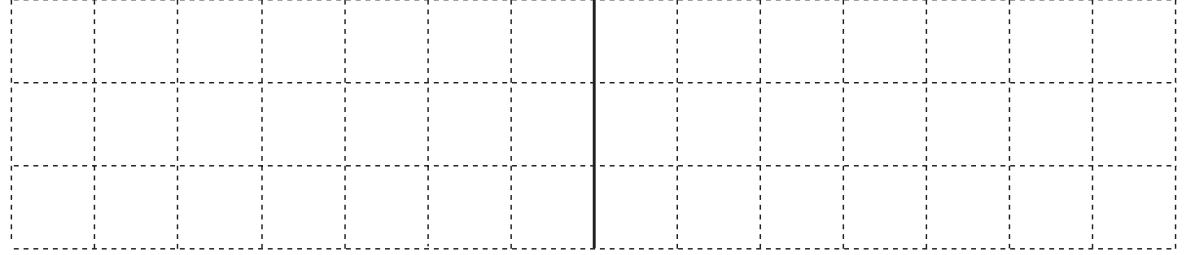
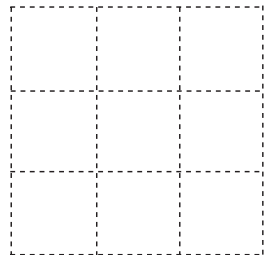
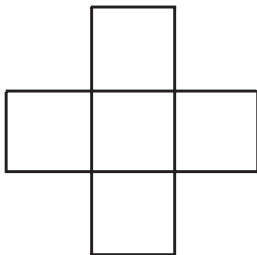

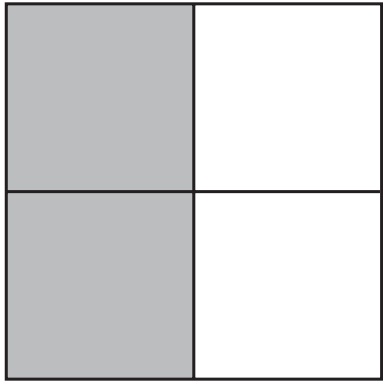

2 halves

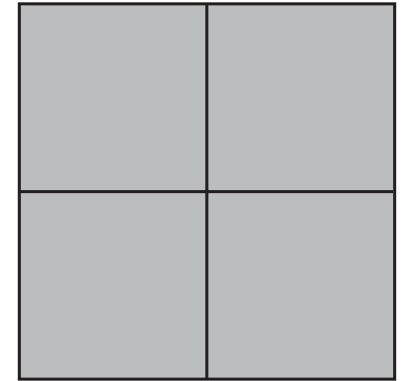

1 half

2 thirds

4 eighths

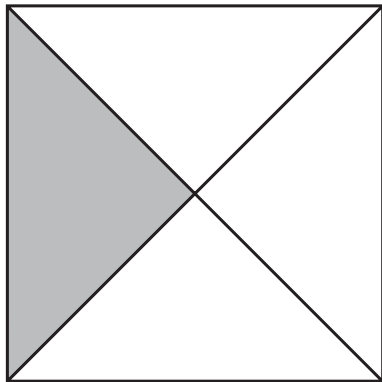

1 quarter

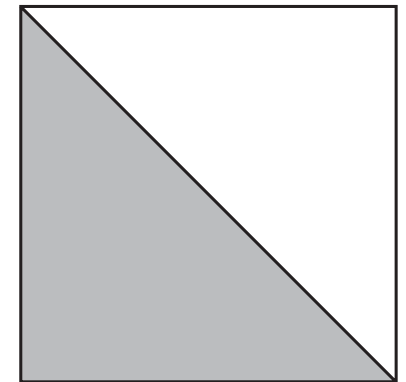
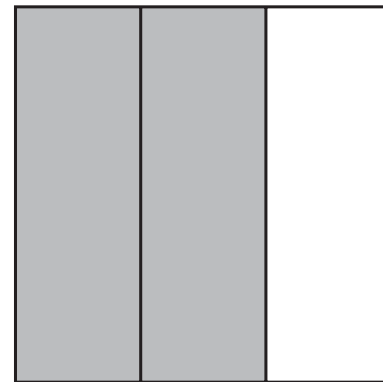

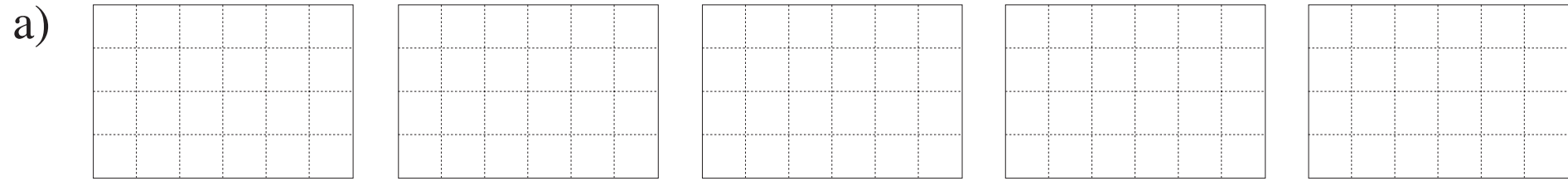

1 half

1 quarter

1 third

1 sixth

1 twelfth

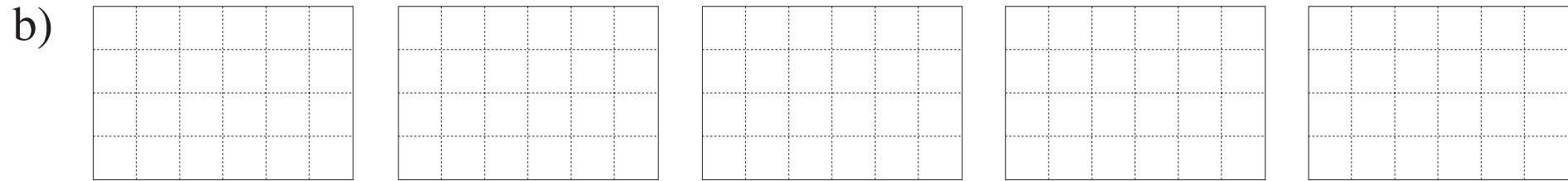

2 halves

2 quarters

2 thirds

2 sixths

2 twelfths

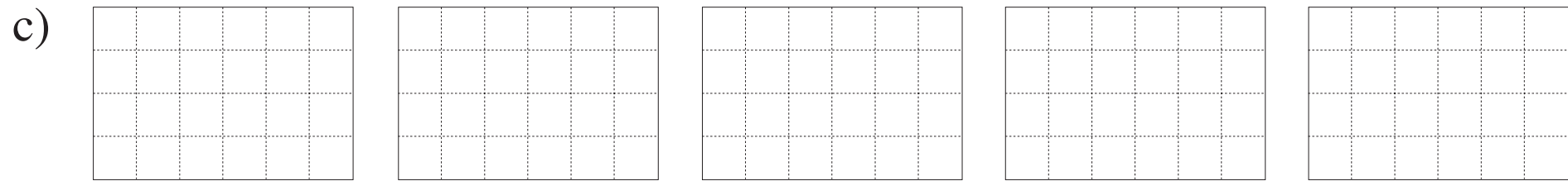

3 eighths

3 quarters

3 thirds

3 sixths

3 twelfths

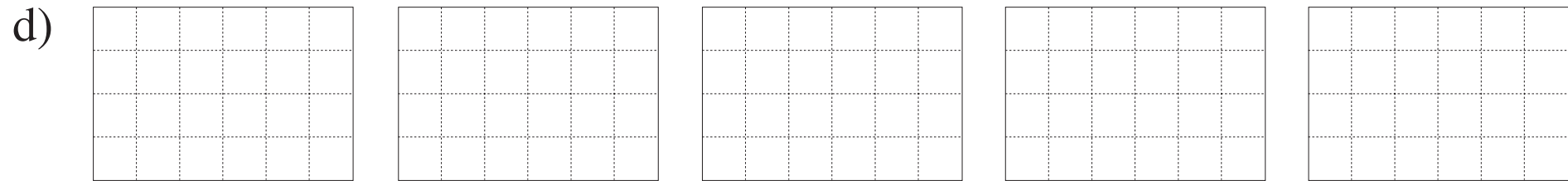

4 eighths

4 quarters

4 twelfths

6 sixths

6 twelfths

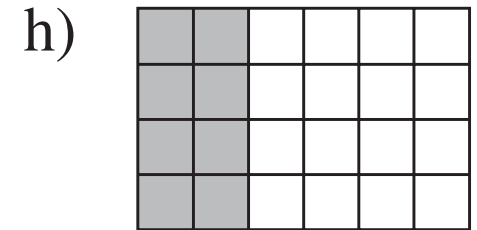
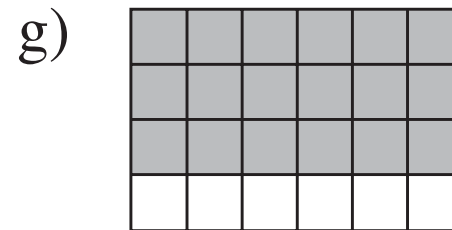
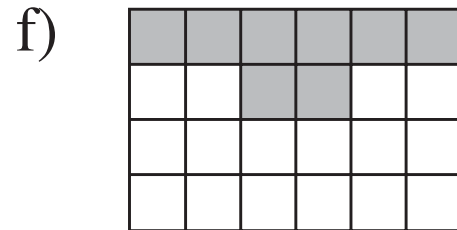
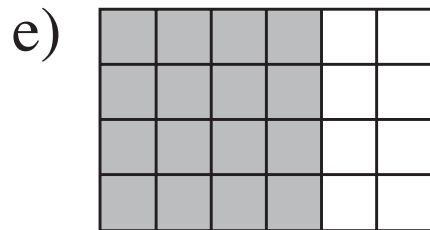
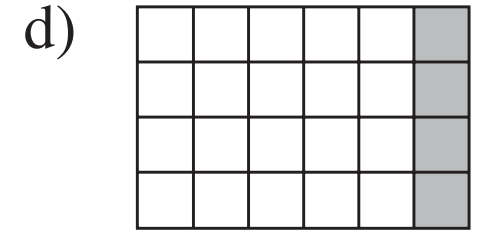
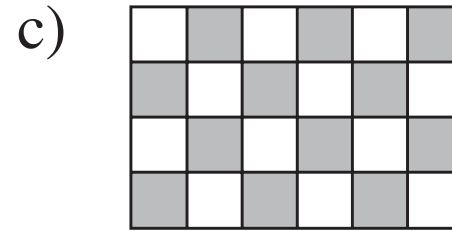
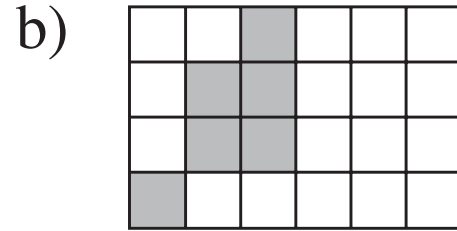
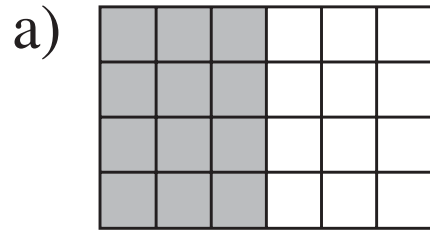

LP 97/5

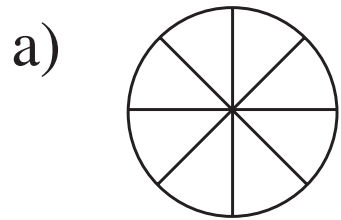

4 eighths

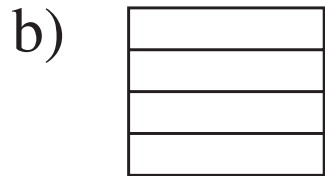

3 quarters

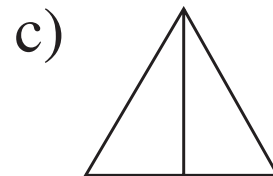

1 half

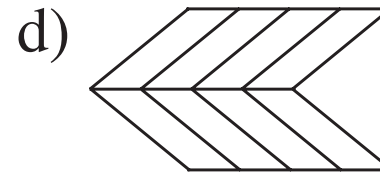

3 eighths

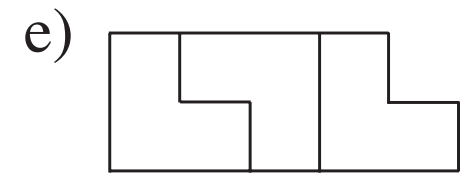

1 third

												1 unit
a)												.....
b)												.....
c)												.....
d)												.....
e)												.....
f)												.....
g)												.....





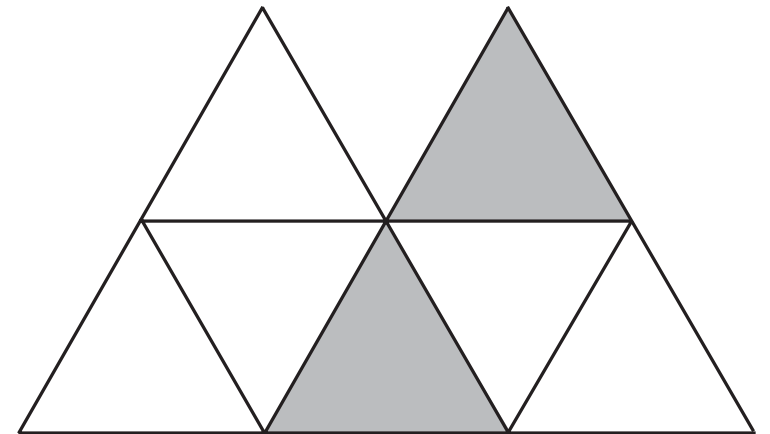
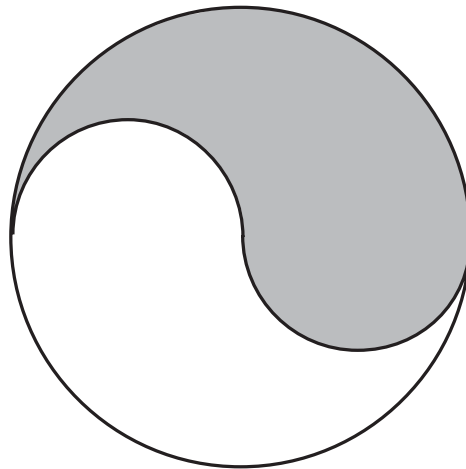
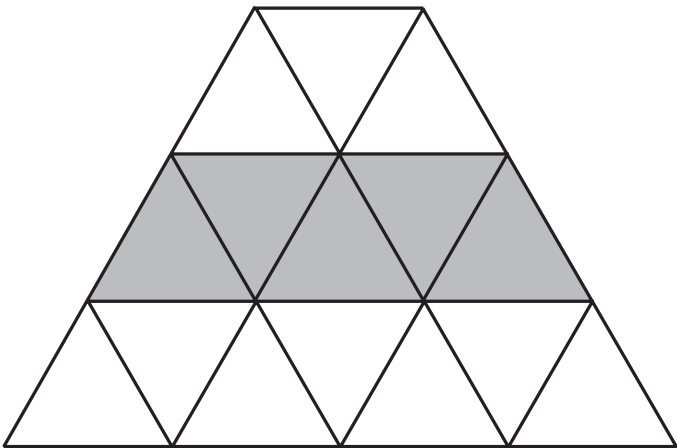
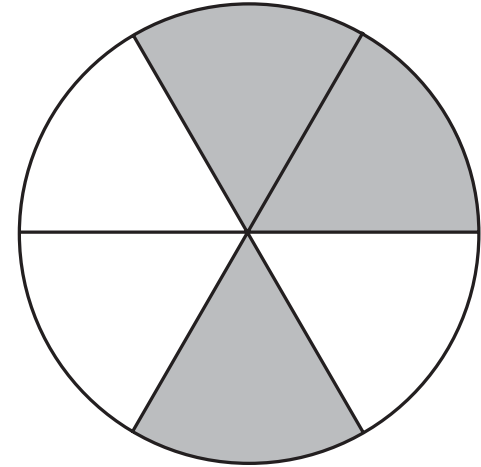
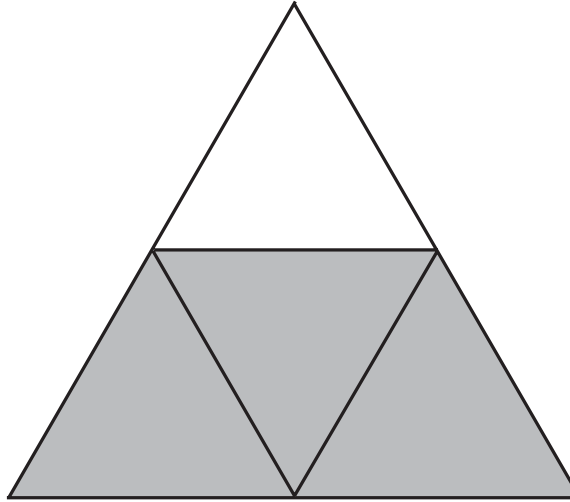
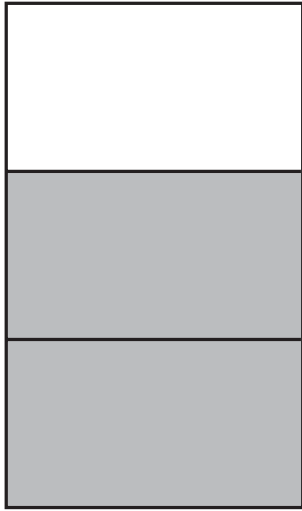

a)

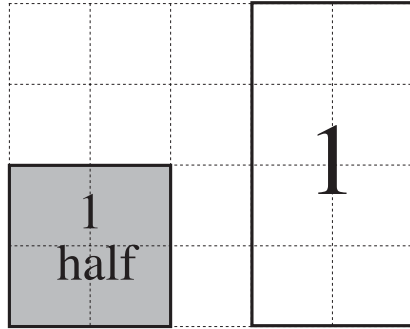

b)

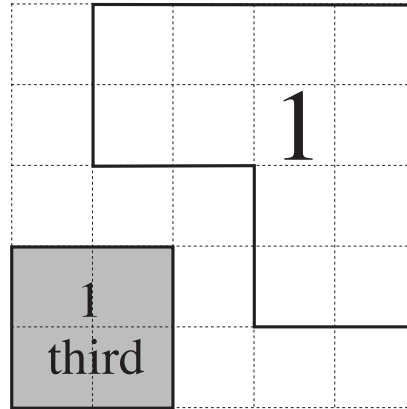

c)

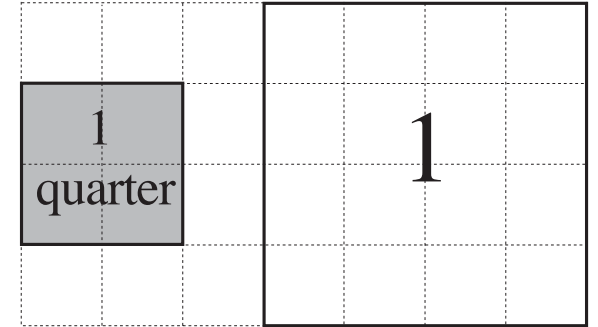

d)

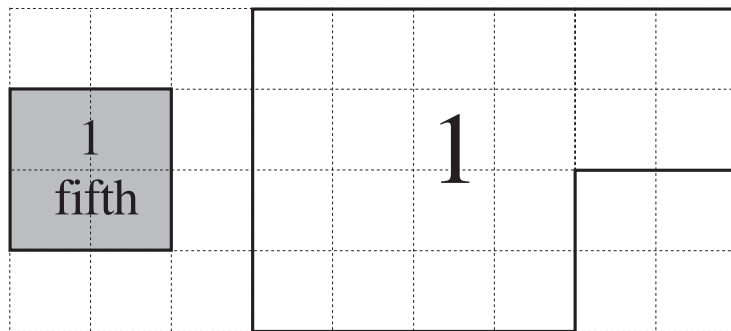

e)

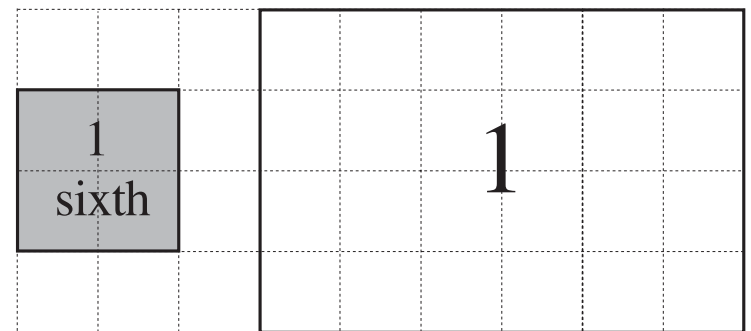

1 unit

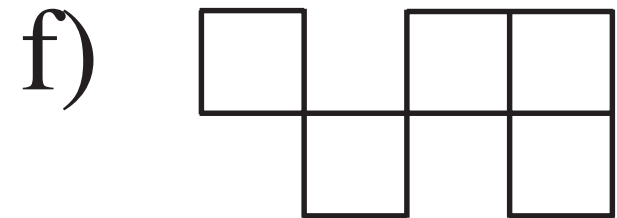
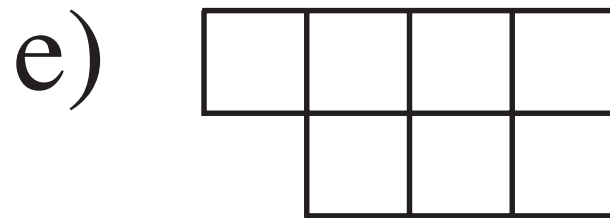
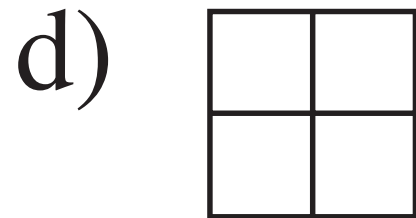
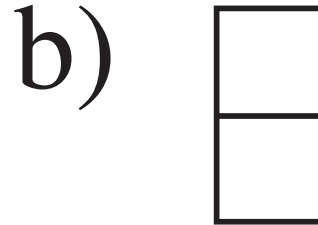
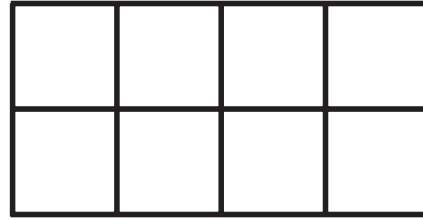

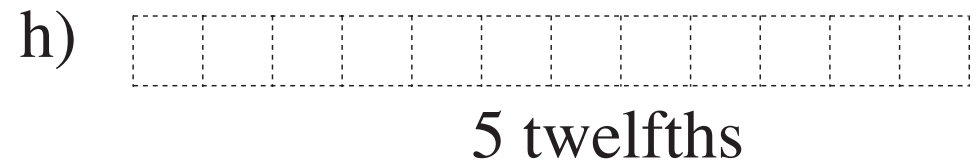
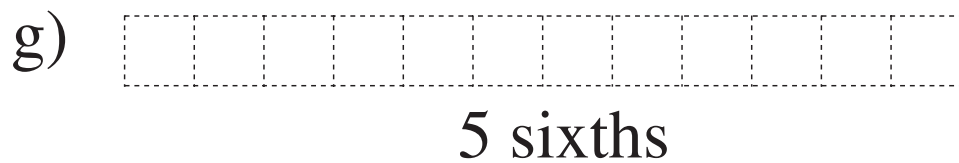
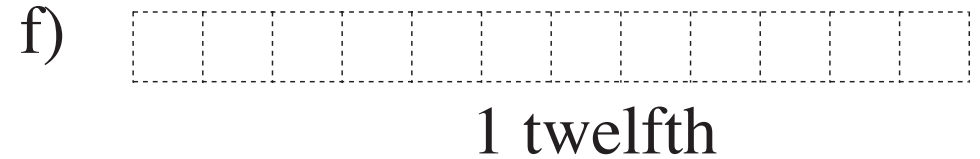
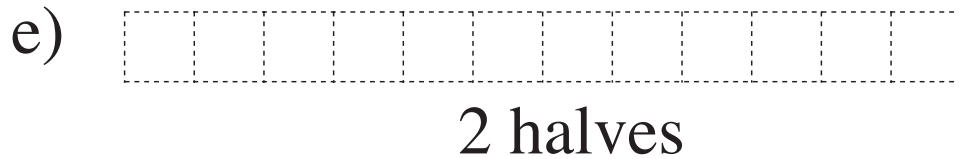
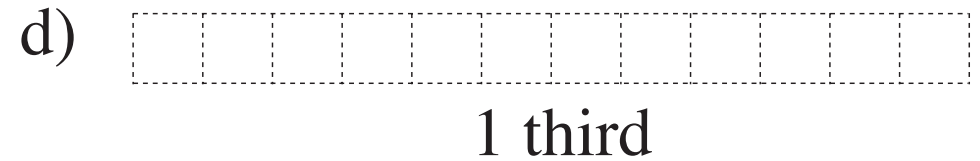
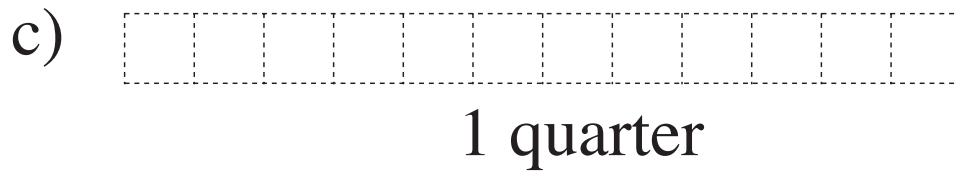
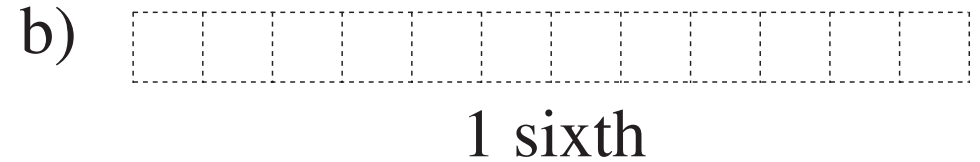
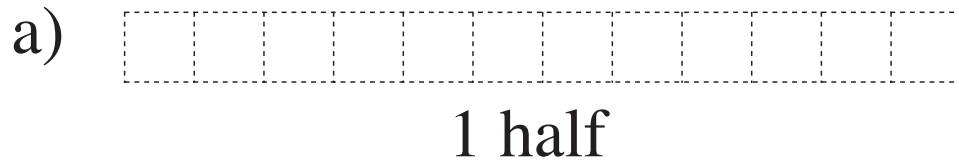

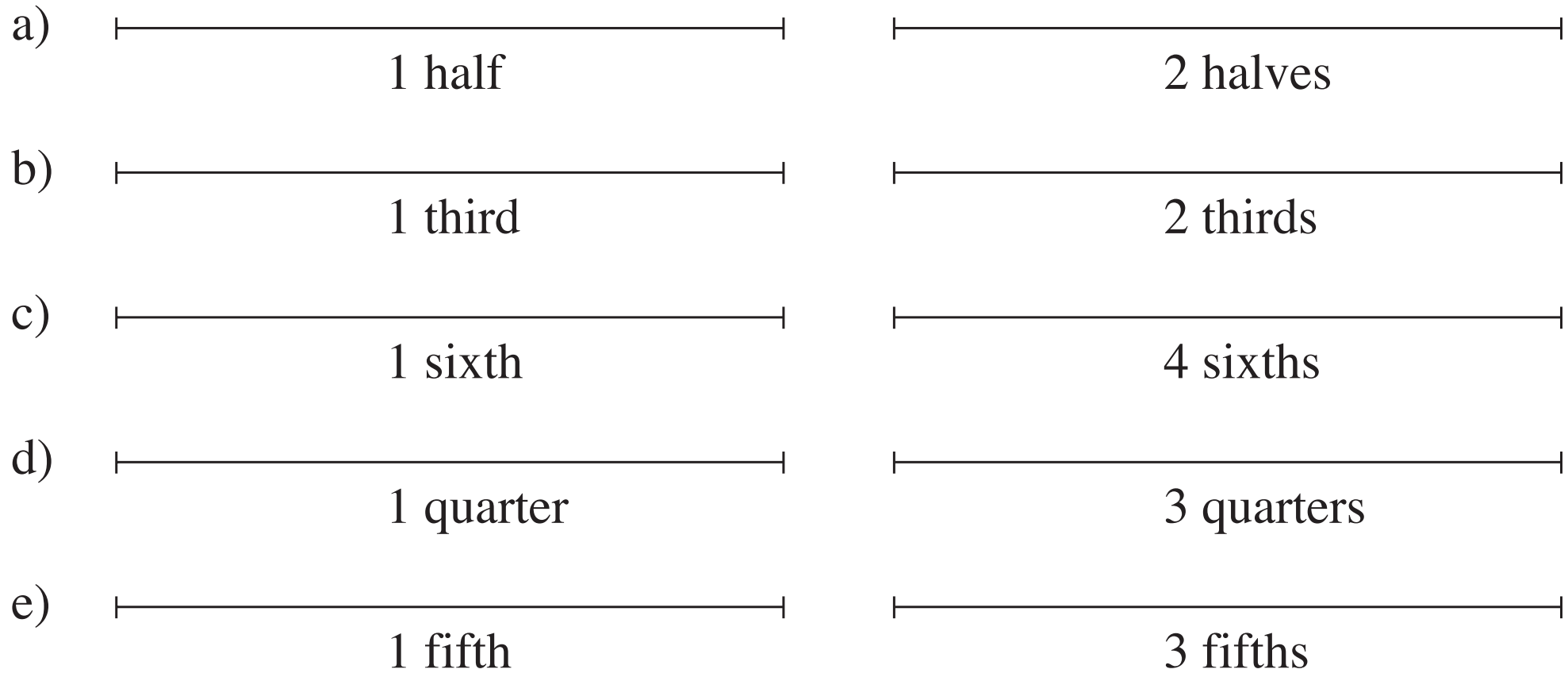

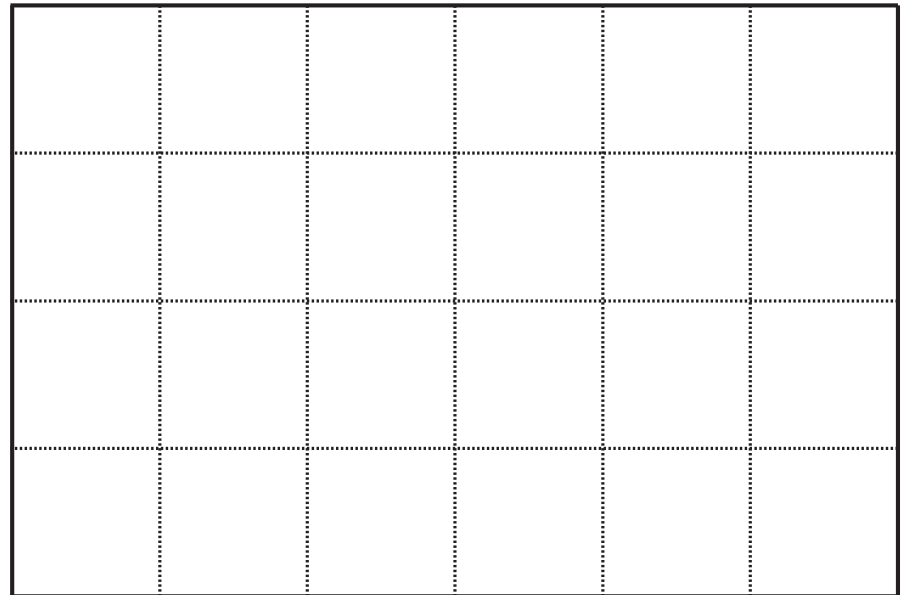
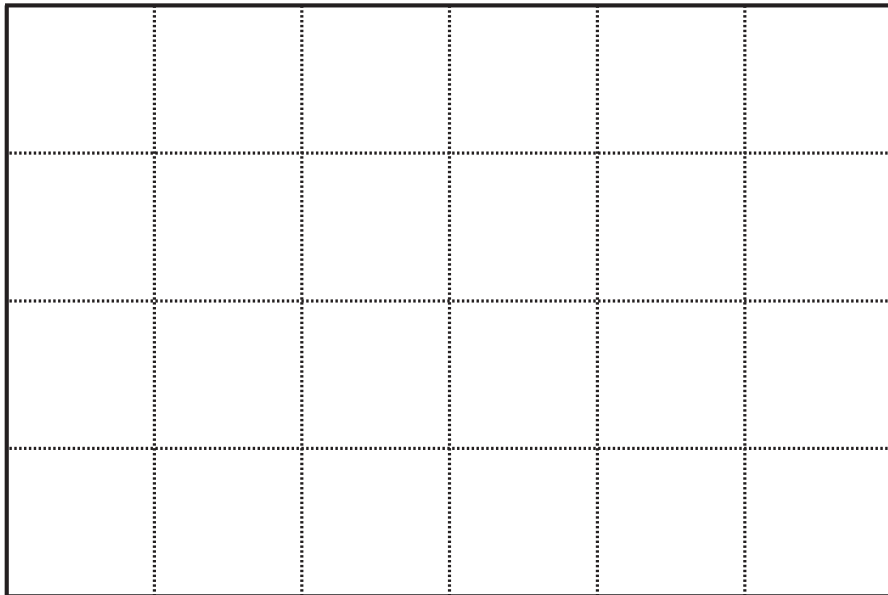
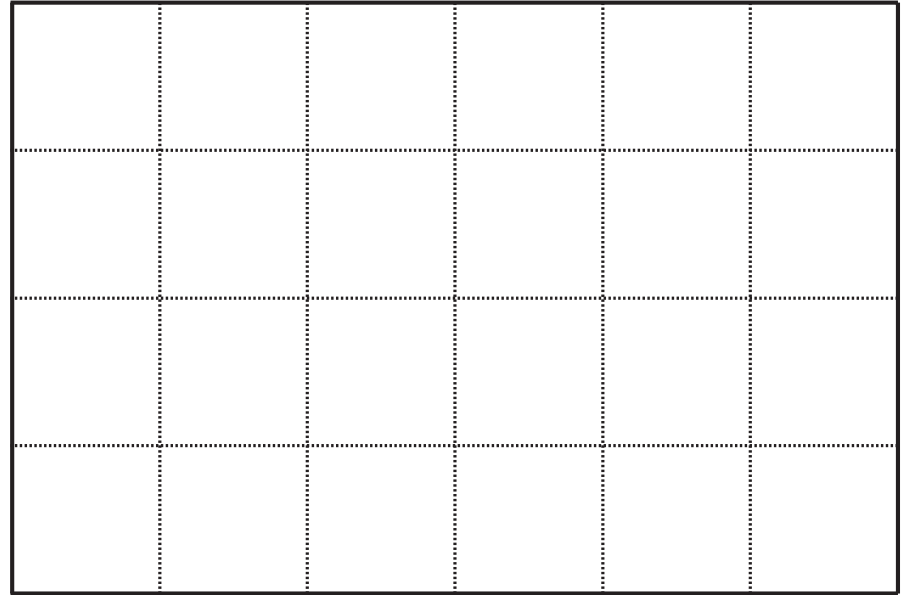
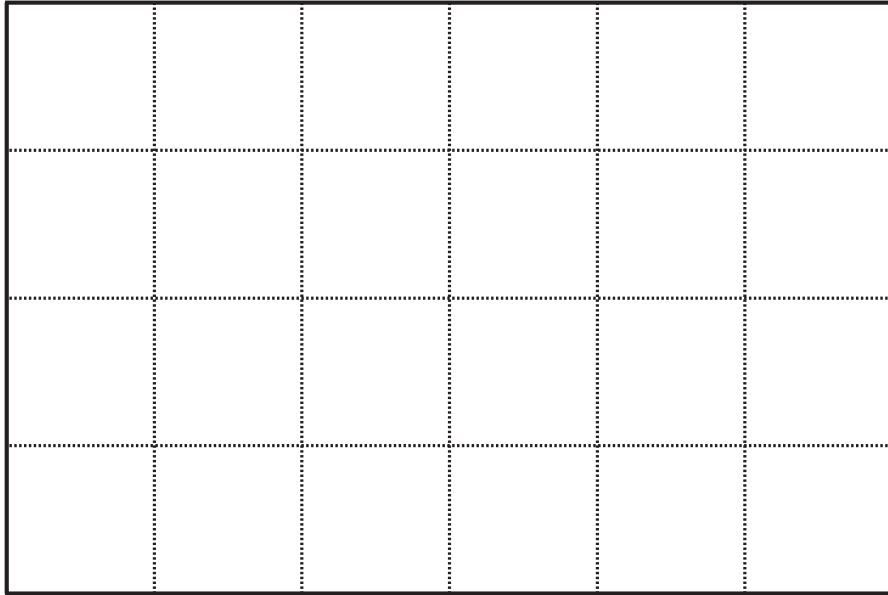

a)

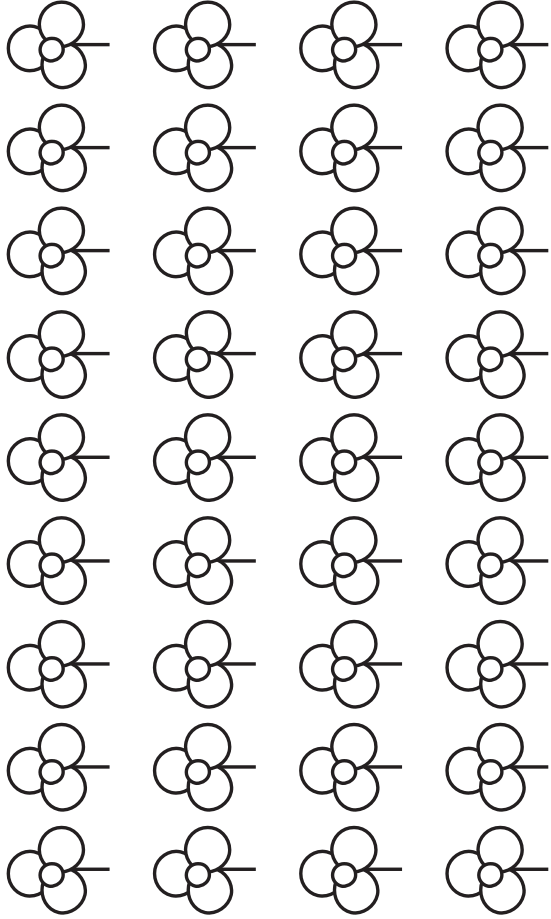

b)

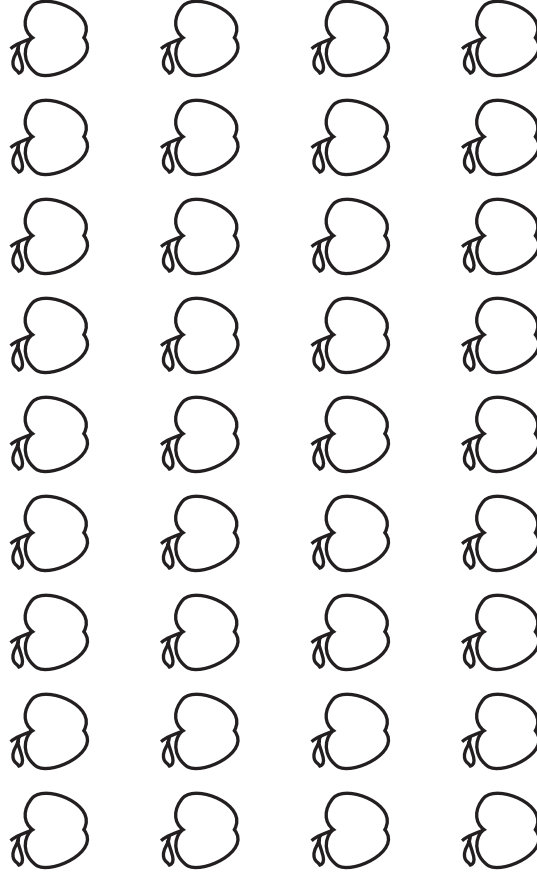

c)

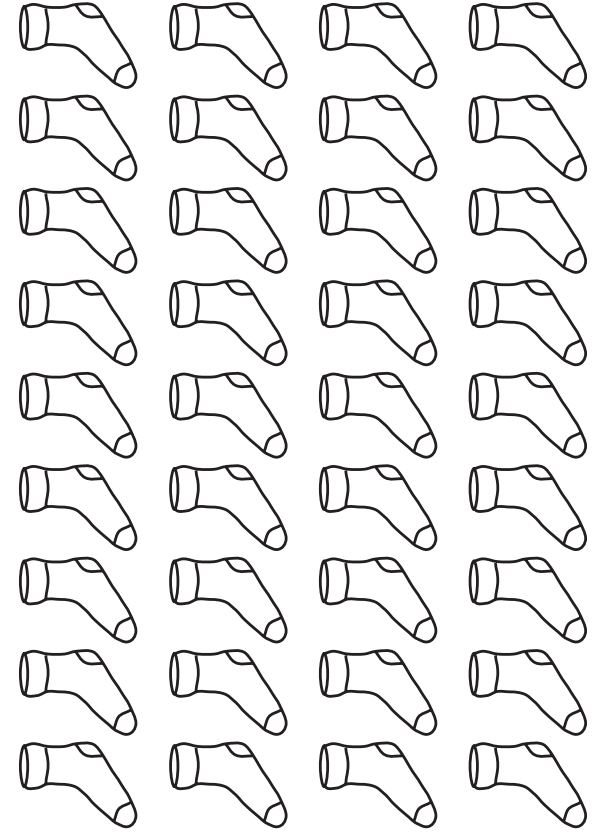

a)

<input type="text"/> half	<input type="text"/> halves	<input type="text"/> halves

b)

<input type="text"/> third	<input type="text"/> thirds	<input type="text"/> thirds	<input type="text"/> thirds

c)

<input type="text"/> quarter	<input type="text"/> quarters	<input type="text"/> quarters	<input type="text"/> quarters	<input type="text"/> quarters

d)

<input type="text"/> sixth	<input type="text"/> sixths	<input type="text"/> sixths	<input type="text"/> sixths	<input type="text"/> sixths

<input type="text"/> sixths

<input type="text"/> sixths



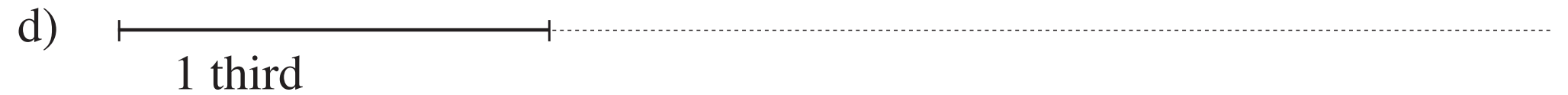
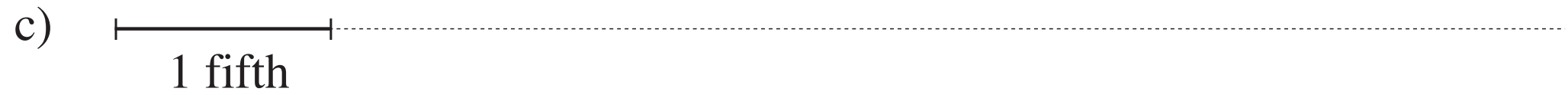
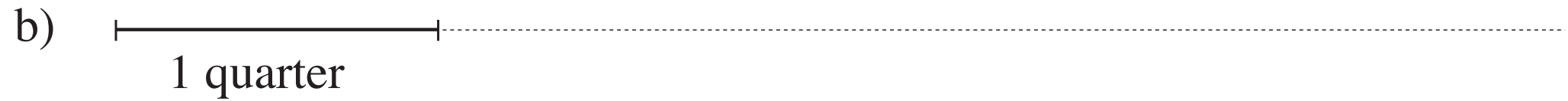
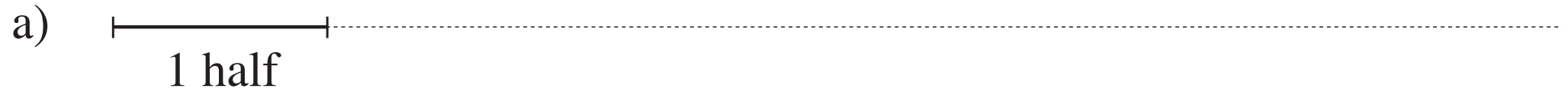

a)

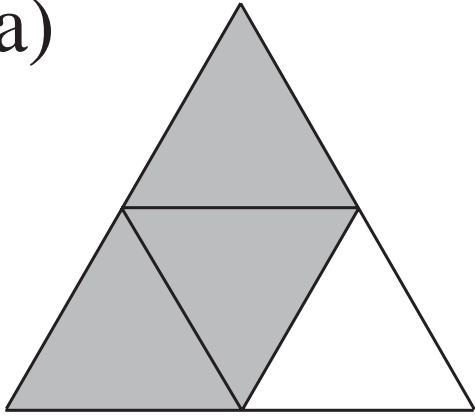

1 half

b)

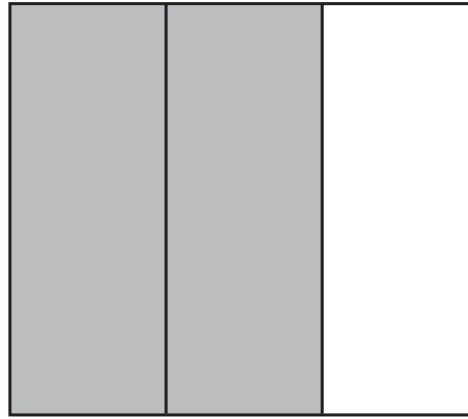

2 thirds

c)

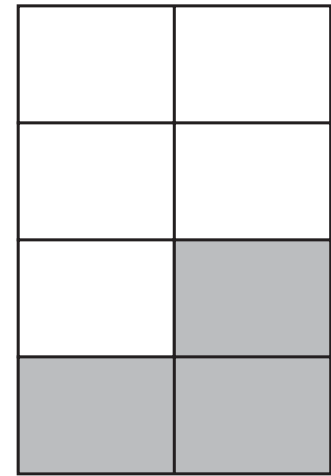

3 eighths

d)

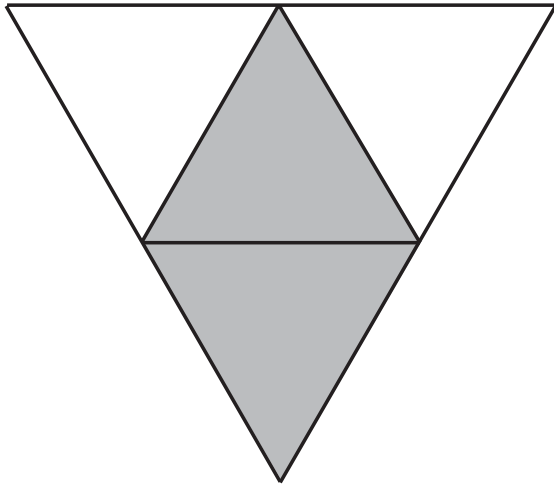

2 quarters

e)

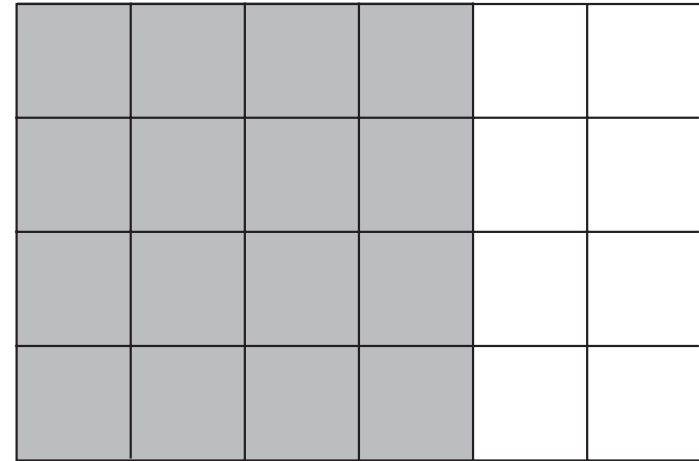

3 quarters

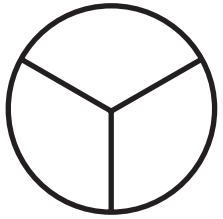

1

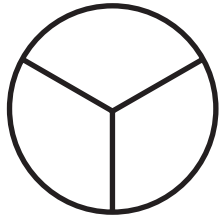

2

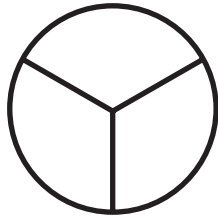

3

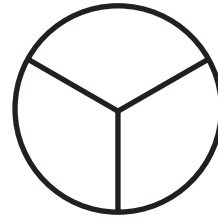

4

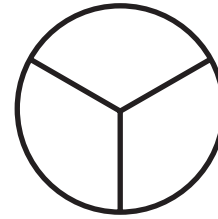

5

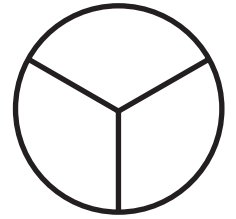

6

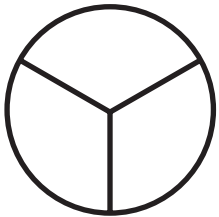

7

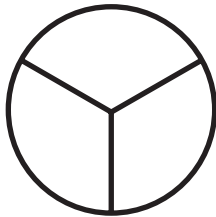

8

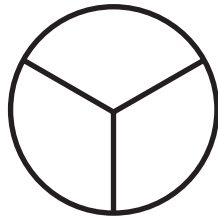

9

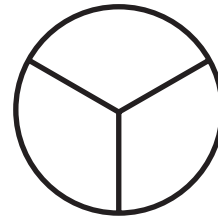

10

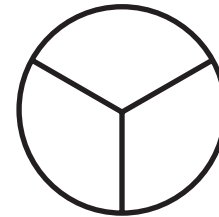

11

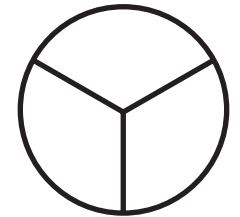

12

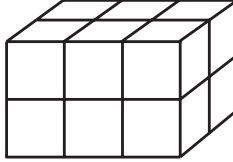
1 unit = 

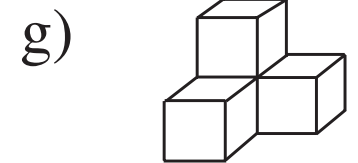
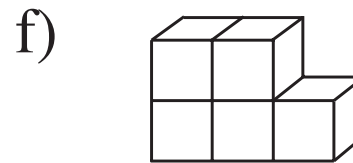
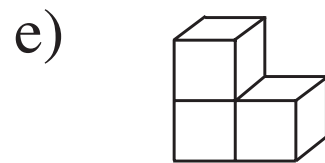
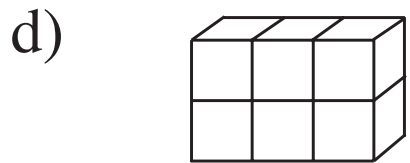
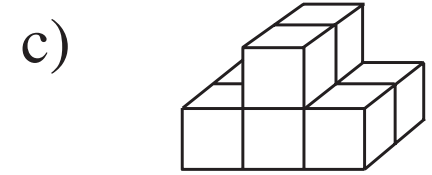
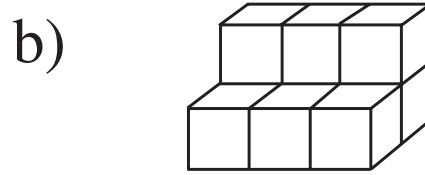
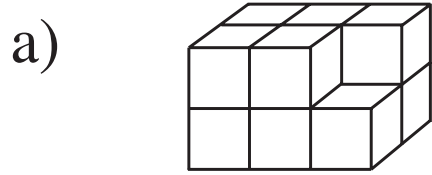

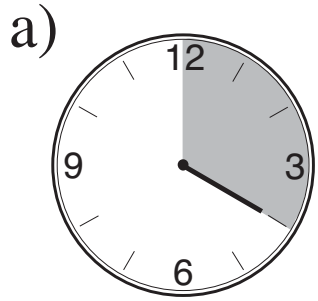

20 minutes

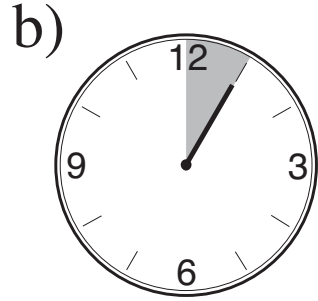

5 minutes

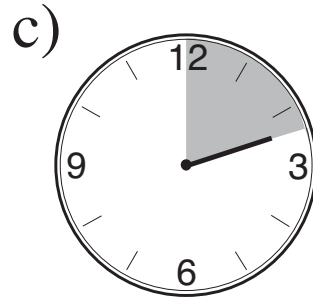

12 minutes

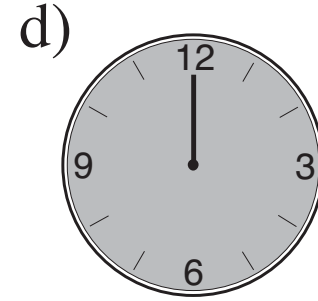

60 minutes

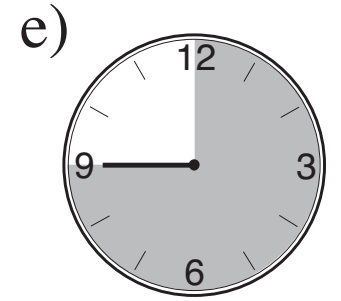

45 minutes

hour

hour

hour

hour

hour

a) half a metre =  cm

1 fifth of a metre =  cm

1 tenth of a metre =  cm

3 quarters of a metre =  cm

3 fifths of a metre =  cm

7 tenths of a metre =  cm

11 hundredths of a metre =  cm

b) half a kg =  g

1 quarter of a kg =  g

1 tenth of a kg =  g

3 quarters of a kg =  g

5 tenths of a kg =  g

2 fifths of a kg =  g

9 hundredths of a kg =  g

a)  $349 + 572 < 727 \square 199$

C:

	3	4	9
+	5	7	2

b)  $942 - 443 > 849 \square 367$

C:



0, 4, 13, 30, 72, 95, 100, 321, 679, 1000, 1006, 1027, 2000

a)

Even	Odd

b)

Whole tens	Not whole tens

c)

3-digit	Not 3-digit

d)

Whole hundreds	Not whole hundreds



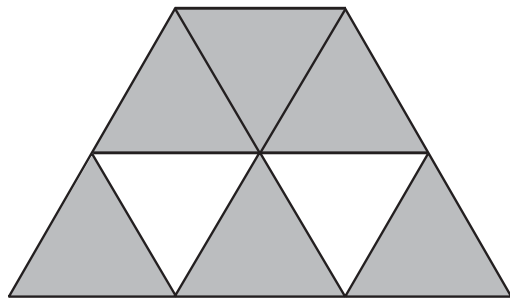
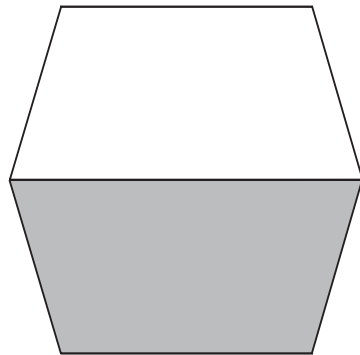
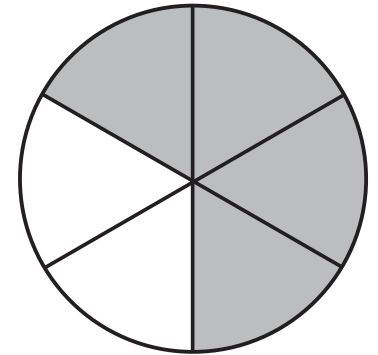
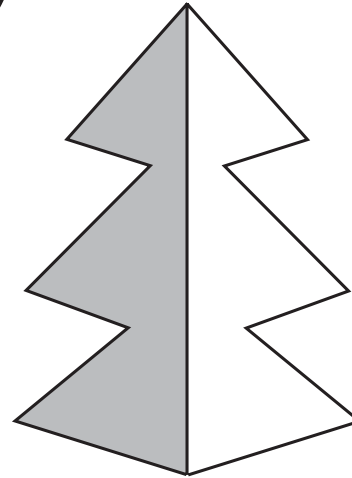
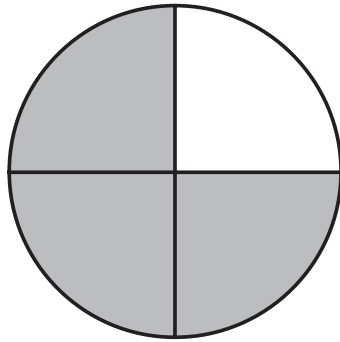
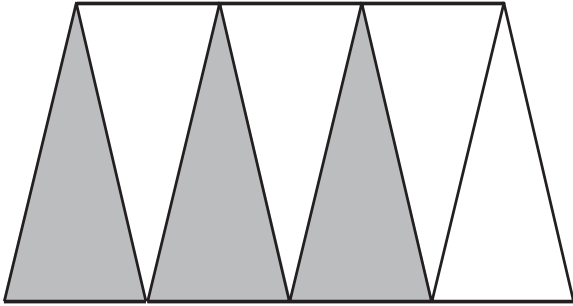

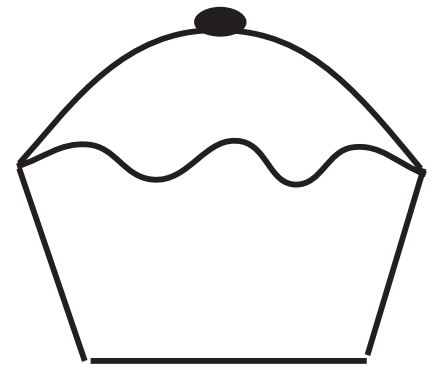
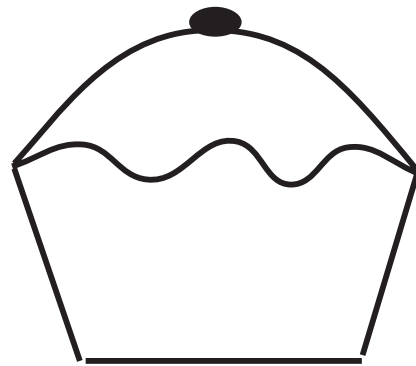
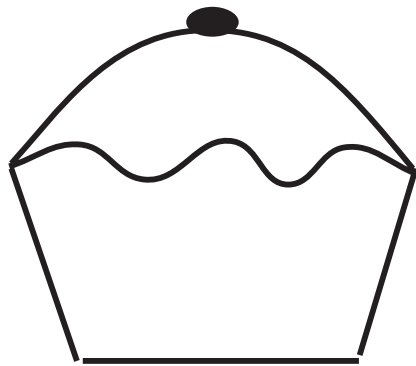
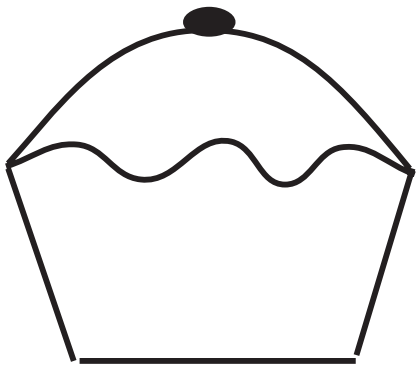
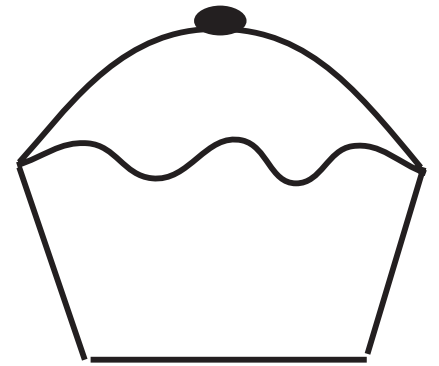
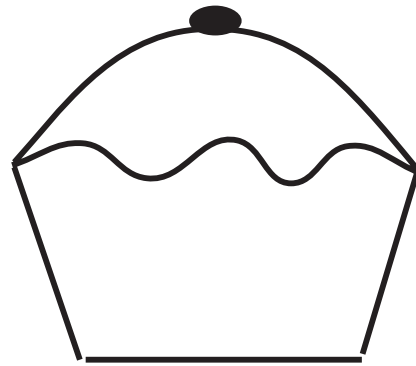
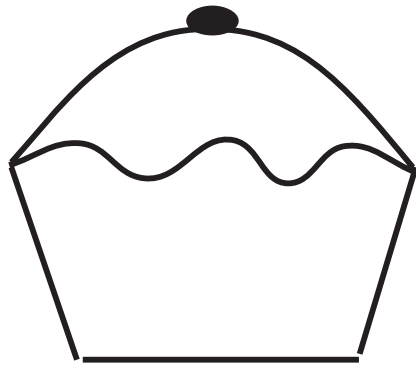
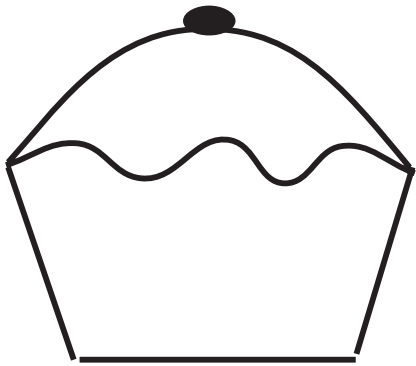
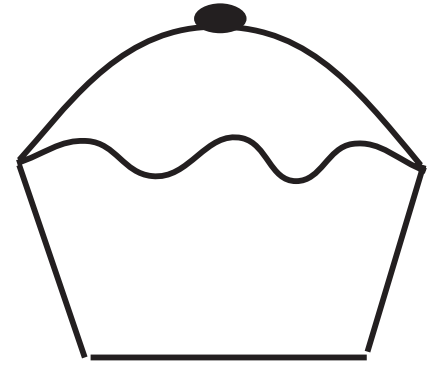
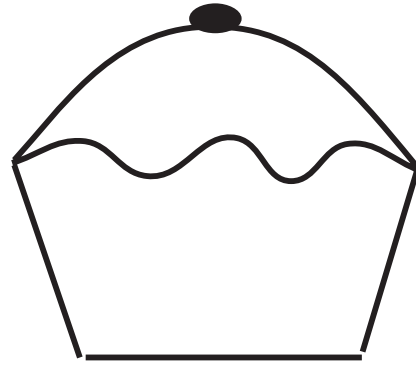
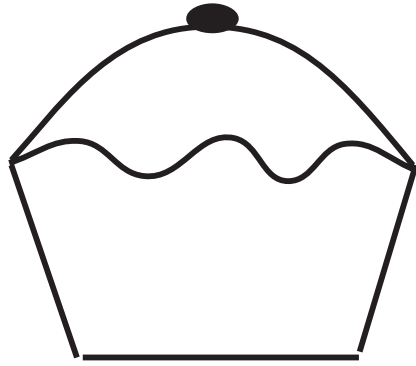
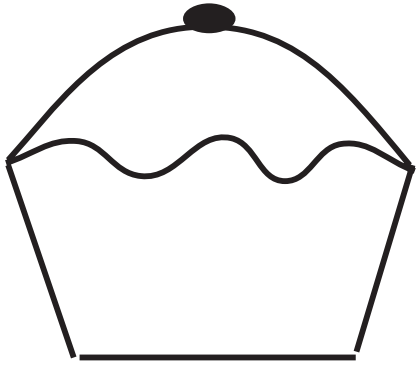

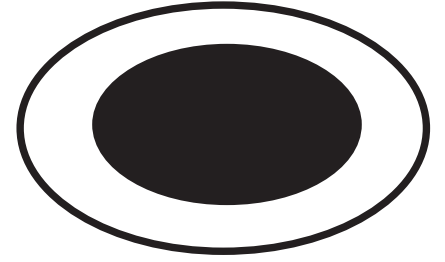
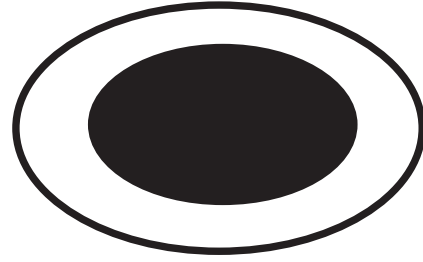
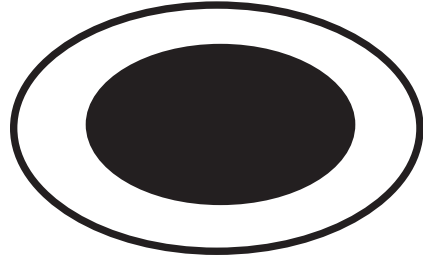
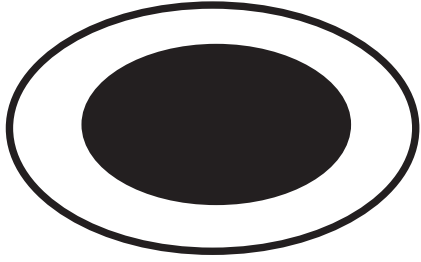
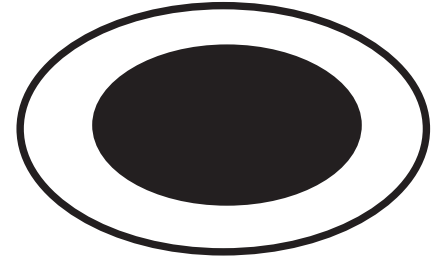
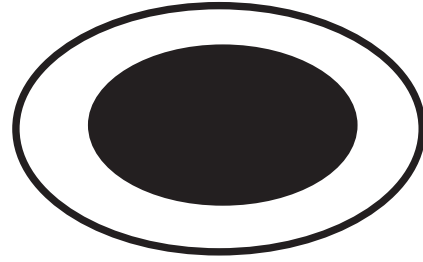
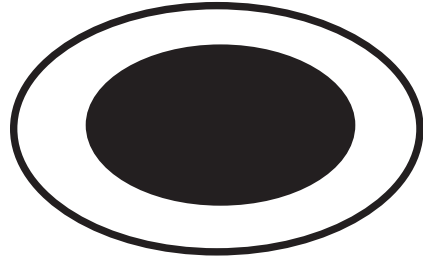
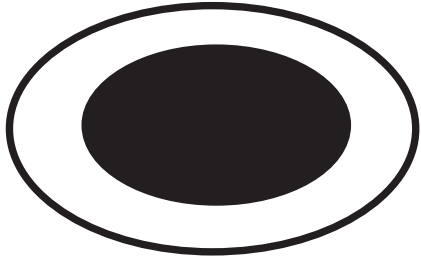
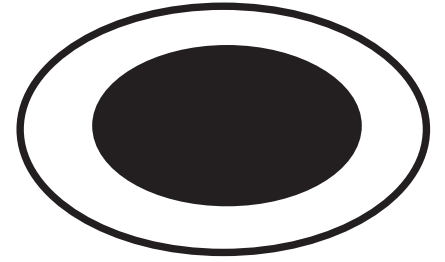
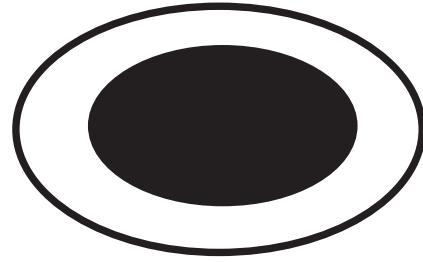
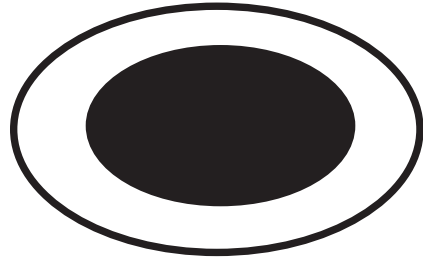
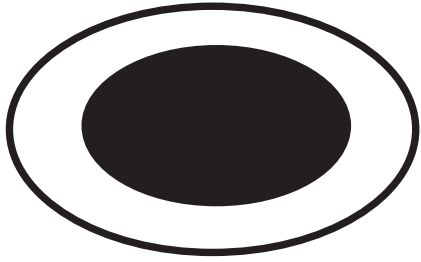
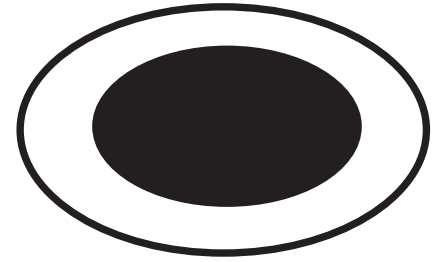
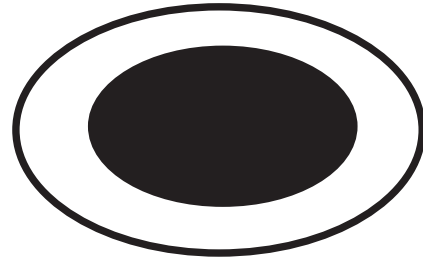
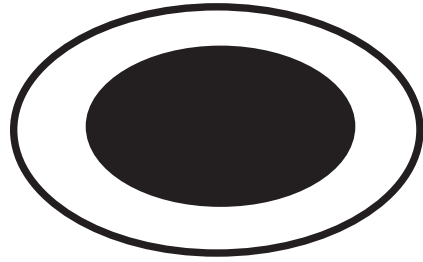
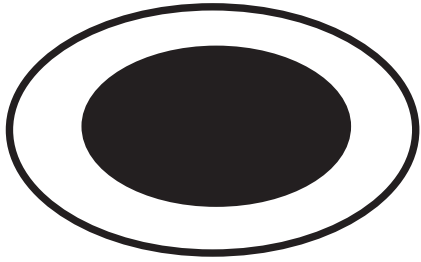

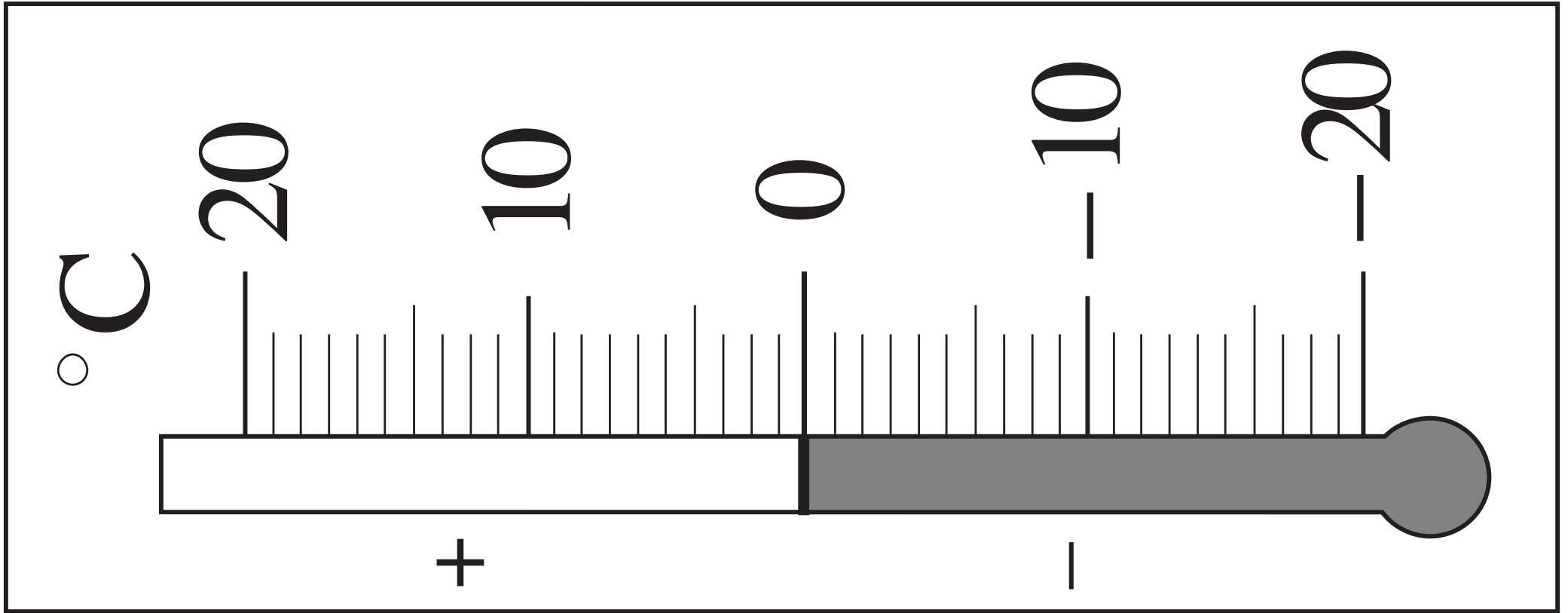

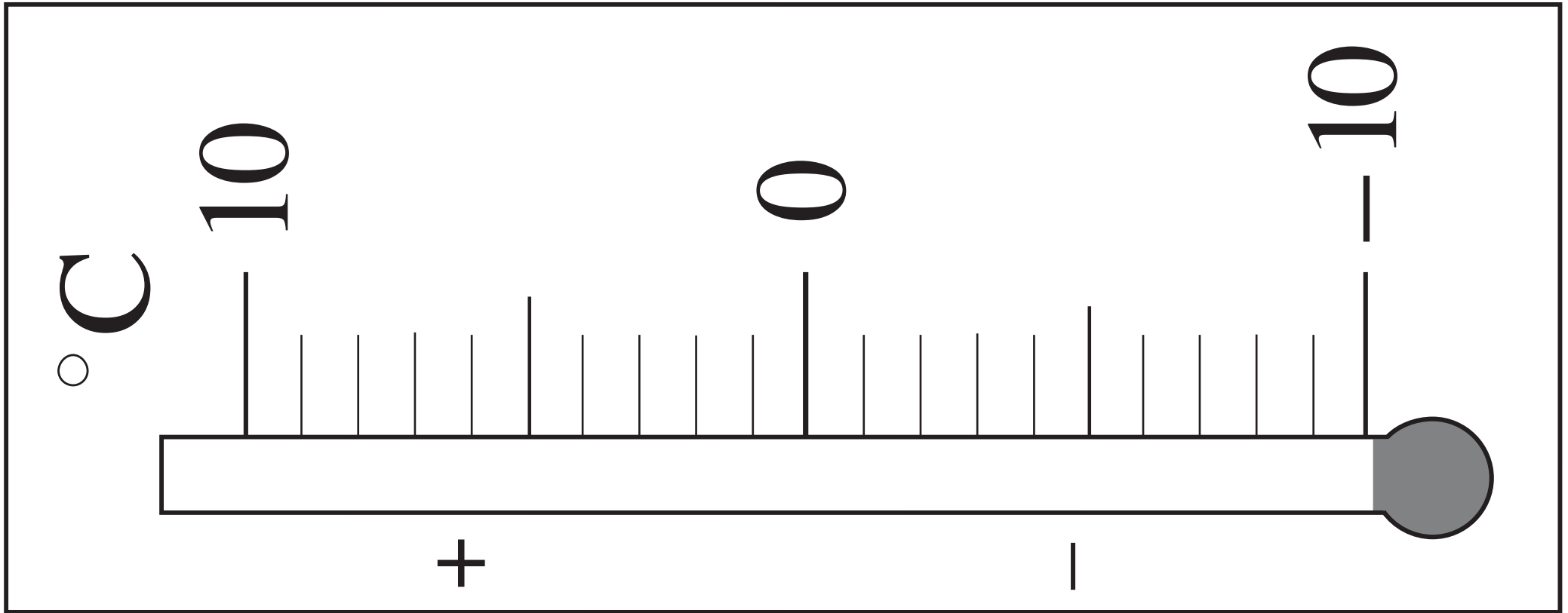

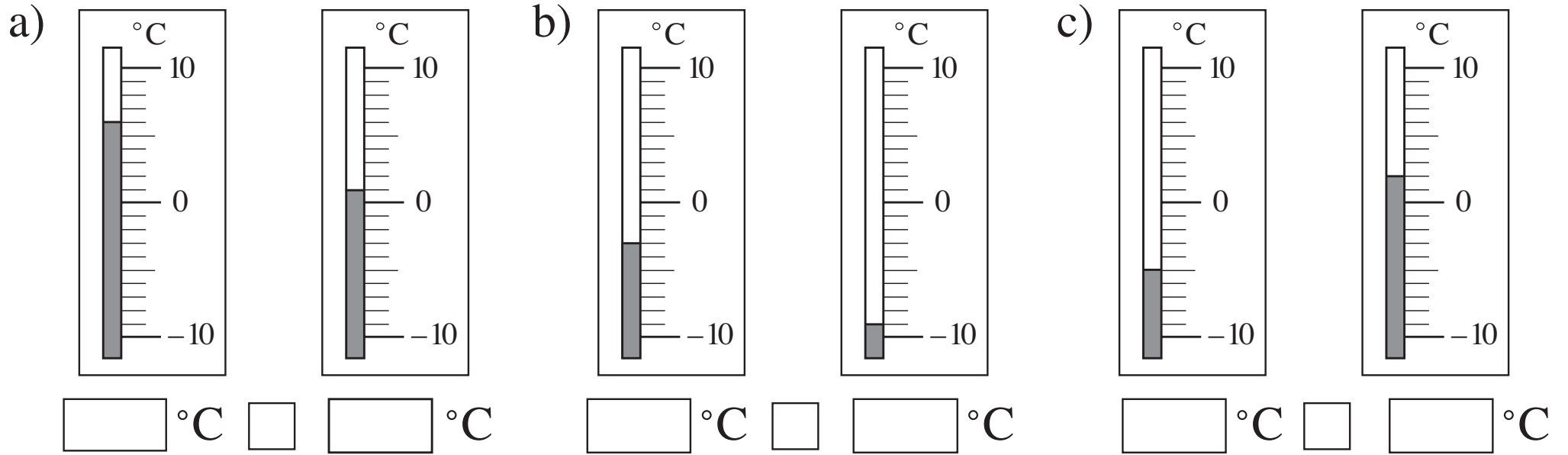

LP 103/3

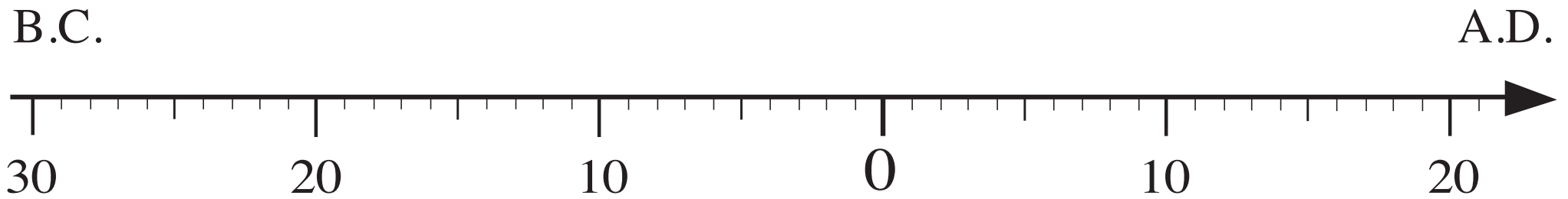

LP 103/5

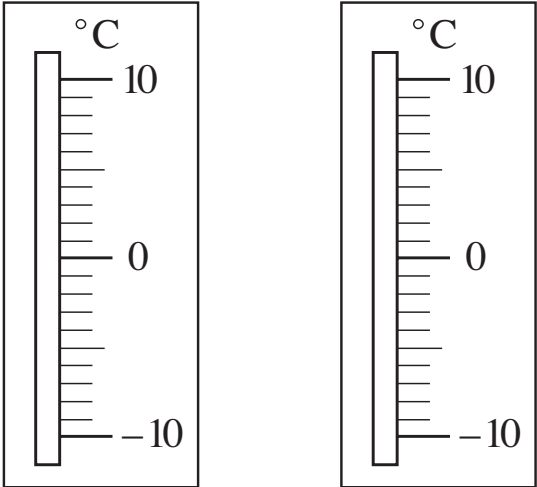
a)     
 $5^{\circ}\text{C}$    $-5^{\circ}\text{C}$   
  $^{\circ}\text{C}$

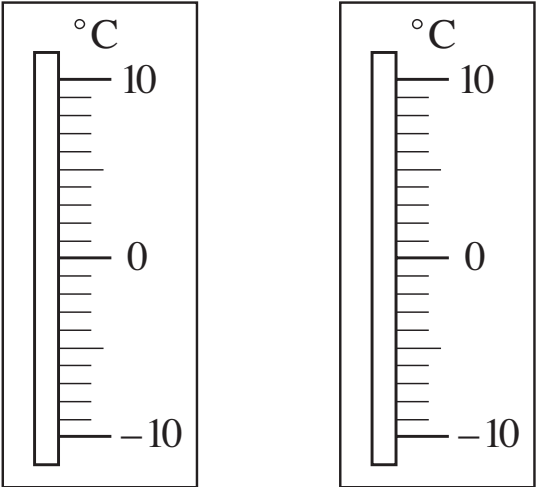
b)     
 $-9^{\circ}\text{C}$    $0^{\circ}\text{C}$   
  $^{\circ}\text{C}$

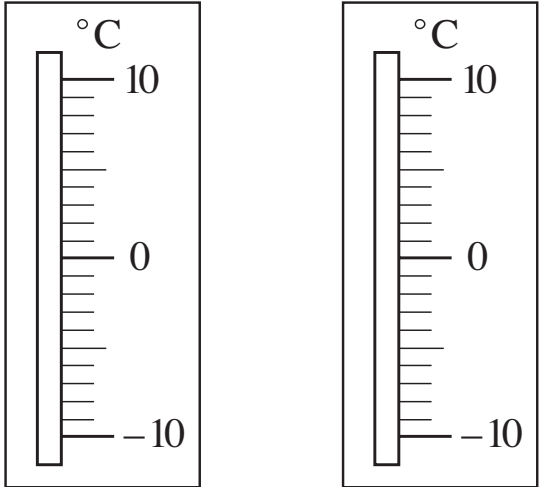
c)     
 $-1^{\circ}\text{C}$    $-10^{\circ}\text{C}$   
  $^{\circ}\text{C}$

LP 103/6

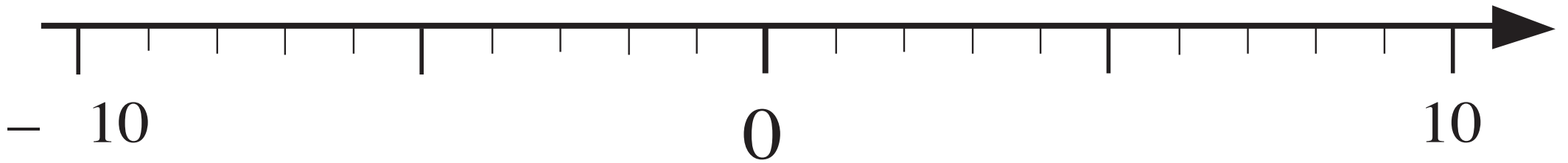

a) Ann

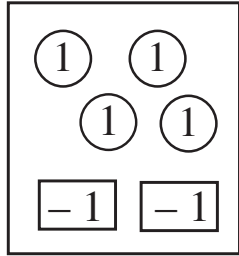

Paul

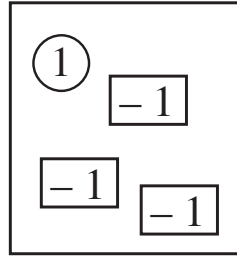

b) Ben

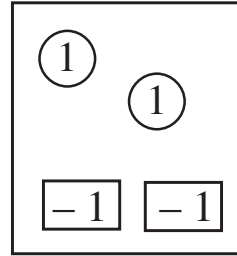

Rose

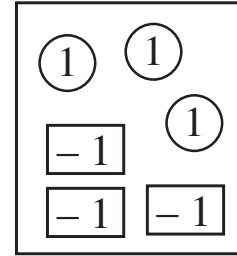

c) Colin

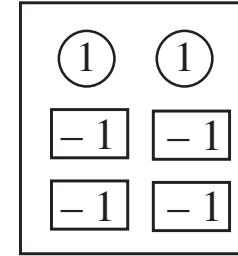

Sonia

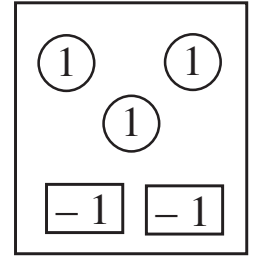



LP 104/8

 a) Alice's balance is  $-\pounds 6$ :  $(1) (1) [-1] [-1] [-1] [-1] [-1] [-1]$  .....

 b) Barry's balance is  $\pounds 3$ :  $(1) (1) (1) [-1] [-1]$  .....

 c) Carol's balance is  $\pounds 0$ :  $(1) (1) (1) (1) [-1] [-1] [-1] [-1]$  .....

 d) Dan's balance is  $-\pounds 4$ :  $(1) (1) (1)$  .....

 e) Eve's balance is  $\pounds 5$ :  $(1) (1) (1) (1) (1) (1)$  .....



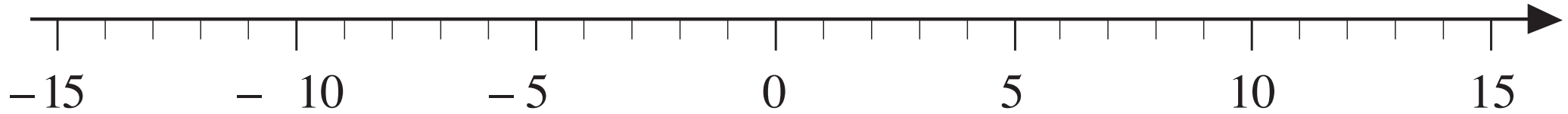
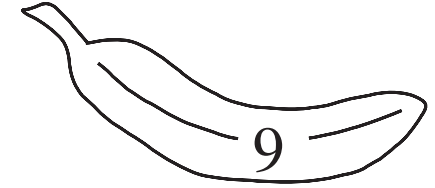
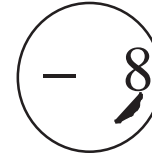
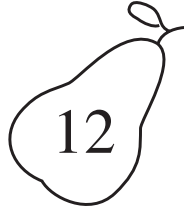
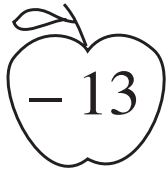

LP 104/3

Time (hours)	7	8	9	10	11	12	13	14	15	16	17	18	19
Temperature (°C)	-9	-10	-6	-2	0	3	6	8	9	7	4	-1	-3

LP 104/8a

# Lisa

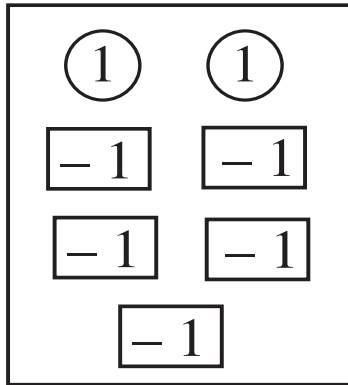

# Charlie

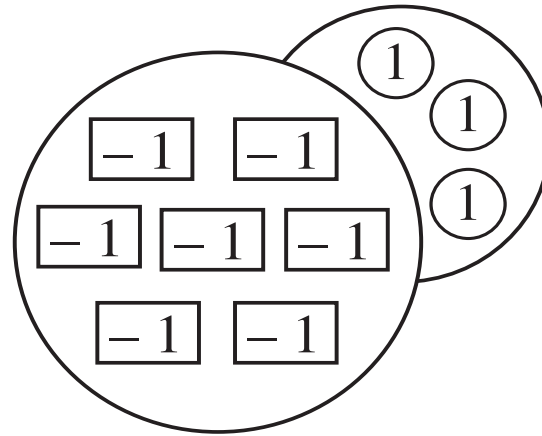

# Billy

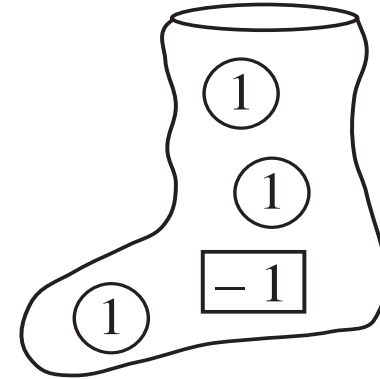

# Clare

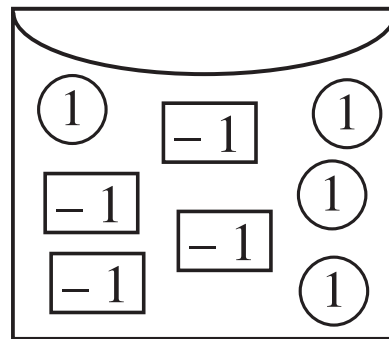

# Diane

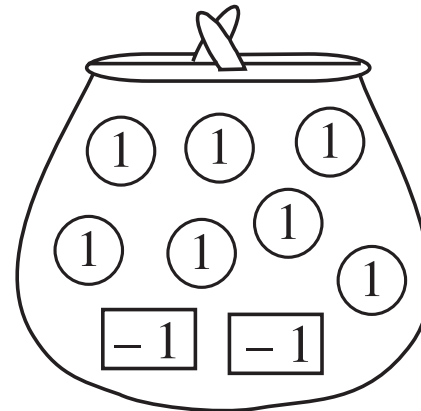

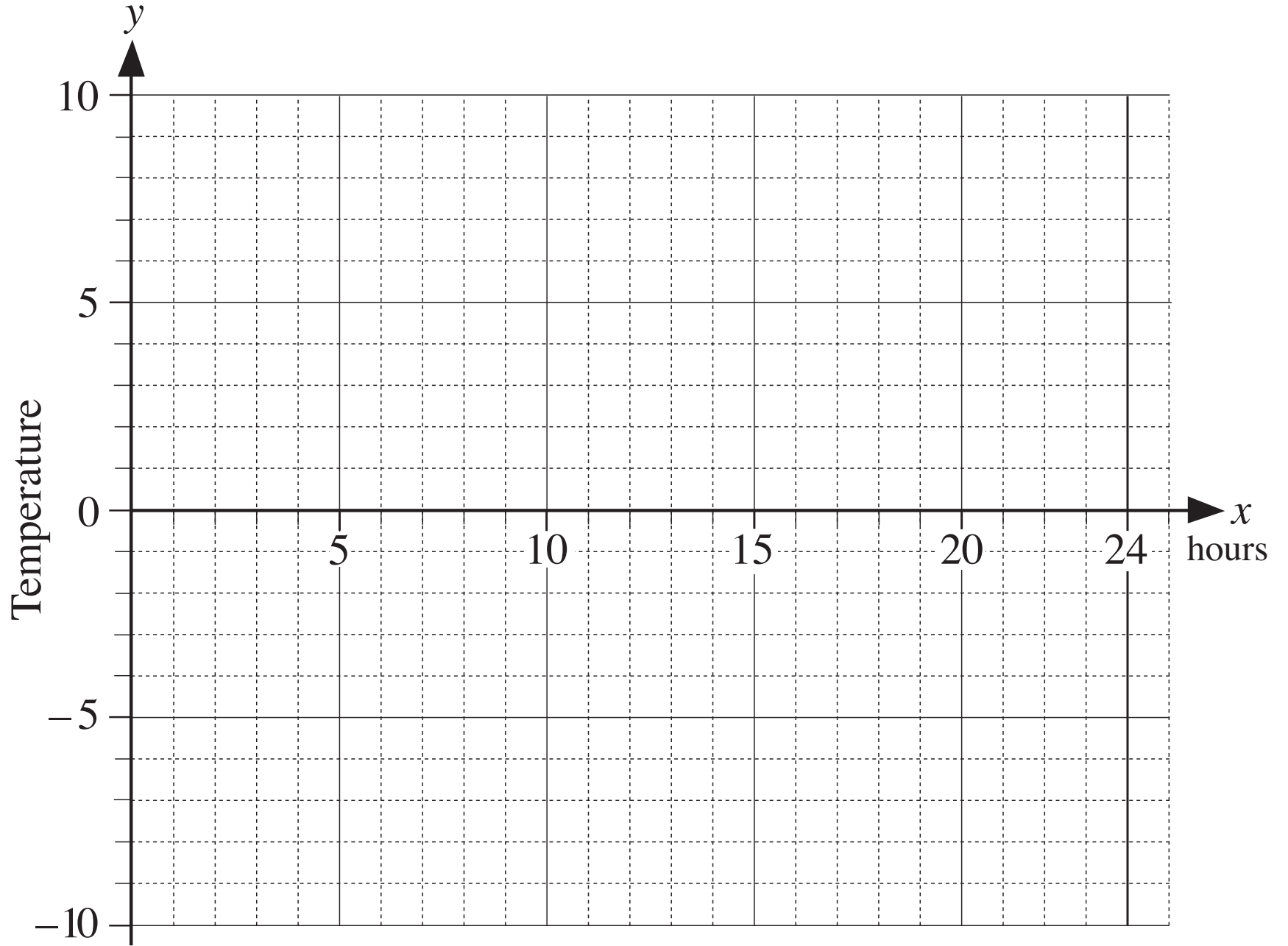
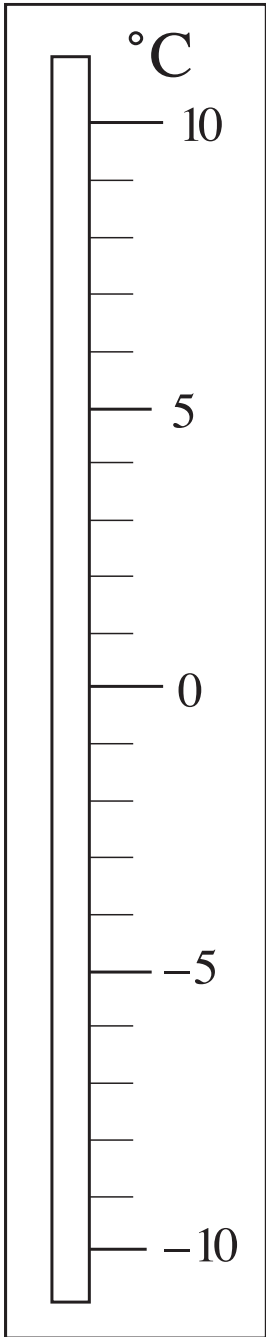

$$\text{a)} \quad -3 < -9 \\ 6$$

$$\text{b)} \quad -15 < -1 \\ 4$$

$$\text{c)} \quad -8 < -2 \\ 10$$

$$\text{d)} \quad -5 < 3 \\ 2$$

$$\text{e)} \quad -2 > 1 \\ 1$$

$$\text{f)} \quad -20 < 10 \\ 30$$

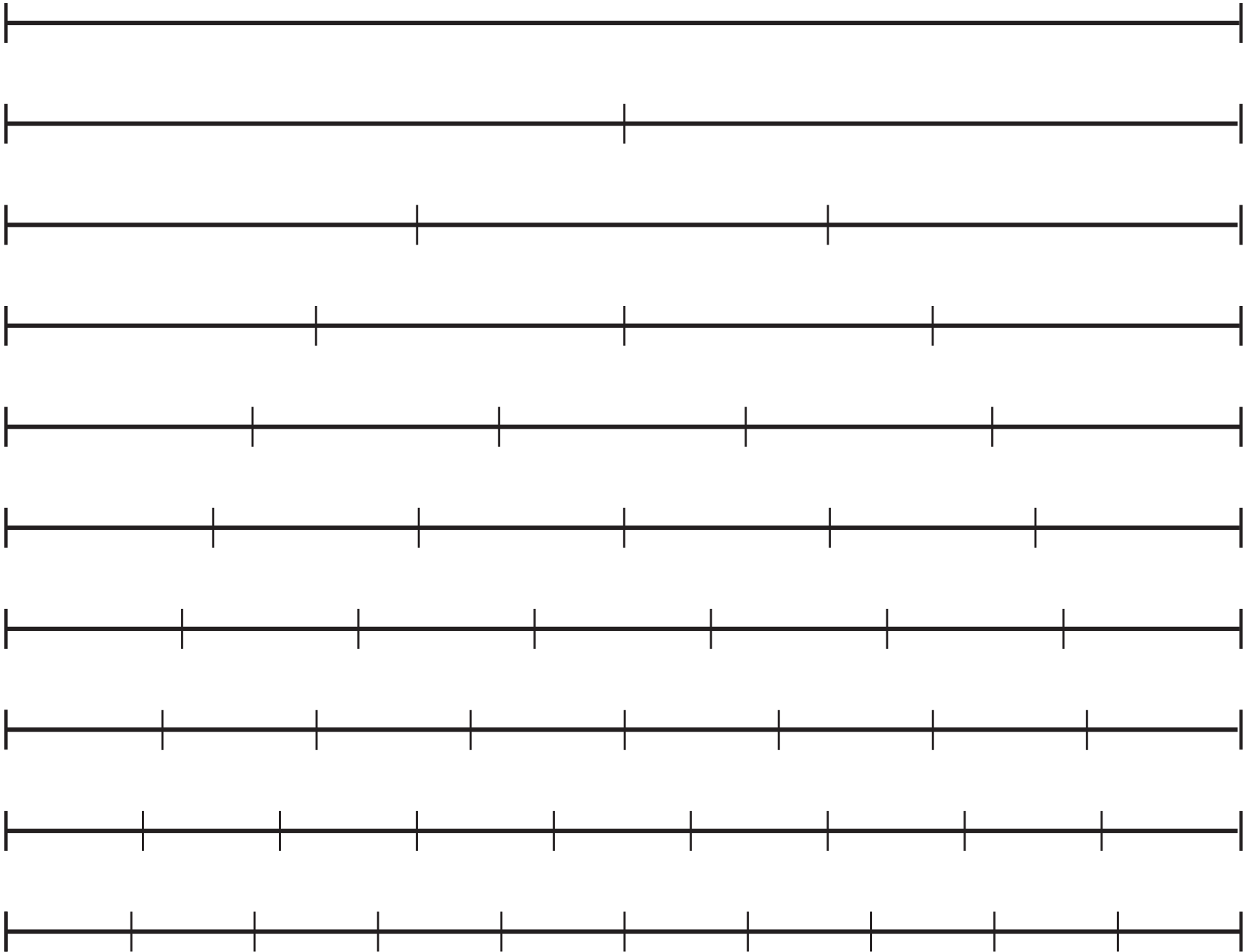

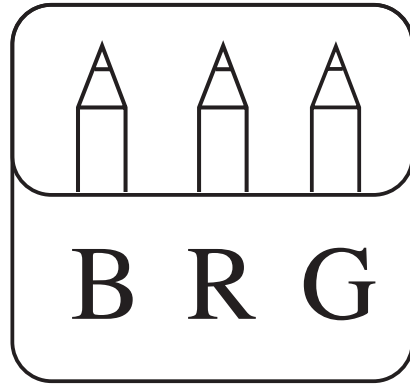

LP 105/4

A 4x10 grid of circles, each containing the number 50. Below each column of four circles is a horizontal curly brace and an empty rectangular box. To the right of the grid, a large curly brace groups all four rows, with two empty rectangular boxes stacked vertically next to it. A horizontal dashed line is positioned to the right of the second empty box.

-----

LP 105/6

a)  $\begin{matrix} \textcircled{1} & \textcircled{1} & \textcircled{1} & \textcircled{1} \\ \textcircled{1} & \textcircled{1} & \textcircled{1} & \textcircled{1} \\ \textcircled{1} & \textcircled{1} & \textcircled{1} & \textcircled{1} \end{matrix}$

b)  $\begin{matrix} \textcircled{10} & \textcircled{10} & \textcircled{10} & \textcircled{10} \\ \textcircled{10} & \textcircled{10} & \textcircled{10} & \textcircled{10} \\ \textcircled{10} & \textcircled{10} & \textcircled{10} & \textcircled{10} \end{matrix}$

c)  $\begin{matrix} \textcircled{100} & \textcircled{100} & \textcircled{100} & \textcircled{100} \\ \textcircled{100} & \textcircled{100} & \textcircled{100} & \textcircled{100} \\ \textcircled{100} & \textcircled{100} & \textcircled{100} & \textcircled{100} \end{matrix}$

---

---

---

---

---

---

---

---

---

---

---

---

A:	<div style="display: flex; justify-content: space-around;"> <div style="border: 1px solid black; padding: 5px 15px;">100</div> <div style="border: 1px solid black; padding: 5px 15px;">100</div> </div>	<div style="border: 1px solid black; padding: 5px 15px;">50</div>	<div style="display: flex; justify-content: space-around;"> <div style="border: 1px solid black; border-radius: 50%; padding: 5px 10px;">5</div> <div style="border: 1px solid black; border-radius: 50%; padding: 5px 10px;">2</div> </div>	}	$3 \times ($ <div style="border: 1px solid black; display: inline-block; width: 40px; height: 20px; vertical-align: middle;"></div> $+$ <div style="border: 1px solid black; display: inline-block; width: 40px; height: 20px; vertical-align: middle;"></div> $+$ <div style="border: 1px solid black; display: inline-block; width: 40px; height: 20px; vertical-align: middle;"></div> $)$
B:	<div style="display: flex; justify-content: space-around;"> <div style="border: 1px solid black; padding: 5px 15px;">100</div> <div style="border: 1px solid black; padding: 5px 15px;">100</div> </div>	<div style="border: 1px solid black; padding: 5px 15px;">50</div>	<div style="display: flex; justify-content: space-around;"> <div style="border: 1px solid black; border-radius: 50%; padding: 5px 10px;">5</div> <div style="border: 1px solid black; border-radius: 50%; padding: 5px 10px;">2</div> </div>		
C:	<div style="display: flex; justify-content: space-around;"> <div style="border: 1px solid black; padding: 5px 15px;">100</div> <div style="border: 1px solid black; padding: 5px 15px;">100</div> </div>	<div style="border: 1px solid black; padding: 5px 15px;">50</div>	<div style="display: flex; justify-content: space-around;"> <div style="border: 1px solid black; border-radius: 50%; padding: 5px 10px;">5</div> <div style="border: 1px solid black; border-radius: 50%; padding: 5px 10px;">2</div> </div>		
	$\underbrace{\hspace{10em}}$	$\underbrace{\hspace{10em}}$	$\underbrace{\hspace{10em}}$		
	$3 \times$ <div style="border: 1px solid black; display: inline-block; width: 40px; height: 20px; vertical-align: middle;"></div>	$+$ $3 \times$ <div style="border: 1px solid black; display: inline-block; width: 40px; height: 20px; vertical-align: middle;"></div>	$+$ $3 \times$ <div style="border: 1px solid black; display: inline-block; width: 40px; height: 20px; vertical-align: middle;"></div>	$=$	<div style="border-top: 1px dashed black; width: 100%; height: 10px;"></div>
	$\underbrace{\hspace{10em}}$	$\underbrace{\hspace{10em}}$	$\underbrace{\hspace{10em}}$		
	<div style="border: 1px solid black; width: 40px; height: 20px; margin: 0 auto;"></div>	<div style="border: 1px solid black; width: 40px; height: 20px; margin: 0 auto;"></div>	<div style="border: 1px solid black; width: 40px; height: 20px; margin: 0 auto;"></div>		



$5 \times 1$

$50 \div 5$

$4 \times 3$

$21 \div 3$

$25 \div 5$

$10 \times 2$

$40 \div 4$

$2 \times 6$

$42 \div 6$

$10 \times 10$

$7 \times 5$

$6 \div 2$

$9 \times 2$

$63 \div 9$

$27 \div 3$

$5 \times 9$

$80 \div 8$

$7 \times 3$

$18 \div 6$

$4 \times 8$

$5 \times 2$

$35 \div 5$

$6 \times 7$

$18 \div 9$

$56 \div 8$

$2 \times 3$

$8 \div 2$

$7 \times 9$

$18 \div 3$

$10 \times 0$

a)  $\textcircled{2}$   $\textcircled{2}$   $\textcircled{2}$

$\textcircled{20}$   $\textcircled{20}$   $\textcircled{20}$

$\textcircled{200}$   $\textcircled{200}$   $\textcircled{200}$

b)  $\textcircled{2}$   $\textcircled{2}$   $\textcircled{2}$   
 $\textcircled{2}$   $\textcircled{2}$   $\textcircled{2}$

$\textcircled{20}$   $\textcircled{20}$   $\textcircled{20}$   
 $\textcircled{20}$   $\textcircled{20}$   $\textcircled{20}$

$\textcircled{200}$   $\textcircled{200}$   $\textcircled{200}$   
 $\textcircled{200}$   $\textcircled{200}$   $\textcircled{200}$

a)

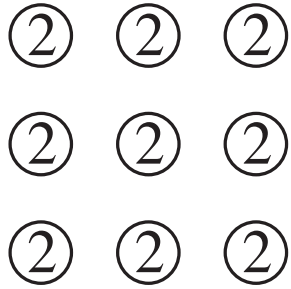

b)

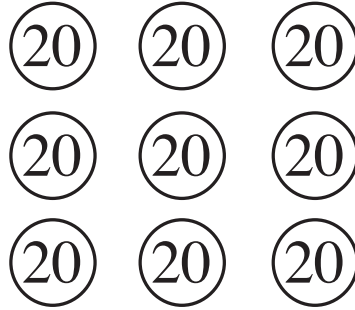

c)

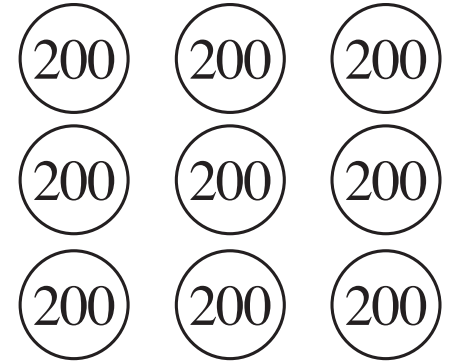

---

---

---

---

---

---

---

---

---

a)  $5 \times 3 = \square$     $50 \times 3 = \square$     $5 \times 30 = \square$     $5 \times 300 = \square$     $50 \times 30 = \square$

b)  $8 \times 2 = \square$     $80 \times 2 = \square$     $8 \times 20 = \square$     $8 \times 200 = \square$     $80 \times 20 = \square$

c)  $3 \times 3 = \square$     $30 \times 3 = \square$     $3 \times 30 = \square$     $3 \times 300 = \square$     $30 \times 30 = \square$

d)  $4 \times 5 = \square$     $40 \times 5 = \square$     $4 \times 50 = \square$     $4 \times 500 = \square$     $40 \times 50 = \square$

LP 106/7a

a)  $5 \times 3 = \boxed{15}$     $50 \times 3 = \boxed{150}$     $5 \times 30 = \boxed{150}$     $5 \times 300 = \boxed{1500}$     $50 \times 30 = \boxed{1500}$

b)  $8 \times 2 = \boxed{16}$     $80 \times 2 = \boxed{160}$     $8 \times 20 = \boxed{160}$     $8 \times 200 = \boxed{1600}$     $80 \times 20 = \boxed{1600}$

c)  $3 \times 3 = \boxed{9}$     $30 \times 3 = \boxed{90}$     $3 \times 30 = \boxed{90}$     $3 \times 300 = \boxed{900}$     $30 \times 30 = \boxed{900}$

d)  $4 \times 5 = \boxed{20}$     $40 \times 5 = \boxed{200}$     $4 \times 50 = \boxed{200}$     $4 \times 500 = \boxed{2000}$     $40 \times 50 = \boxed{2000}$

LP 106/7b

John

 $\textcircled{10}$   $\textcircled{2}$  $\textcircled{10}$   $\textcircled{2}$  $\textcircled{10}$   $\textcircled{2}$  $\textcircled{10}$   $\textcircled{2}$ 

Katy

 $\textcircled{100}$   $\textcircled{20}$  $\textcircled{100}$   $\textcircled{20}$  $\textcircled{100}$   $\textcircled{20}$  $\textcircled{100}$   $\textcircled{20}$ 

Lorna

 $\textcircled{50}$   $\textcircled{2}$   $\textcircled{1}$  $\textcircled{50}$   $\textcircled{2}$   $\textcircled{1}$  $\textcircled{50}$   $\textcircled{2}$   $\textcircled{1}$ 

Michael

 $\textcircled{500}$   $\textcircled{20}$   $\textcircled{10}$  $\textcircled{500}$   $\textcircled{20}$   $\textcircled{10}$  $\textcircled{500}$   $\textcircled{20}$   $\textcircled{10}$ 

John:

---

Katy:

---

Lorna:

---

Michael:

---

$$\begin{array}{|c|c|} \hline & \\ \hline \end{array} \times \square =$$

$$\begin{array}{|c|c|} \hline & \\ \hline \end{array} \times \square + \square \times \square$$

$$= \begin{array}{|c|c|c|} \hline & & \\ \hline \end{array} + \begin{array}{|c|c|} \hline & \\ \hline \end{array}$$

$$= \begin{array}{|c|c|c|} \hline & & \\ \hline \end{array}$$

$$\begin{array}{|c|c|} \hline & \\ \hline \end{array} \times \square = \begin{array}{|c|c|c|} \hline & & \\ \hline \end{array}$$

a)  $40 \times 3 = \square$      $40 \times 6 = \square$      $40 \times 12 = \square$

b)  $30 \times 4 = \square$      $30 \times 8 = \square$      $30 \times 12 = \square$

c)  $50 \times 2 = \square$      $50 \times 6 = \square$      $50 \times 20 = \square$

$$\text{a) } 6 \times 28 = \square \quad 3 \times 28 = \square \quad 6 \times 14 = \square$$

$$6 \times 280 = \square \quad 3 \times 280 = \square \quad 6 \times 140 = \square$$

$$\text{b) } 4 \times 16 = \square \quad 8 \times 8 = \square \quad 2 \times 32 = \square$$

$$4 \times 160 = \square \quad 8 \times 80 = \square \quad 2 \times 320 = \square$$

$$\text{c) } 6 \times 16 = \square \quad 6 \times 15 = \square \quad 5 \times 15 = \square$$

$$6 \times 160 = \square \quad 6 \times 150 = \square \quad 5 \times 150 = \square$$



a)  $227 \times 4$

i) Rounding 227 to the nearest hundred:

$$P \approx \boxed{\phantom{00}} \times 4 = \boxed{\phantom{00}} \quad P \quad \bigcirc \quad \boxed{\phantom{00}}$$

ii) Rounding 227 to the nearest ten:

$$P \approx \boxed{\phantom{00}} \times 4 = \boxed{\phantom{00}} \quad P \quad \bigcirc \quad \boxed{\phantom{00}}$$

b)  $468 \times 6$

i) Rounding 468 to the nearest hundred:

$$P \approx \boxed{\phantom{00}} \times 6 = \boxed{\phantom{00}} \quad P \quad \bigcirc \quad \boxed{\phantom{00}}$$

ii) Rounding 468 to the nearest ten:

$$P \approx \boxed{\phantom{00}} \times 6 = \boxed{\phantom{00}} \quad P \quad \bigcirc \quad \boxed{\phantom{00}}$$

a)  $162 \times 5 \approx \square \times 5 = \square$        $162 \times 5 \bigcirc \square$

b)  $177 \times 4 \approx \square \times 4 = \square$        $177 \times 4 \bigcirc \square$

c)  $315 \times 3 \approx \square \times 3 = \square$        $315 \times 3 \bigcirc \square$

d)  $231 \times 4 \approx \square \times 4 = \square$        $231 \times 4 \bigcirc \square$

100

100

20

10

20

10

5

5

Make two copies on card.

a)

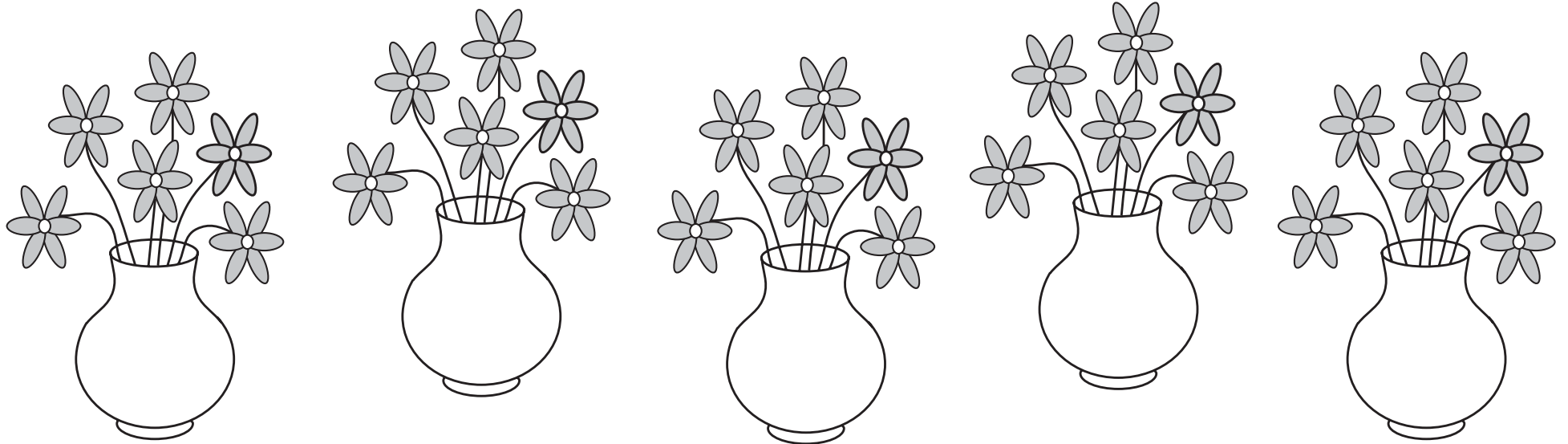

b)

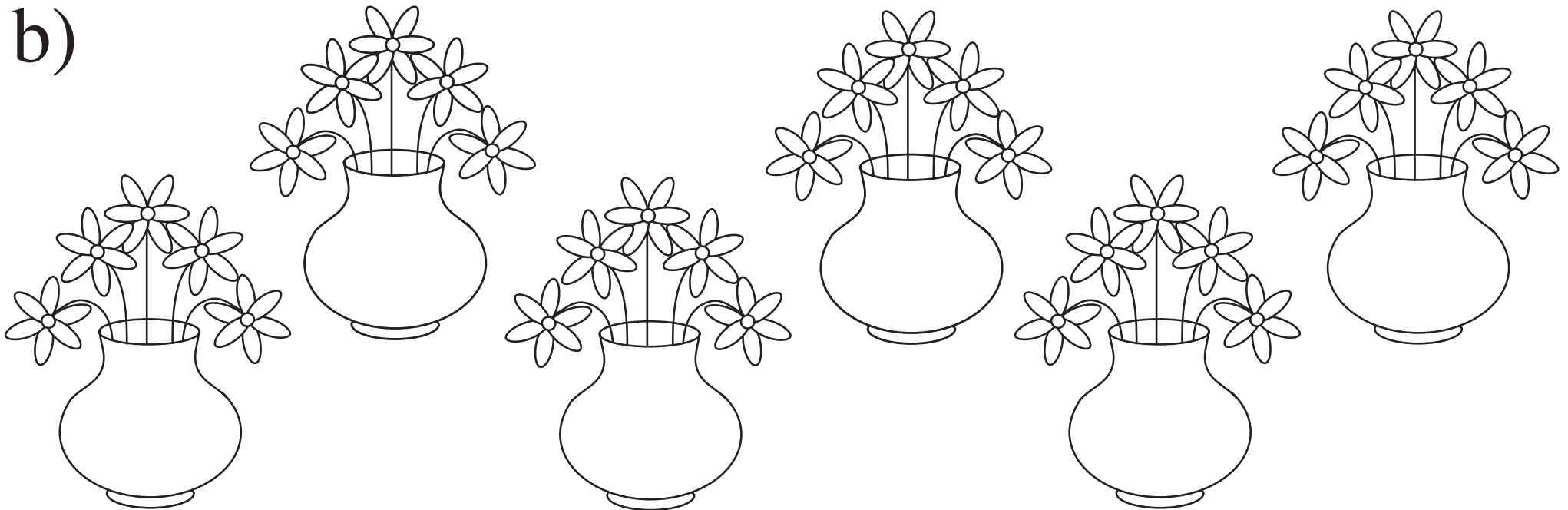

$$436 \times 5$$

$$436 \times 5$$

$$436 \times 5$$

$$436 \times 5$$

1800

2000

2400

2100

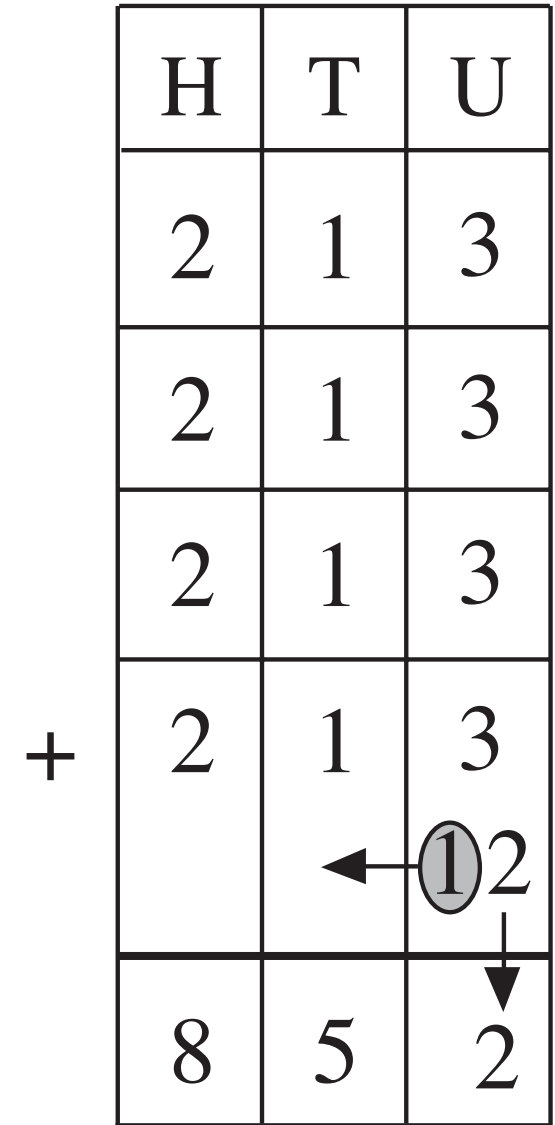
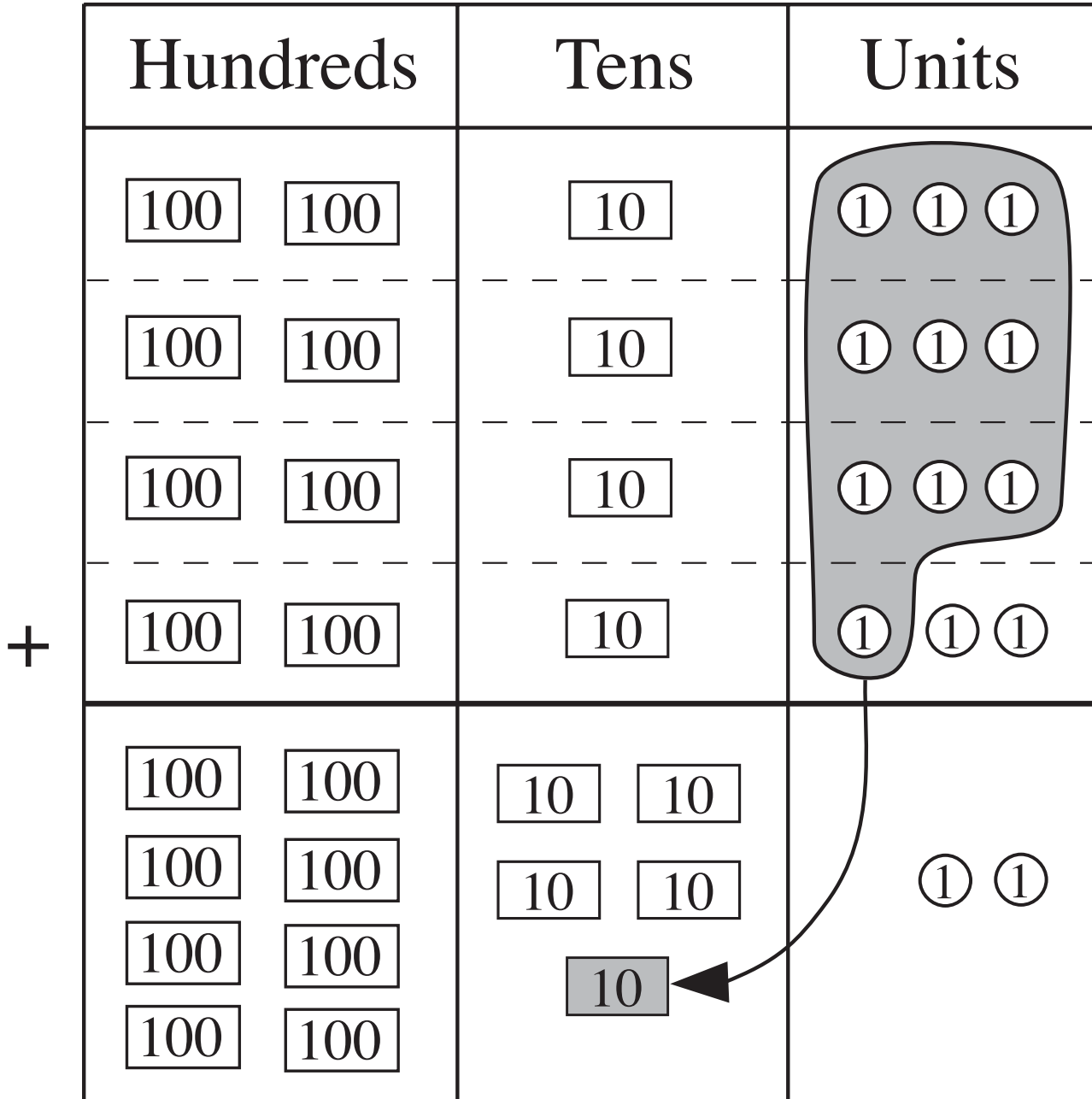

H	T	U
2	1	3
2	1	3
2	1	3
2	1	3
8	5	2

+

H	T	U
2	1	3
8	5	2

× 4

2	1	3
8	5	2

× 4

Hundreds	Tens	Units
100		

H	T	U

+

H	T	U

 $\times 3$ 

 $\times 3$



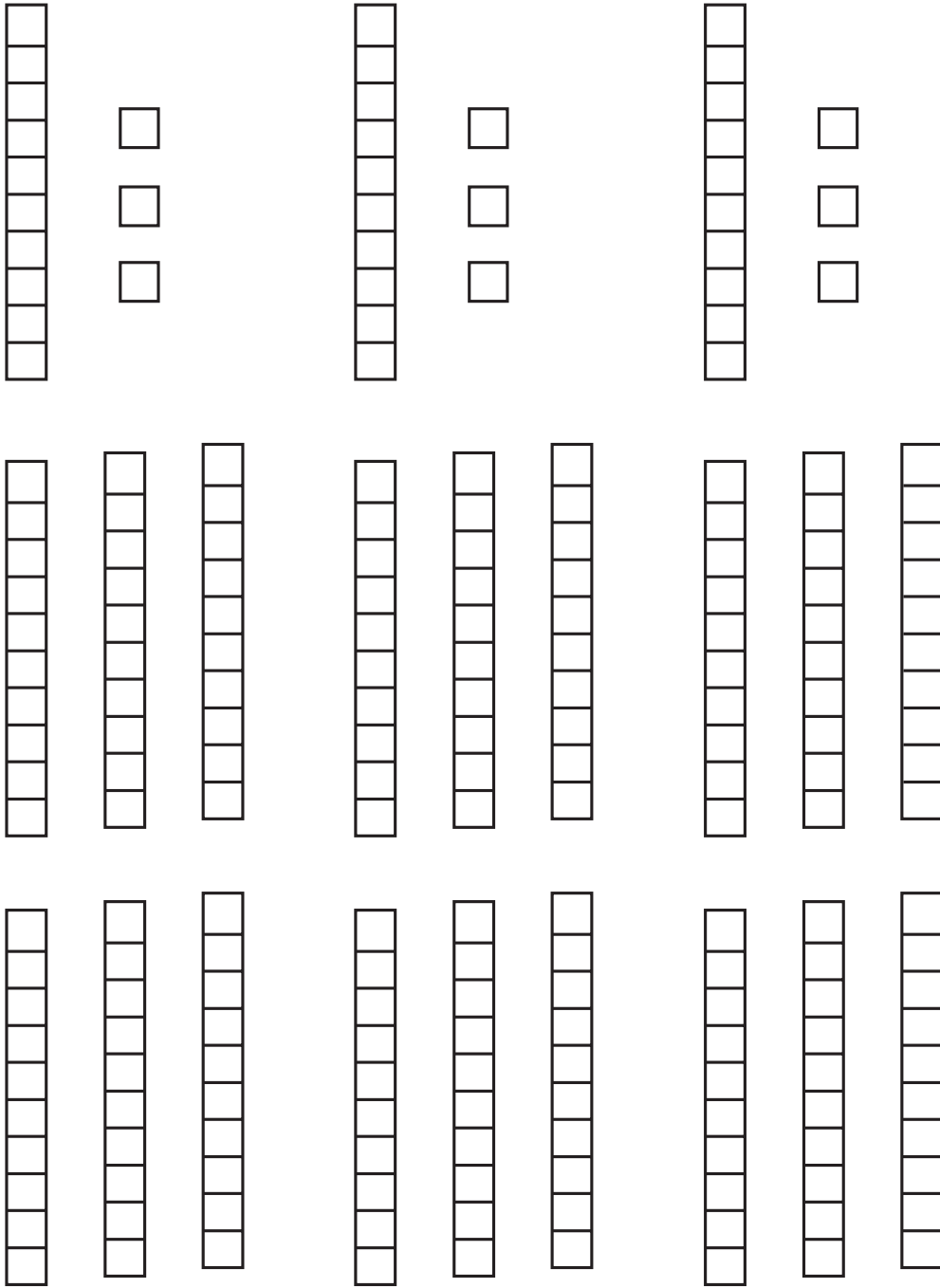

$$73 \times 3 = \begin{array}{|c|c|c|} \hline & & \\ \hline & & \\ \hline & & \\ \hline \end{array}$$

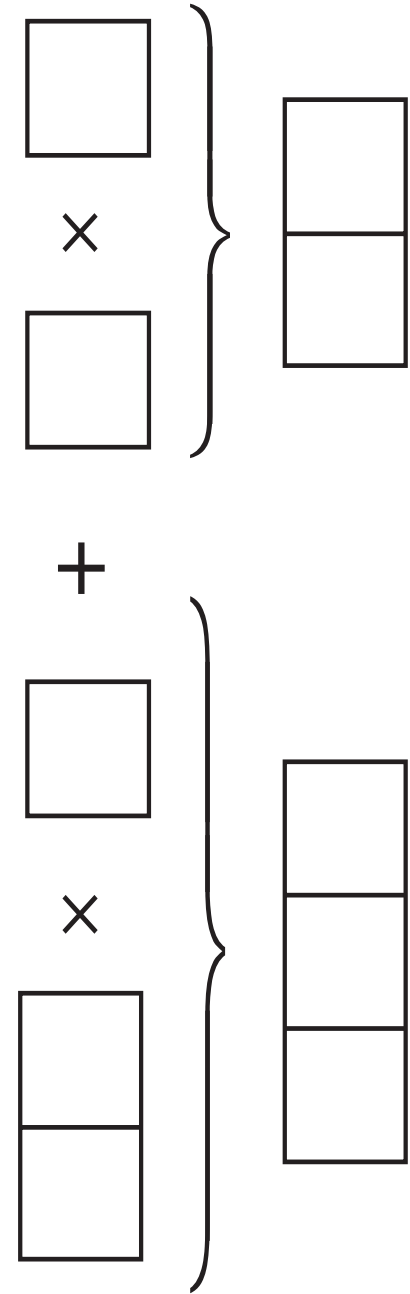

a)

	2	0	2
	2	0	2
	2	0	2
+	2	0	2
<hr/>			

 E: 

--	--	--	--

	2	0	2	×	
<hr/>					

b)

	3	0	2
	3	0	2
+	3	0	2
<hr/>			

 E: 

--	--	--	--

	3	0	2	×	
<hr/>					

c)

	4	2	3
+	4	2	3
<hr/>			

 E: 

--	--	--	--

	4	2	3	×	
<hr/>					

d)

	2	0	1
	2	0	1
	2	0	1
	2	0	1
+	2	0	1
<hr/>			

 E: 

--	--	--	--

	2	0	1	×	
<hr/>					

a)

H	T	U		
	8	2	×	4

b)

H	T	U		
	9	1	×	7

c)

H	T	U		
	6	2	×	3

d)

H	T	U		
	6	2	×	4

e)

H	T	U		
	9	1	×	8

f)

H	T	U			
	1	2	2	×	4

g)

Th	H	T	U		
	3	2	1	×	3

h)

Th	H	T	U		
	3	2	1	×	4

i)

Th	H	T	U		
	5	2	3	×	3

j)

Th	H	T	U		
	4	0	2	×	4

k)

Th	H	T	U		
	4	0	3	×	4

l)

Th	H	T	U		
	6	1	2	×	3

$a$	423	211	322	323	514	73	441
$b$	2	5	4	3			
$c$	846	1055			1028	219	882

a) *E*:

	4	2	3
	4	2	3
+	4	2	3
<hr/>			

	4	2	3	×	
<hr/>					

 b) *E*:

	3	2	1
	3	2	1
	3	2	1
+	3	2	1
<hr/>			

	3	2	1	×	
<hr/>					

 c) *E*:

	3	0	9
	3	0	9
+	3	0	9
<hr/>			

	3	0	9	×	
<hr/>					

 d) *E*:

	1	4	1
	1	4	1
	1	4	1
	1	4	1
	1	4	1
	1	4	1
+	1	4	1
<hr/>			

	1	4	1	×	
<hr/>					

a)

	7	1
	7	1
	7	1
	7	1
	7	1
+	7	1

E:

	7	1	×	6

b)

E:

	2	0	1
	2	0	1
	2	0	1
+	2	0	1

2	0	1	×	

c)

E:

	5	3	4
+	5	3	4

	5	3	4	×	

d)

E:

	2	1	1
	2	1	1
	2	1	1
	2	1	1
+	2	1	1

2	1	1	×	

a) *E:*

--	--	--

4	2	2	×	2

*E:*

--	--	--	--

	4	2	2	×	3

*E:*

--	--	--	--

	4	2	2	×	4

b) *E:*

--	--	--

3	2	1	×	3

*E:*

--	--	--	--

	4	2	1	×	3

*E:*

--	--	--	--

	6	2	1	×	3

c) *E:*

--	--	--

	8	4	×	2

*E:*

--	--	--	--

	8	0	4	×	2

*E:*

--	--	--	--

	4	0	2	×	4

Thousands	Hundreds	Tens	Units
	<div style="display: flex; flex-wrap: wrap; justify-content: space-around;"> <div style="border: 1px solid black; padding: 2px; margin: 2px;">100</div> <div style="border: 1px solid black; padding: 2px; margin: 2px;">100</div> <div style="border: 1px solid black; padding: 2px; margin: 2px;">100</div> <div style="border: 1px solid black; padding: 2px; margin: 2px;">100</div> <div style="border: 1px solid black; padding: 2px; margin: 2px;">100</div> </div>	<div style="display: flex; flex-wrap: wrap; justify-content: space-around;"> <div style="border: 1px solid black; padding: 2px; margin: 2px;">10</div> <div style="border: 1px solid black; padding: 2px; margin: 2px;">10</div> <div style="border: 1px solid black; padding: 2px; margin: 2px;">10</div> </div>	<div style="display: flex; flex-wrap: wrap; justify-content: space-around;"> <div style="border: 1px solid black; border-radius: 50%; padding: 2px; margin: 2px;">①</div> <div style="border: 1px solid black; border-radius: 50%; padding: 2px; margin: 2px;">①</div> <div style="border: 1px solid black; border-radius: 50%; padding: 2px; margin: 2px;">①</div> <div style="border: 1px solid black; border-radius: 50%; padding: 2px; margin: 2px;">①</div> <div style="border: 1px solid black; border-radius: 50%; padding: 2px; margin: 2px;">①</div> <div style="border: 1px solid black; border-radius: 50%; padding: 2px; margin: 2px;">①</div> </div>
+	<div style="display: flex; flex-wrap: wrap; justify-content: space-around;"> <div style="border: 1px solid black; padding: 2px; margin: 2px;">100</div> <div style="border: 1px solid black; padding: 2px; margin: 2px;">100</div> <div style="border: 1px solid black; padding: 2px; margin: 2px;">100</div> <div style="border: 1px solid black; padding: 2px; margin: 2px;">100</div> <div style="border: 1px solid black; padding: 2px; margin: 2px;">100</div> </div>	<div style="display: flex; flex-wrap: wrap; justify-content: space-around;"> <div style="border: 1px solid black; padding: 2px; margin: 2px;">10</div> <div style="border: 1px solid black; padding: 2px; margin: 2px;">10</div> <div style="border: 1px solid black; padding: 2px; margin: 2px;">10</div> </div>	<div style="display: flex; flex-wrap: wrap; justify-content: space-around;"> <div style="border: 1px solid black; border-radius: 50%; padding: 2px; margin: 2px;">①</div> <div style="border: 1px solid black; border-radius: 50%; padding: 2px; margin: 2px;">①</div> <div style="border: 1px solid black; border-radius: 50%; padding: 2px; margin: 2px;">①</div> <div style="border: 1px solid black; border-radius: 50%; padding: 2px; margin: 2px;">①</div> <div style="border: 1px solid black; border-radius: 50%; padding: 2px; margin: 2px;">①</div> <div style="border: 1px solid black; border-radius: 50%; padding: 2px; margin: 2px;">①</div> </div>

Th	H	T	U

+

Th	H	T	U

×

×



×

+

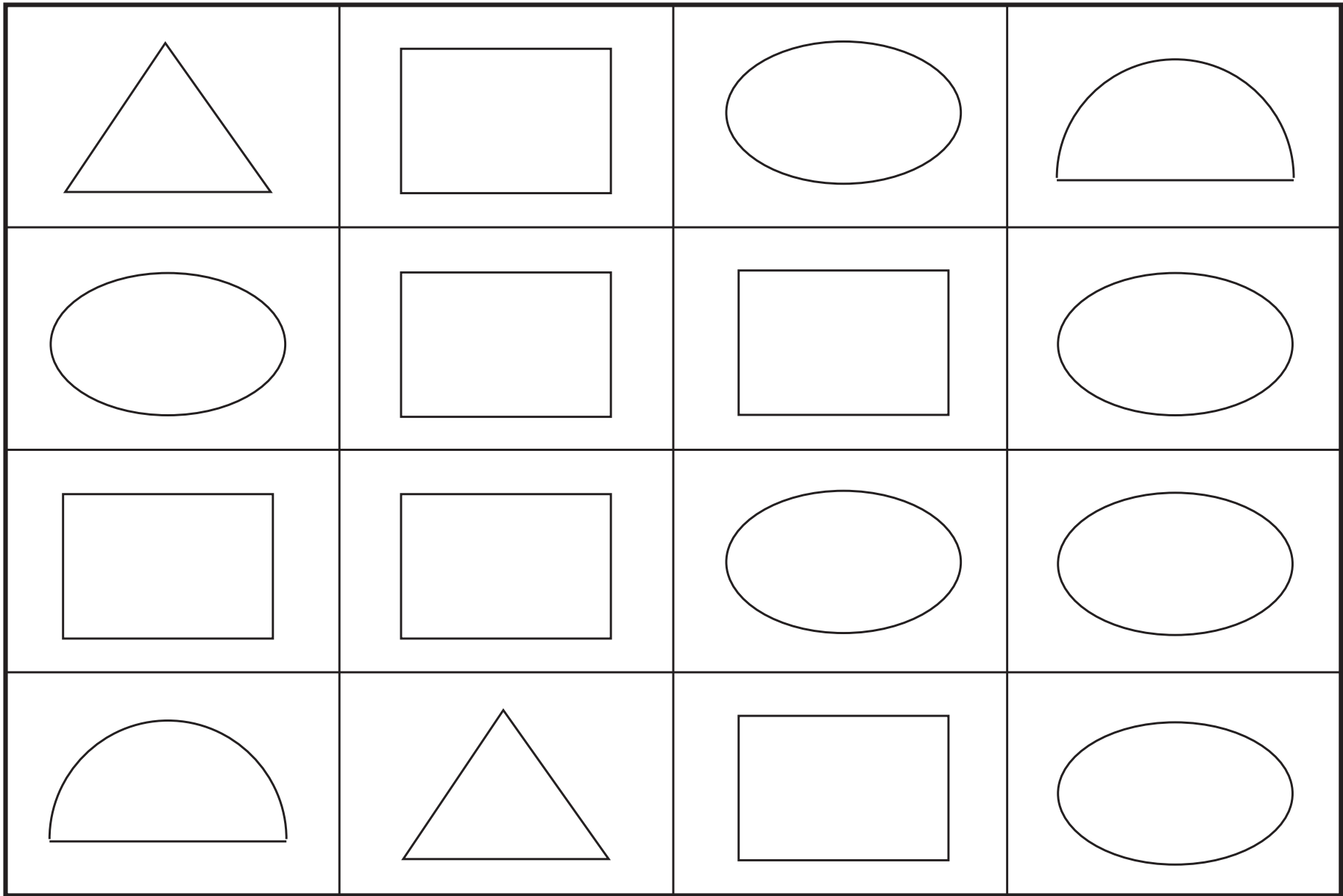

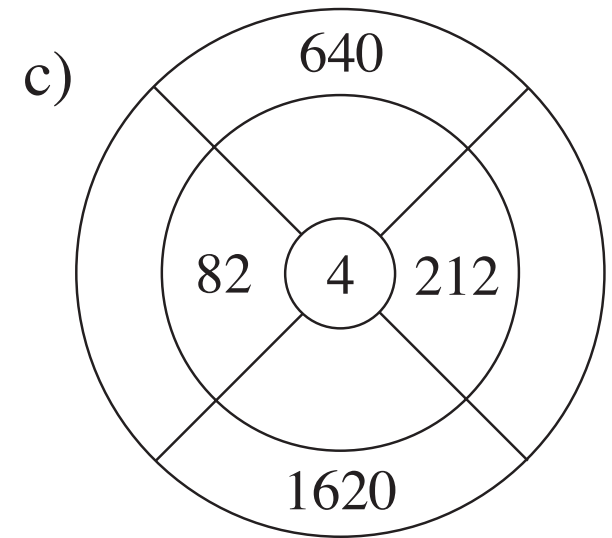
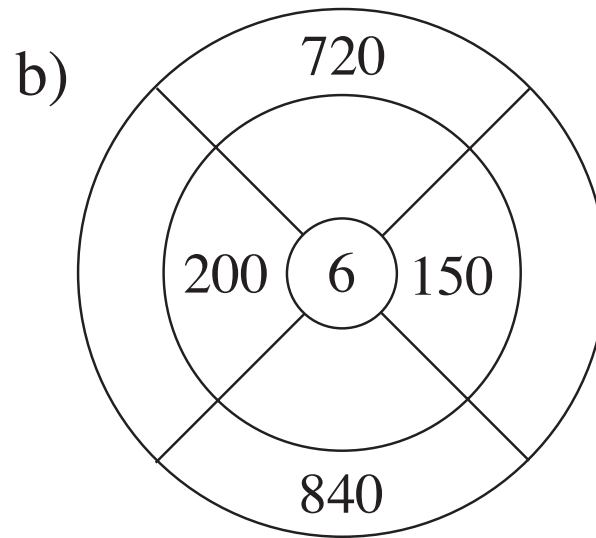
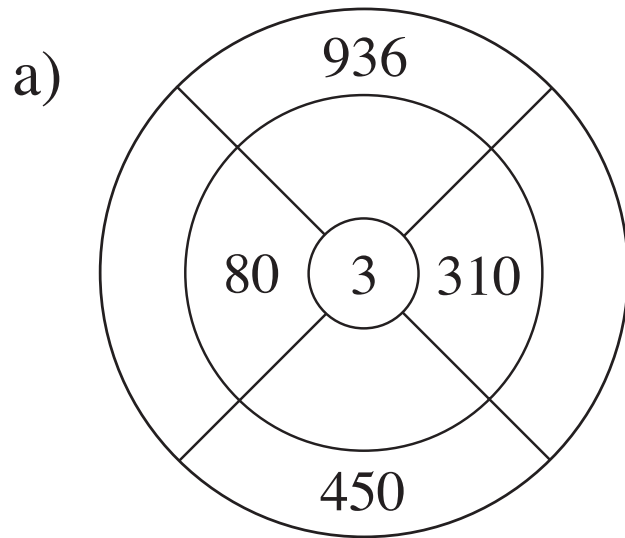

$a$	$b$	$c$	$a \times c$	$a \times b$	$b \times c$
400	5	3			
450	6	4			



LP 111/4

a)

		6	4	×	3
1	8	1	2		

b)

	5	0	2	×	3
	1	5	6		

c)

	4	6	4	×	3
1	3	9	2		

d)

	1	7	0	×	3
5	1	3			

e)

	4	0	5	×	3
2	2	1	5		

f)

	3	1	6	×	4
1	2	4	4		

LP 111/5

a)

	2	6	×	5

	5	2	×	6

	4	4	×	4

1	0	6	×	9

b)

	4	4	2	×	2

	2	0	8	×	7

	4	0	7	×	3

	3	0	5	×	0

c)

	2	0	7	×	9

	1	1	6	×	6

	2	7	5	×	1

	3	0	7	×	6

a)

			×	2	
8	2	6			

			×	3	
9	6	3			

2	3	4	×		
4	6	8			

1	0	6	×		
6	3	6			

b)

			×	3	
6	1	2			

			×	4	
8	6	4			

1	3	5	×		
2	7	0			

2	1	7	×		
8	6	8			

c)

			×	4	
6	0	8			

			×	5	
8	5	5			

1	5	1	×		
9	0	6			

1	8	3	×		
5	4	9			

a)

2	3	×	2
			0

3		×	3
	2		6

b)

	2	3	×	
8		2		

	6	×	5
8			0

c)

3		×	3
	4	2	

	8	×	6
4			8

d)

	9	×	
9	8	1	

	8	×	
6	3		4



Time (seconds)	1	2	5	0	4	10
Distance (mm)	217					