

a)

	4		×	
4	3	8		

b)

		2		×	2
	0		6		

c)

	2		4	×	
		2	0		

d)

	3		×	4
9	4	8		

e)

1		9	×	6
8	9			

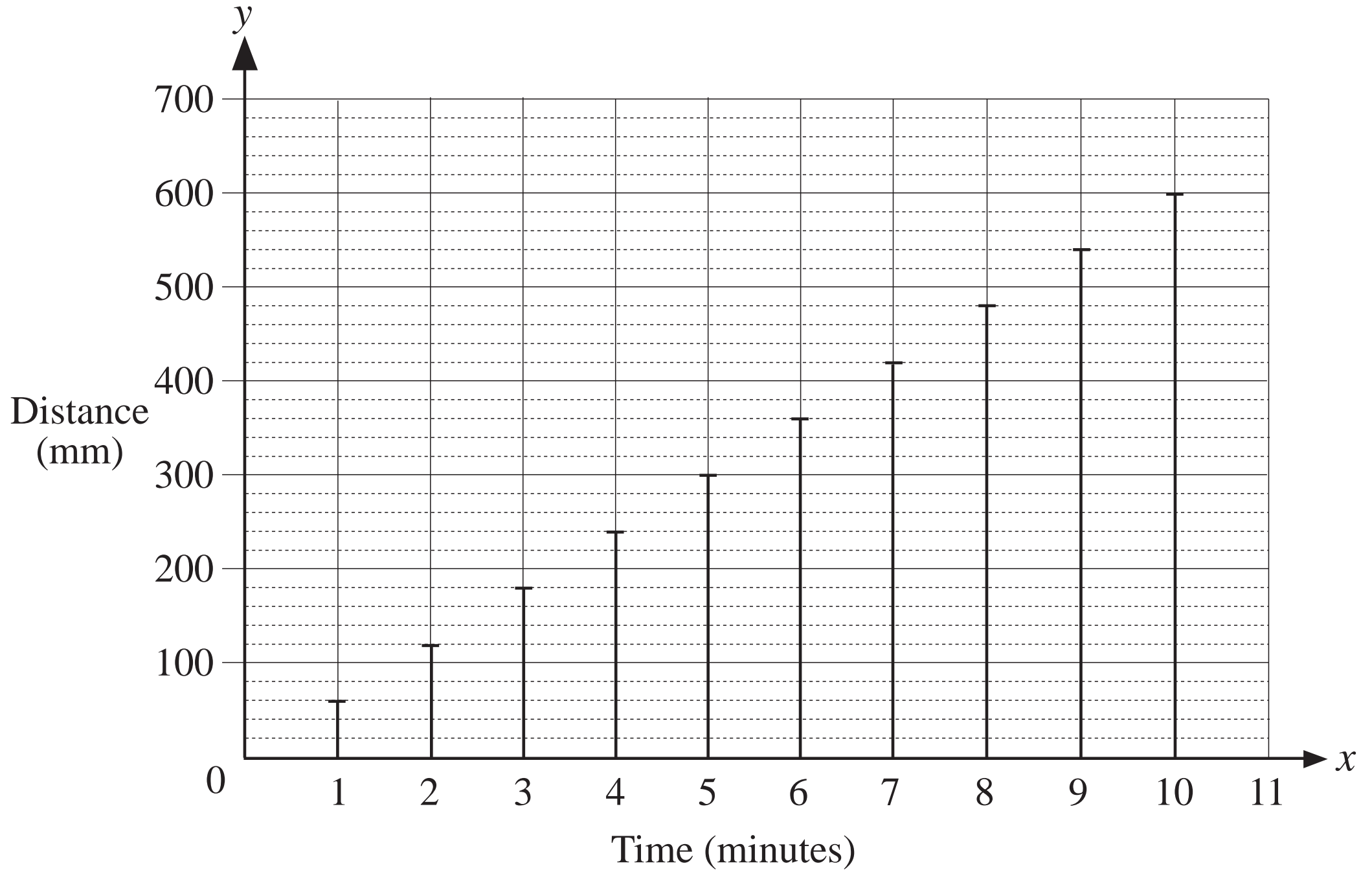

Time (minutes)	0	1										
Distance (mm)												

LP 141/5b

Time (minutes)	0	10	20	30	40	50	60	70	80
Distance (km)	0								

LP 141/6a

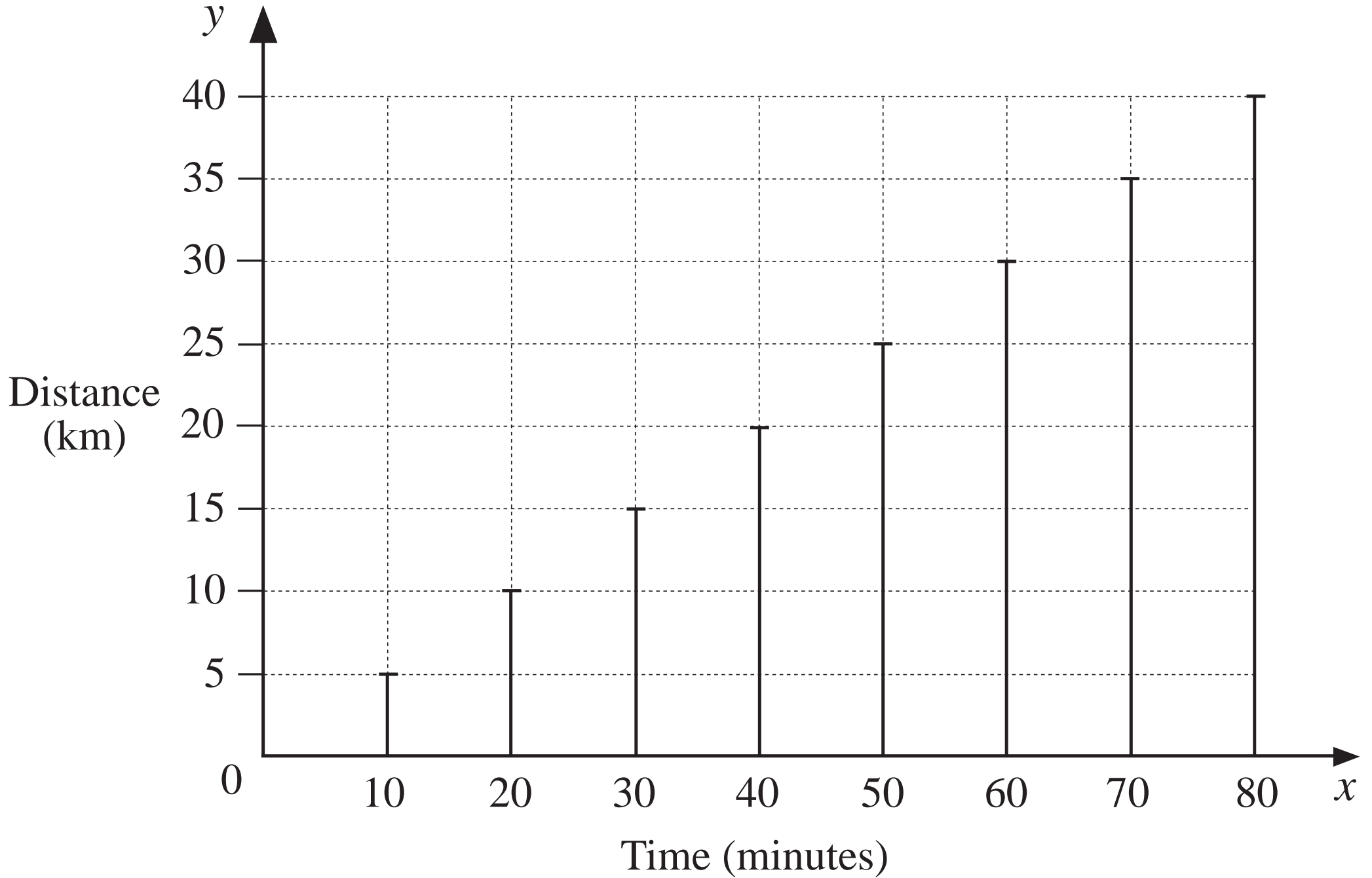

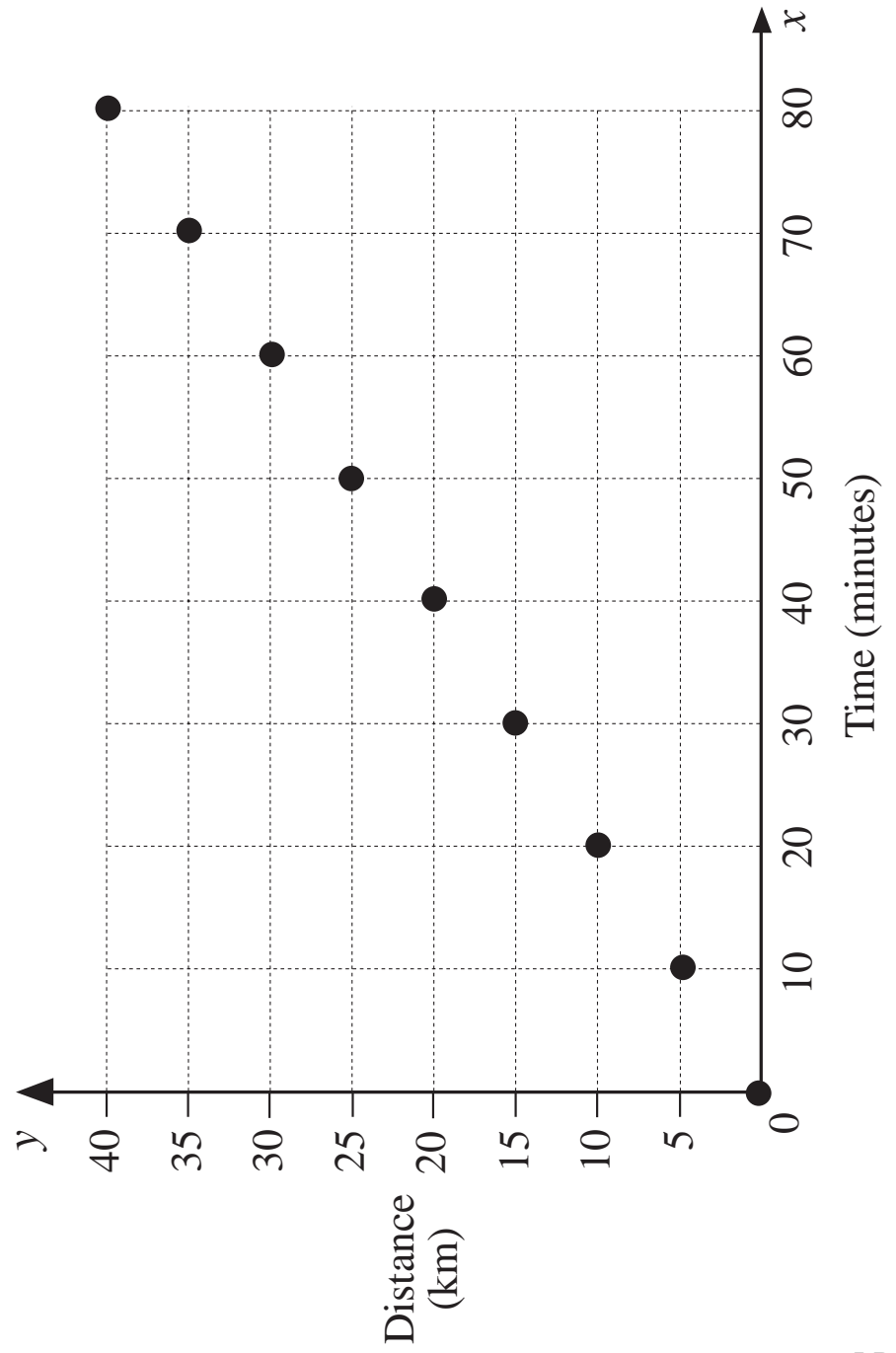
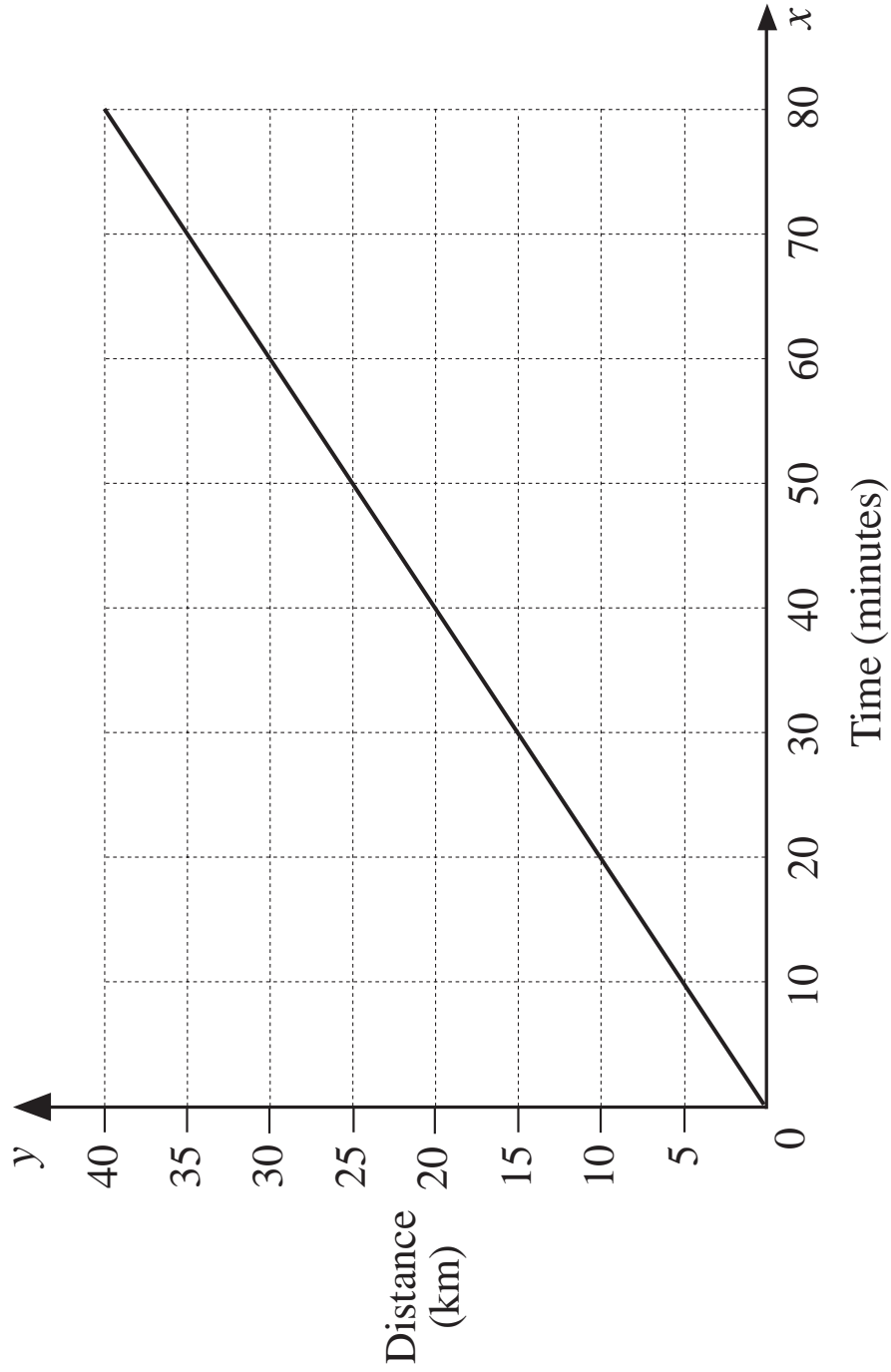

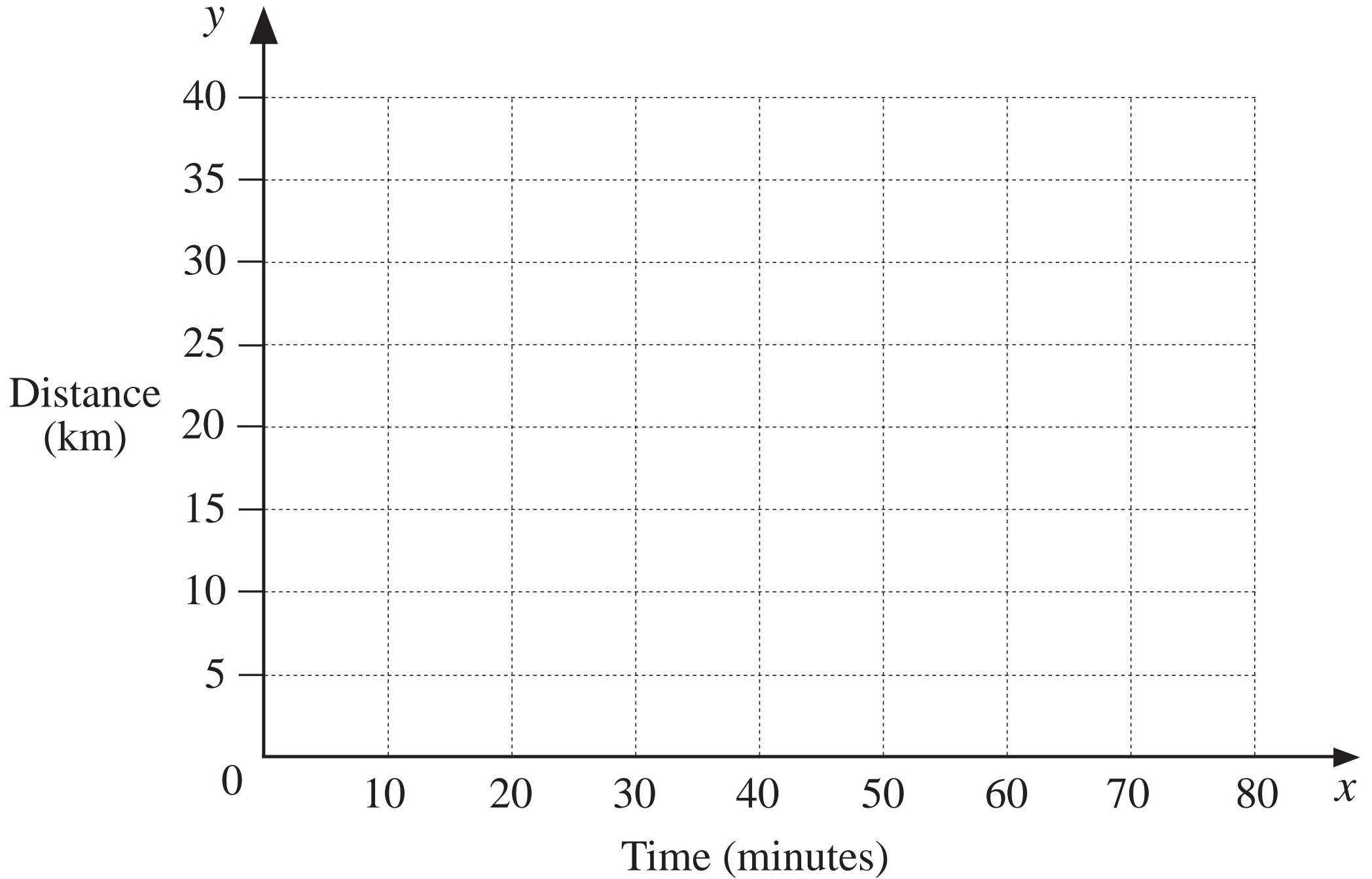

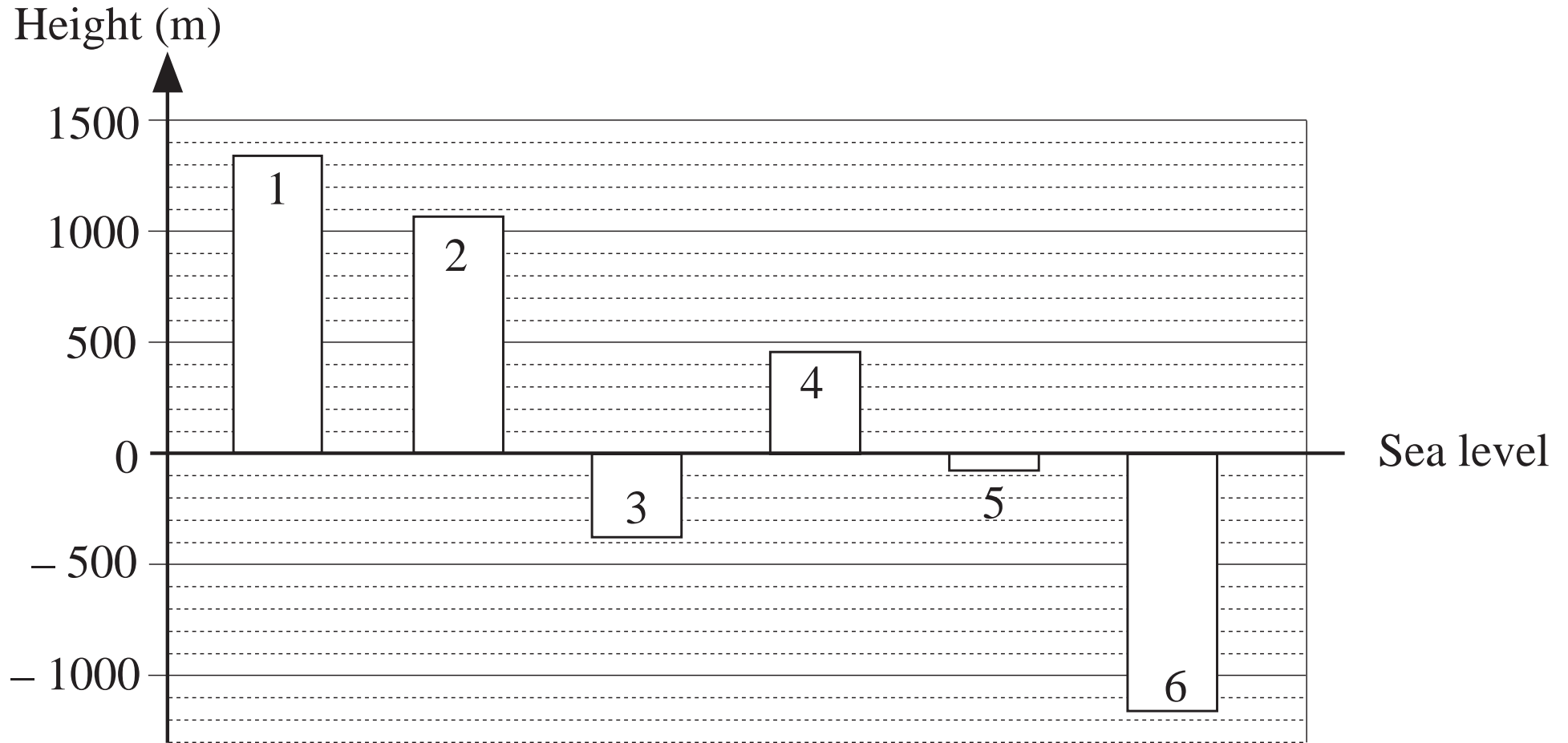

1. Ben Nevis \approx m

2. Mount Snowdon \approx m

3. The Dead Sea \approx m

4. Hay Tor, Dartmoor \approx m

5. Death Valley, USA \approx m

6. Straits of Gibraltar \approx m

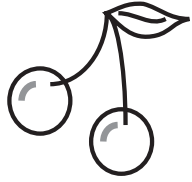

Quantity (g)	100	300	800	600	500	1000
Price (pence)	30	90	240	180	150	300

LP 141/8a

Time (minutes)	1	2	3	4	5	6	7	8	9	10	0
Distance (cm)	165										

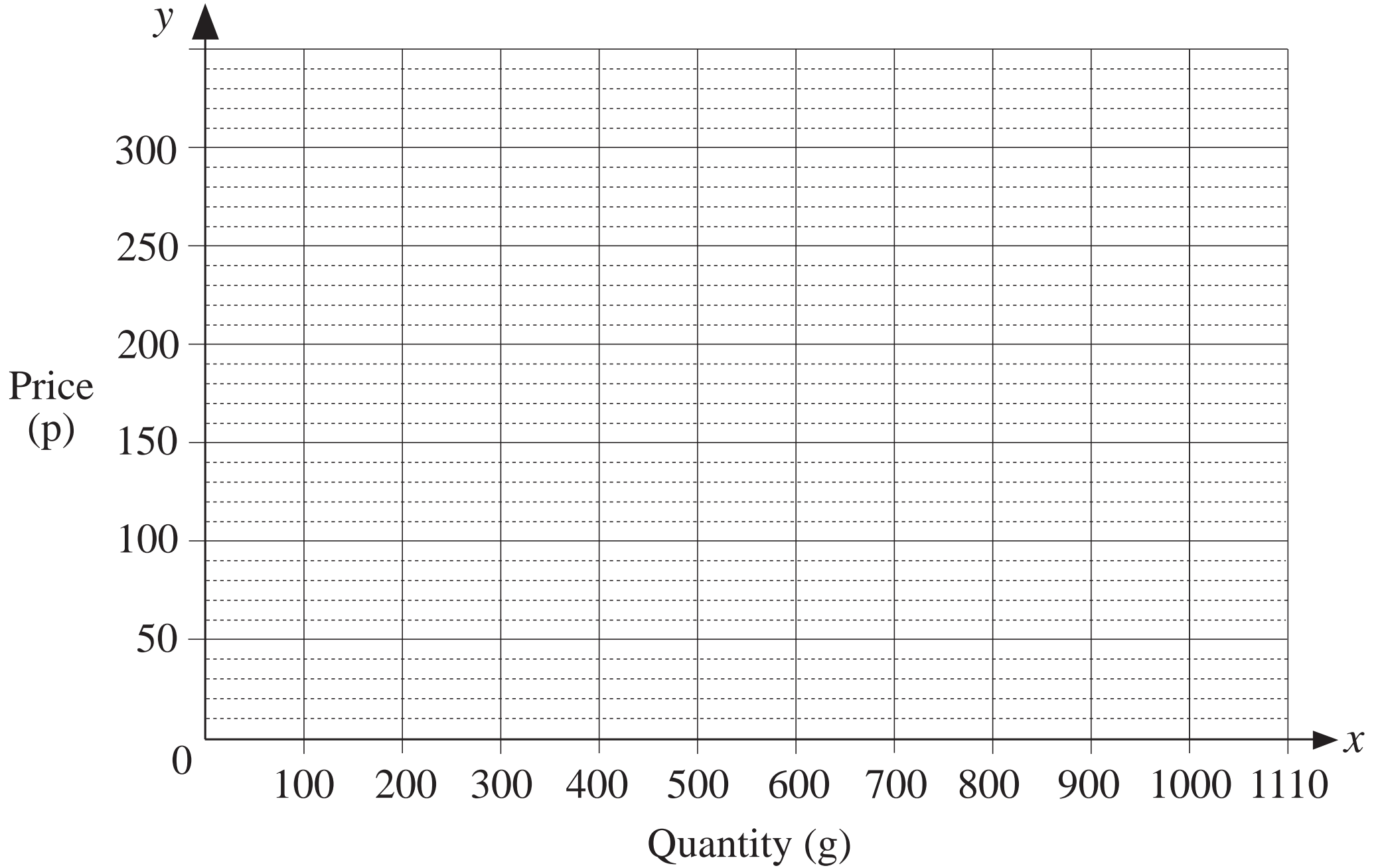

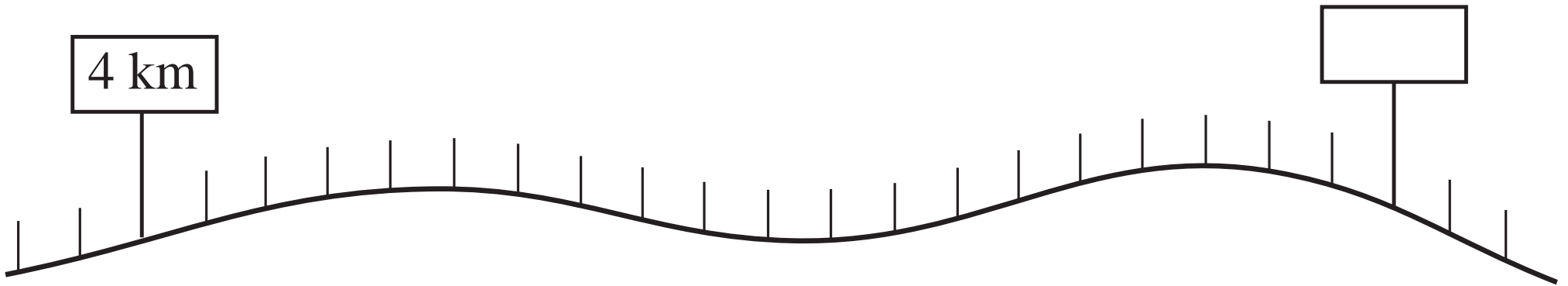

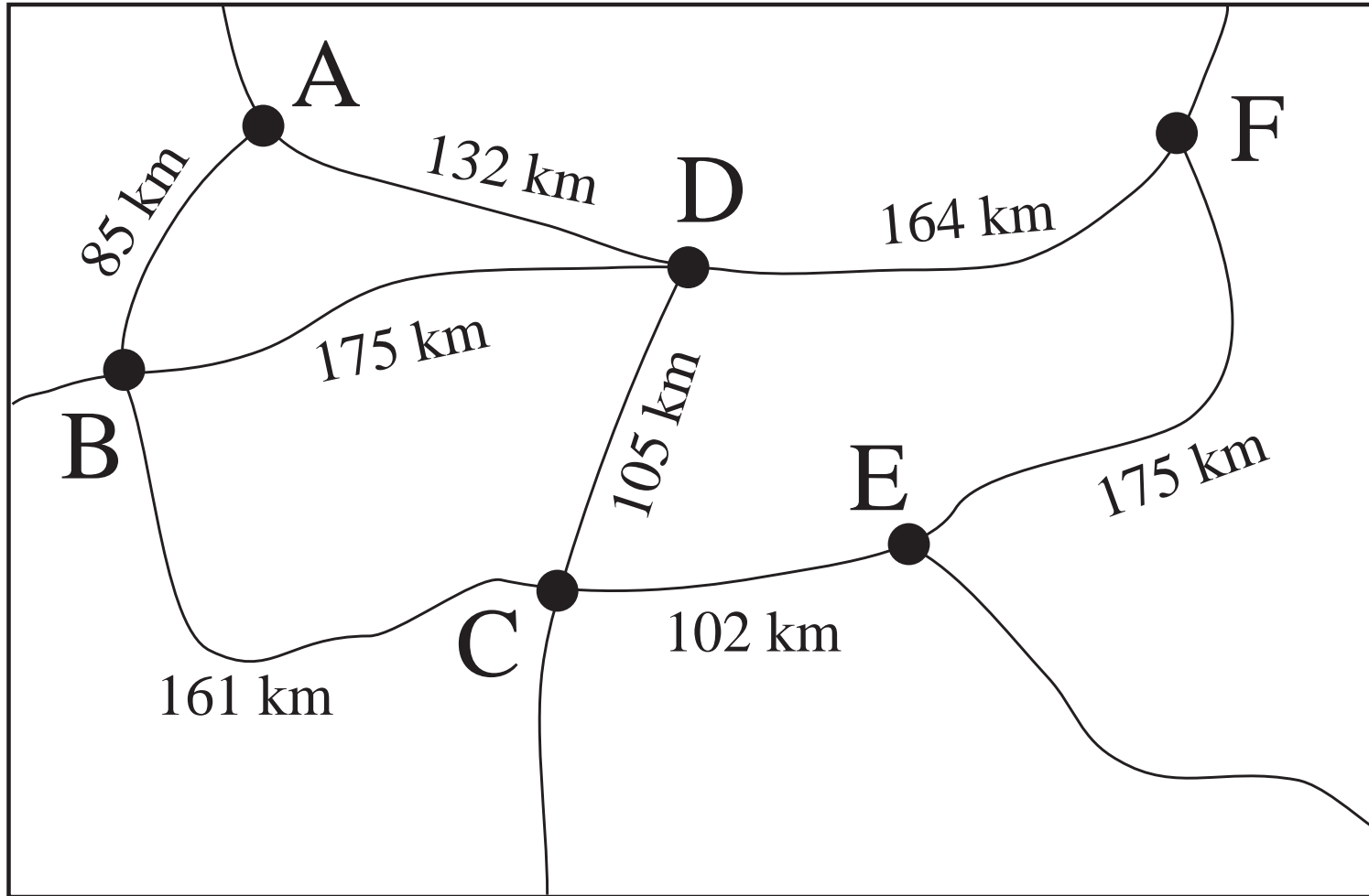

Scale: 1 mm \rightarrow 2 km

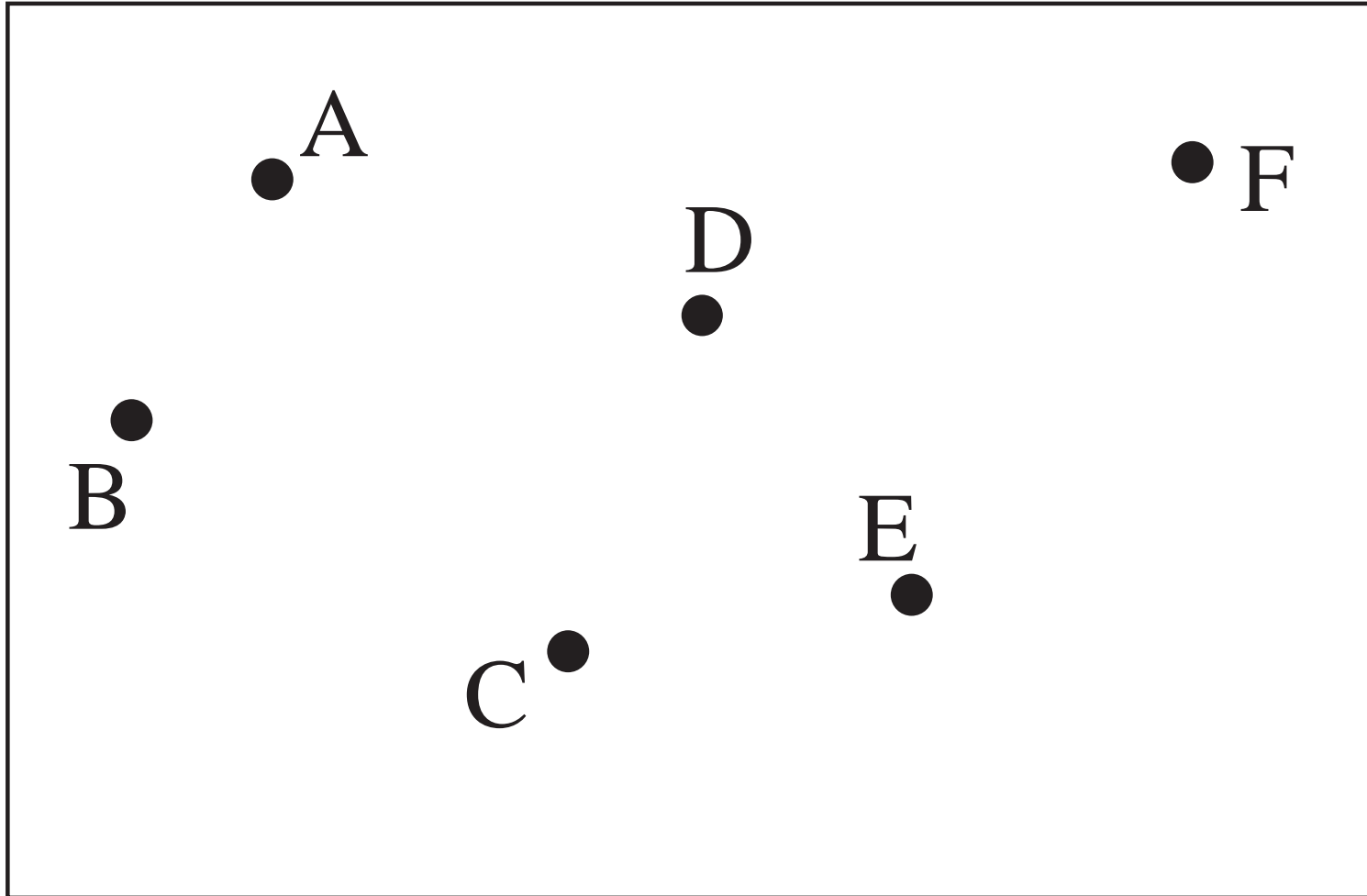

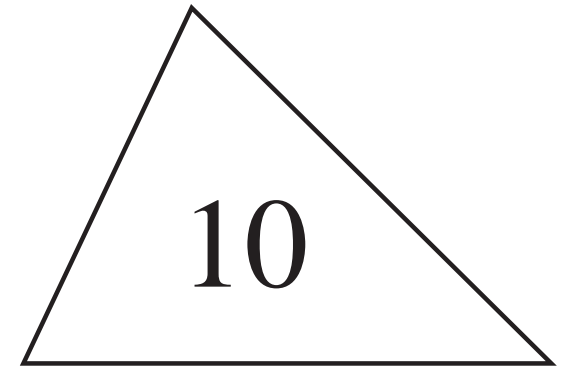
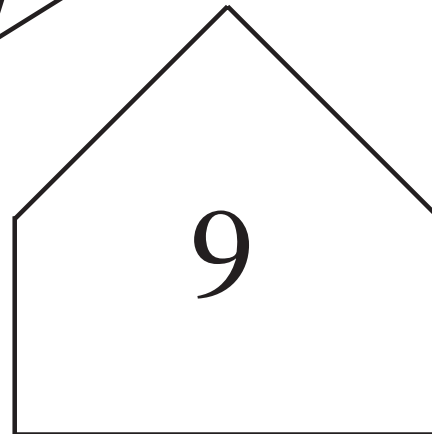
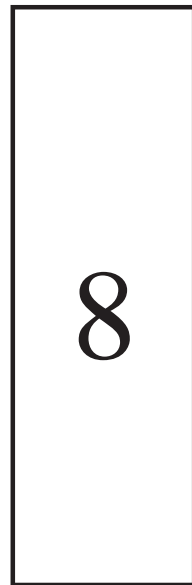
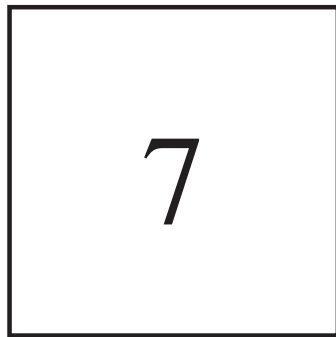
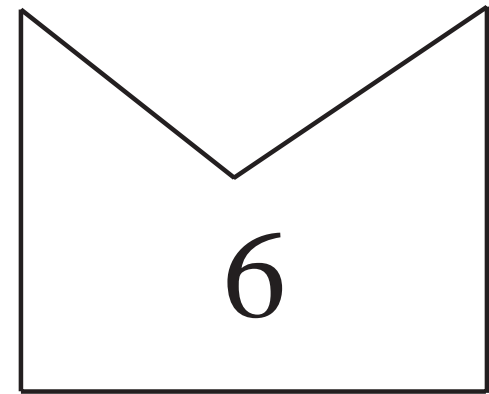
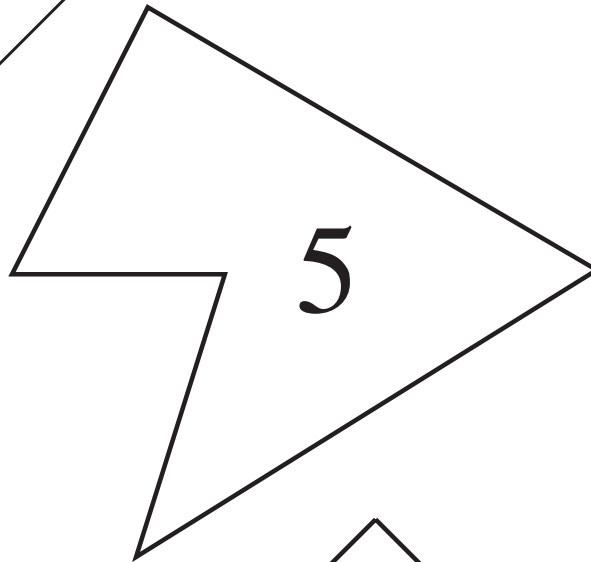
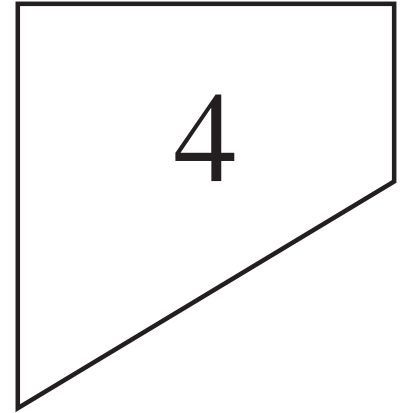
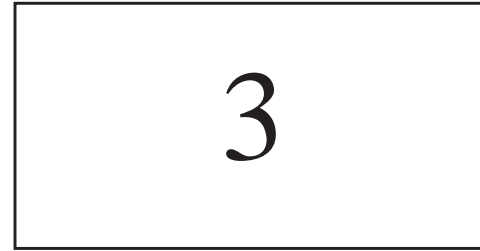
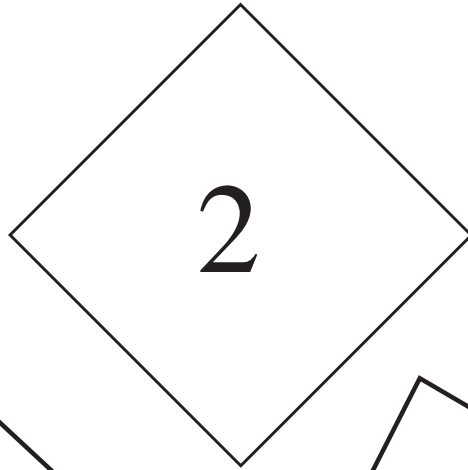
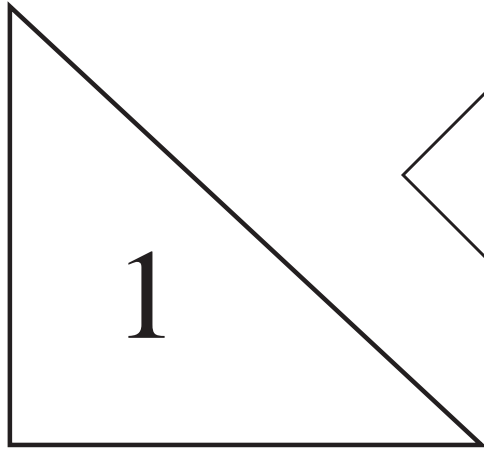

a)

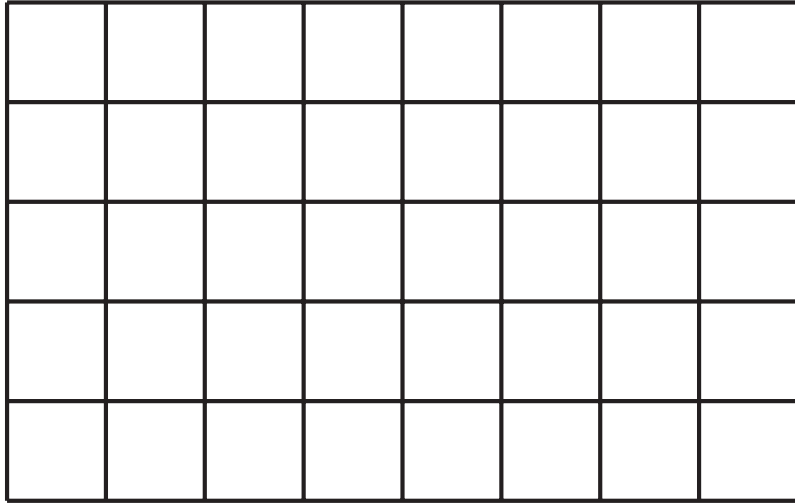

b)

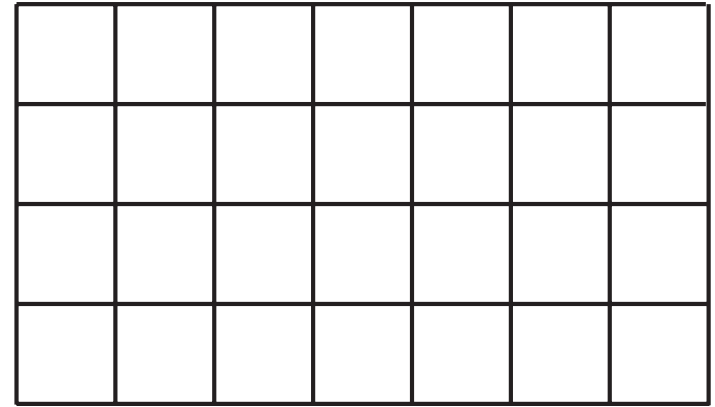

i) $P =$ \longleftarrow units

$A =$ units

$P =$ \longleftarrow units

$A =$ units

ii) $P =$ \longleftarrow units

$A =$ units

$P =$ \longleftarrow units

$A =$ units

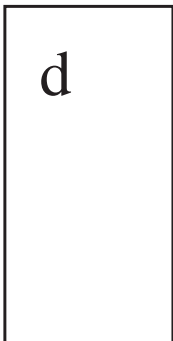
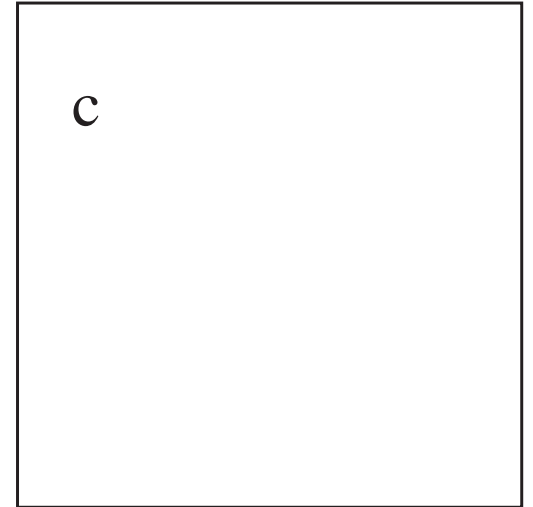
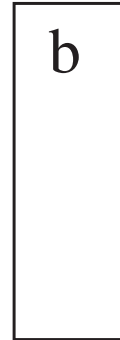
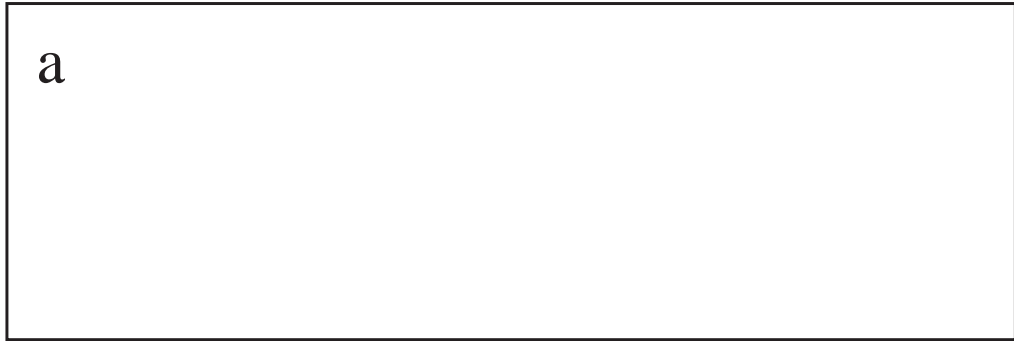

a)

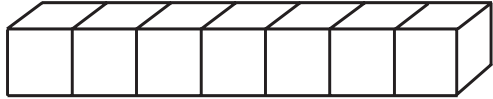

 Volume = unit cubes

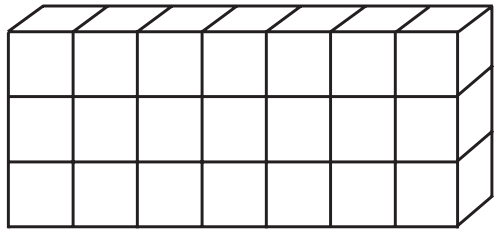
b)

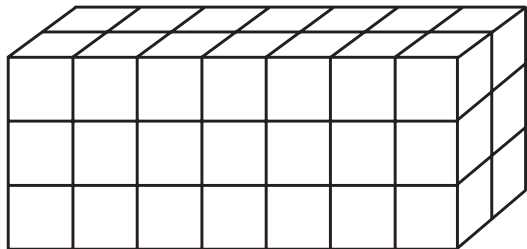

Volume = unit cubes

c)



Volume = unit cubes

a) $1425 \text{ m} = \square \text{ km } \square \text{ m}$

b) $1840 \text{ g} = \square \text{ kg } \square \text{ g}$

$1007 \text{ m} = \square \text{ km } \square \text{ m}$

$1016 \text{ g} = \square \text{ kg } \square \text{ g}$

c) $1618 \text{ mm} = \square \text{ m } \square \text{ mm}$

d) $1276 \text{ ml} = \square \text{ litre } \square \text{ ml}$

$1010 \text{ mm} = \square \text{ m } \square \text{ mm}$

$1042 \text{ ml} = \square \text{ litre } \square \text{ ml}$

e) $1328 \text{ mm} = \square \text{ m } \square \text{ mm} = \square \text{ m } \square \text{ cm } \square \text{ mm}$

$157 \text{ cm} = \square \text{ m } \square \text{ cm} = \square \text{ m } \square \text{ mm}$

$1 \text{ km } 65 \text{ m} = \square \text{ m}$

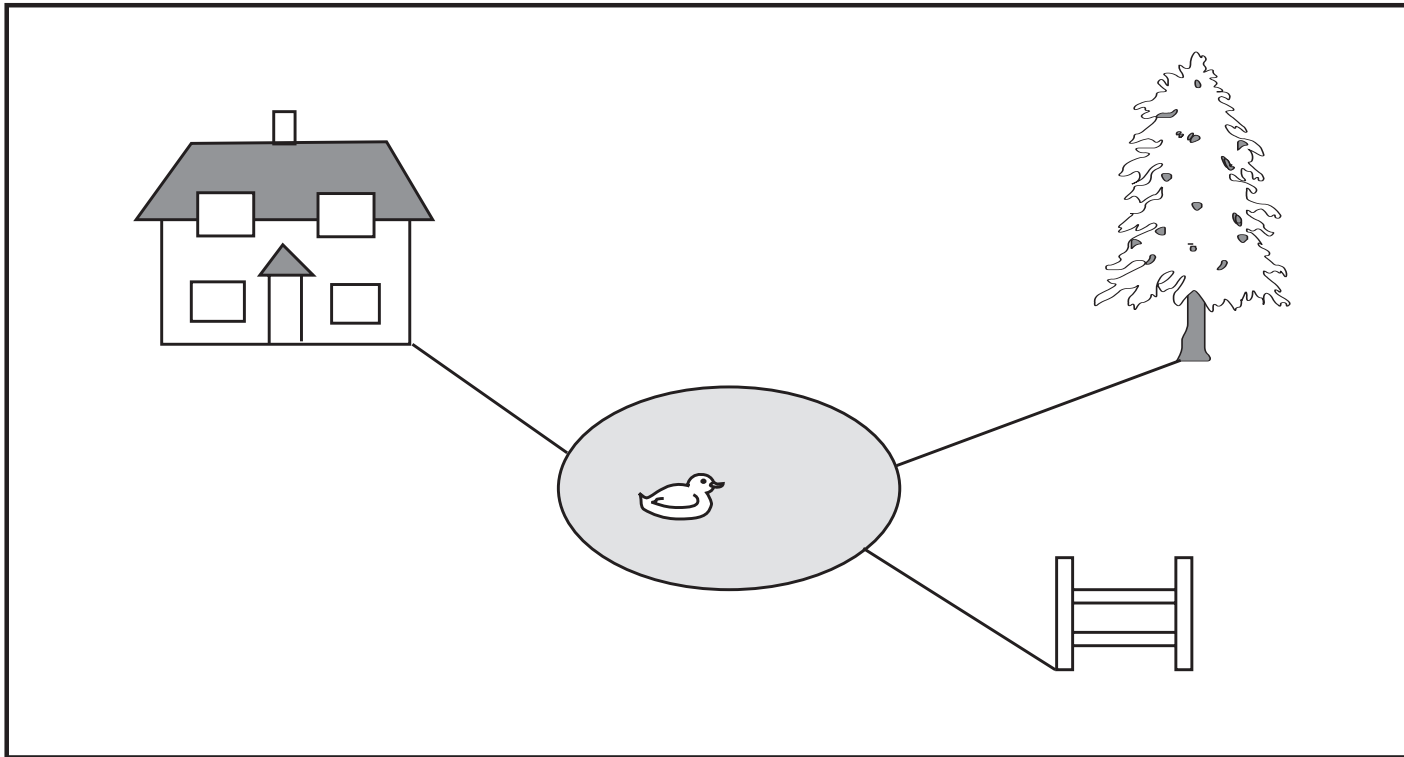

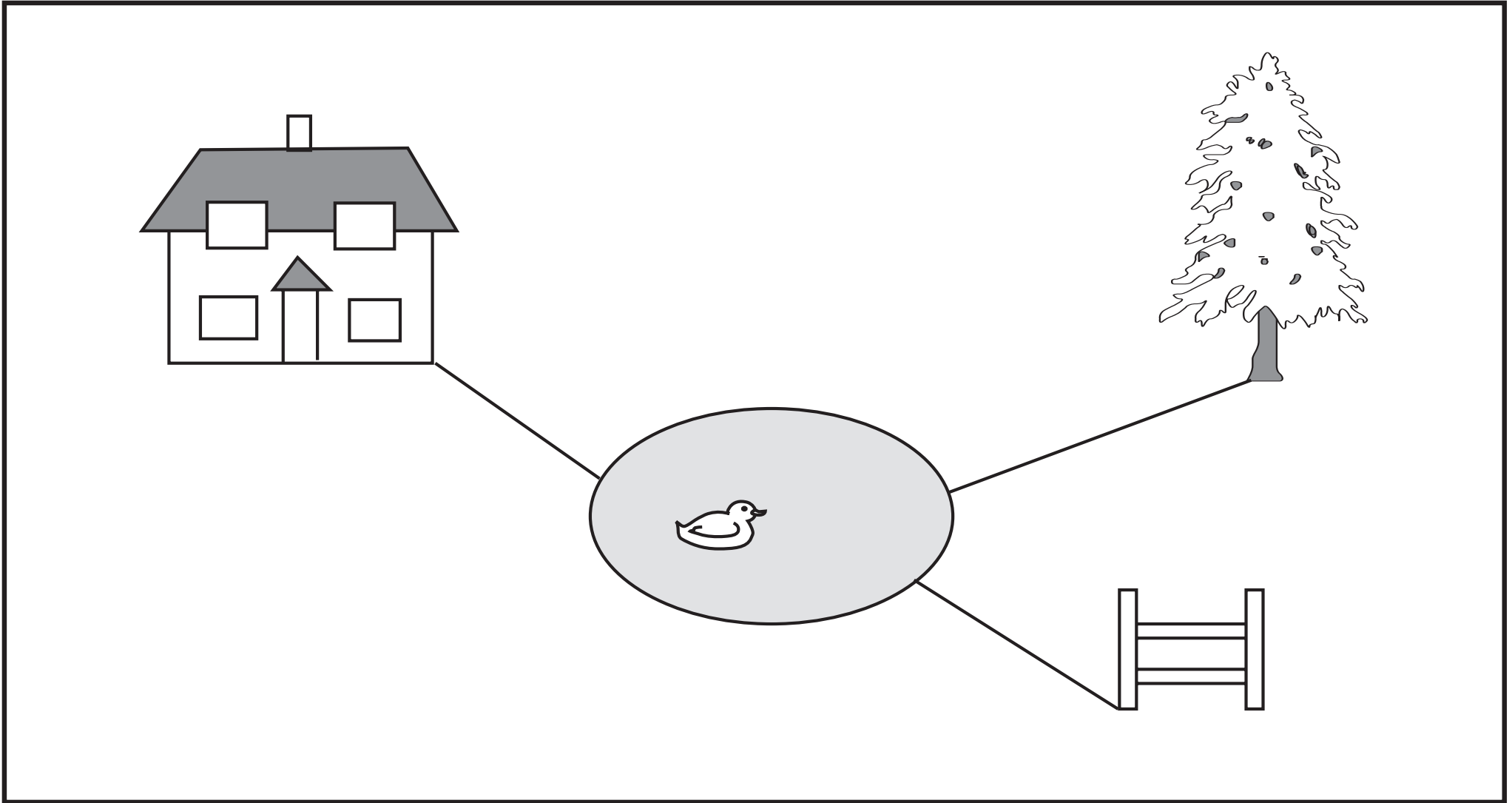

Scale: 1 mm \rightarrow 20 m

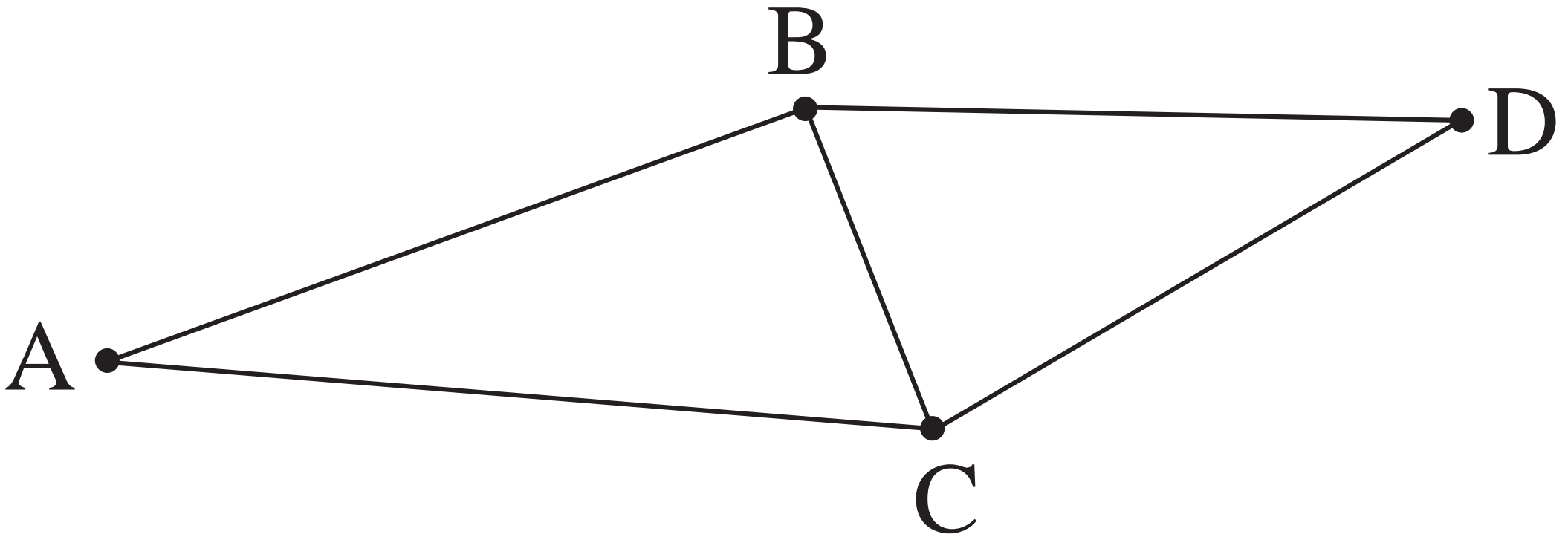

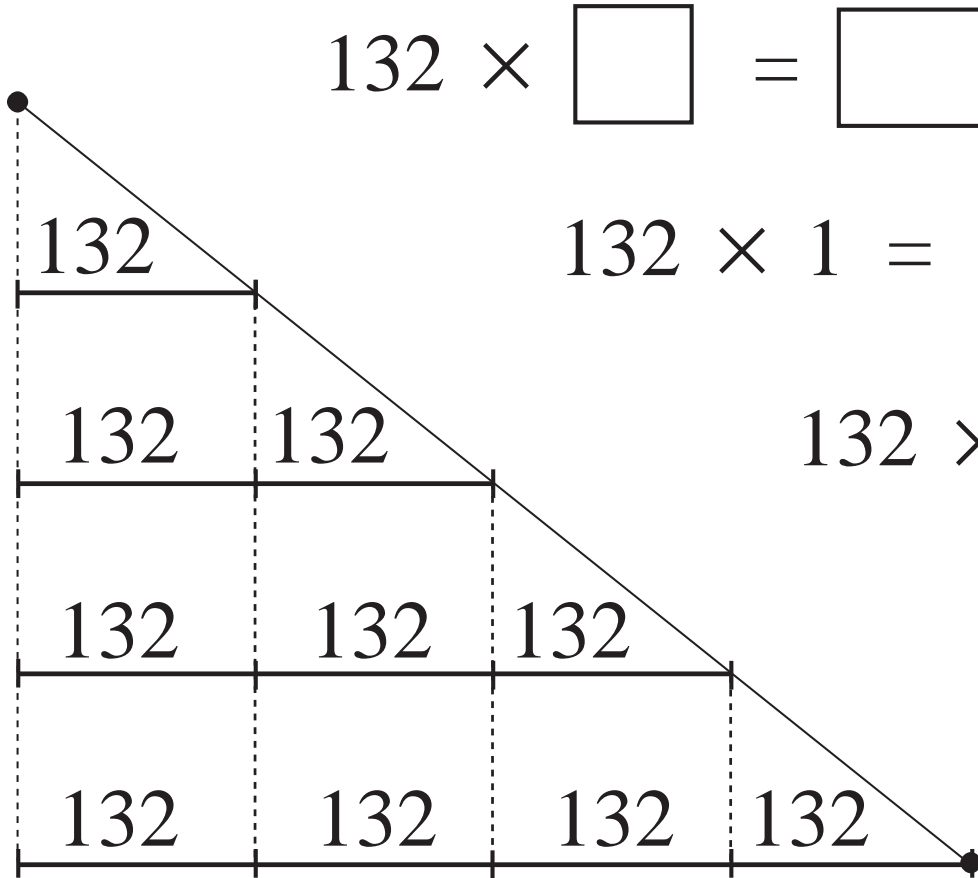

$$132 \times \square = \square$$

$$132 \times 1 = \square$$

$$132 \times 2 = \square$$

$$132 \times 3 = \square$$

$$132 \times 4 = \square$$

1000 g

1235 cm

1027 g

2 kg 4 g

12 m 35 mm

1 kg

1 kg 27 g

12 m 35 cm

348 g

a) 1 third of a year = months 1 quarter of a year = months

1 year 3 months = months of a year = 6 months

1 year = seasons of a year = 8 months

b) 1 quarter of a day = hours 1 eighth of a day = hours

3 days = hours 3 quarters of a day = hours

days = 48 hours of a day = 21 hours

a) year = 4 seasons 1 year = months

1 year = days, or 1 leap year = days

are the years divisible by 4.

Only every 4th whole hundred is a .

The year 2000 was a .

The year 2000 was the year of the 20th century.

The first year of the 21st century is .

The first day of the 21st century is .

Years are counted from the birth date of .

b) 31 day months:

30 day months:

28 or 29 day months:

c) 1 week = days

1 day = hours

1 hour = minutes

1 minute = seconds

1 year = weeks + 1 or 2 days

Time (seconds)	0	10	20	30		50	60			90	100	
Water level (mm)	0	30			120			210	240			330

LP 145/1a

Quantity (kg)	1	6	4	9	5	7	1 and a half
Price (pence)	208						

LP 145/2

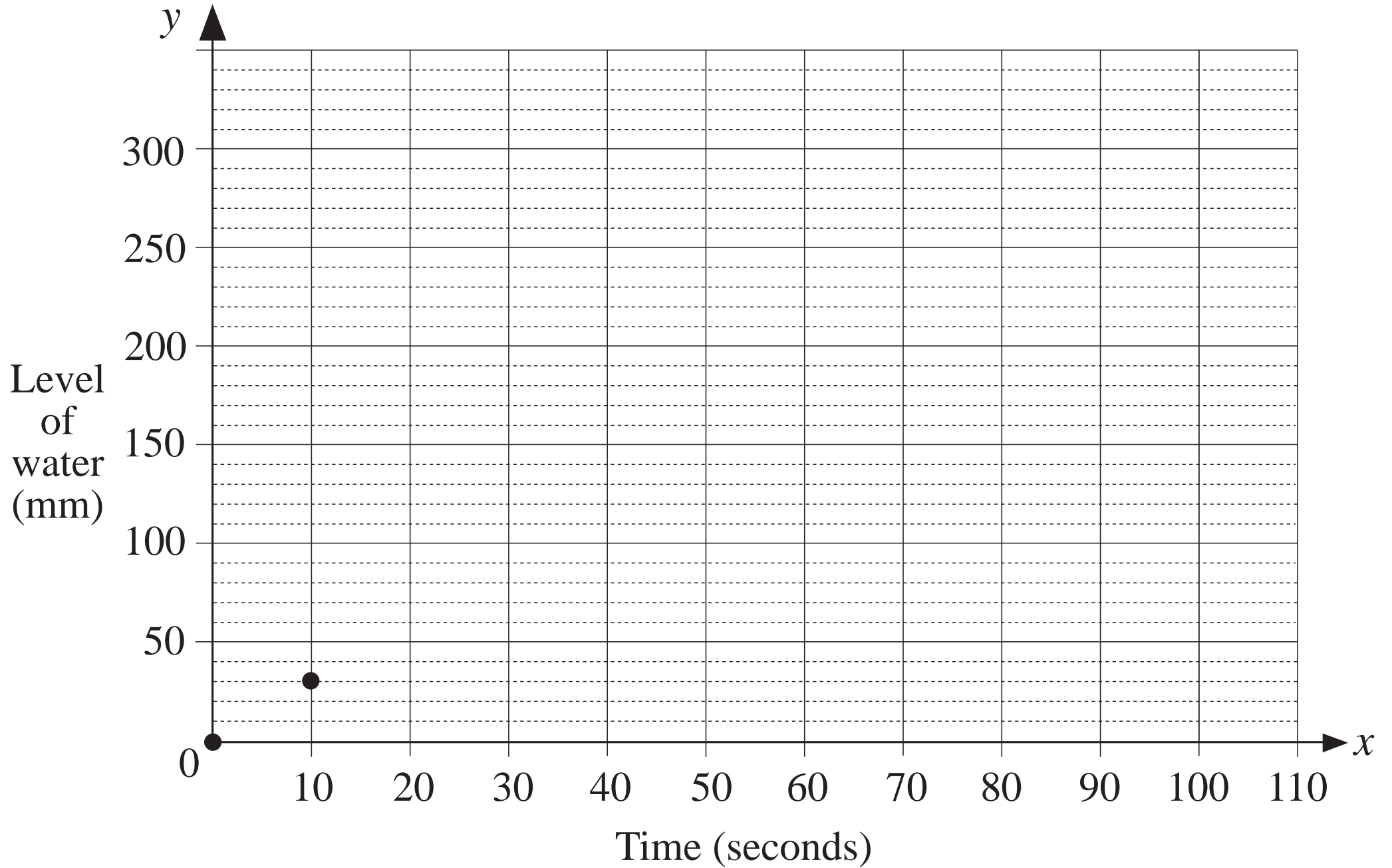

a) $248 \times 4 = 496 \times \square$

b) $74 \times \square = 148 \times 4$

c) $93 \times \square = 279 \times 3$

d) $132 \times 3 = 132 \times 2 + \square$

e) $152 \times 4 = 152 \times 3 + \square$

f) $108 \times 6 = 108 \times 7 - \square$

g) $311 \times 4 = 311 \times 6 - \square$

h) $142 \times 3 = 71 \times 6 + \square$

i) $913 - 378 < \square < 137 \times 4$

.....

j) $524 + 476 \geq \square \geq 250 \times 4$

.....

<i>a</i>	0	1	2	3	4	5	9	13	17	18	20	24
<i>b</i>	0	1	2	0	1	2						

LP 146/5

①	25	70	65	36	105	109	140	280	93	97
⑤	5									
<i>R</i>	0									

LP 147/3



a)

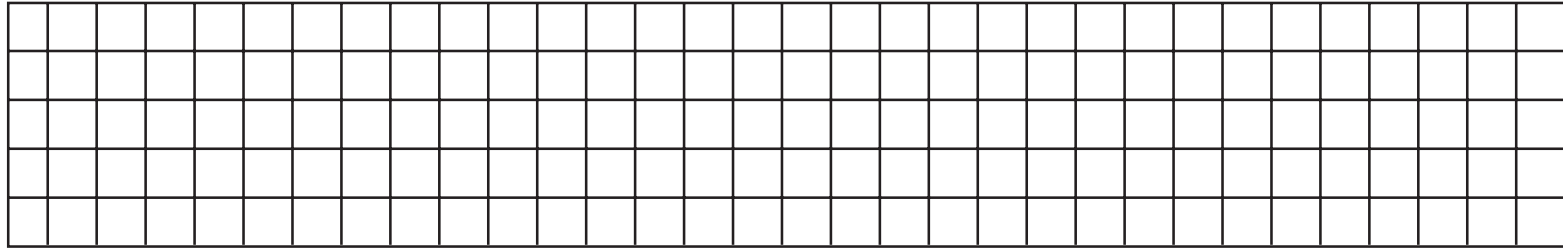

b)

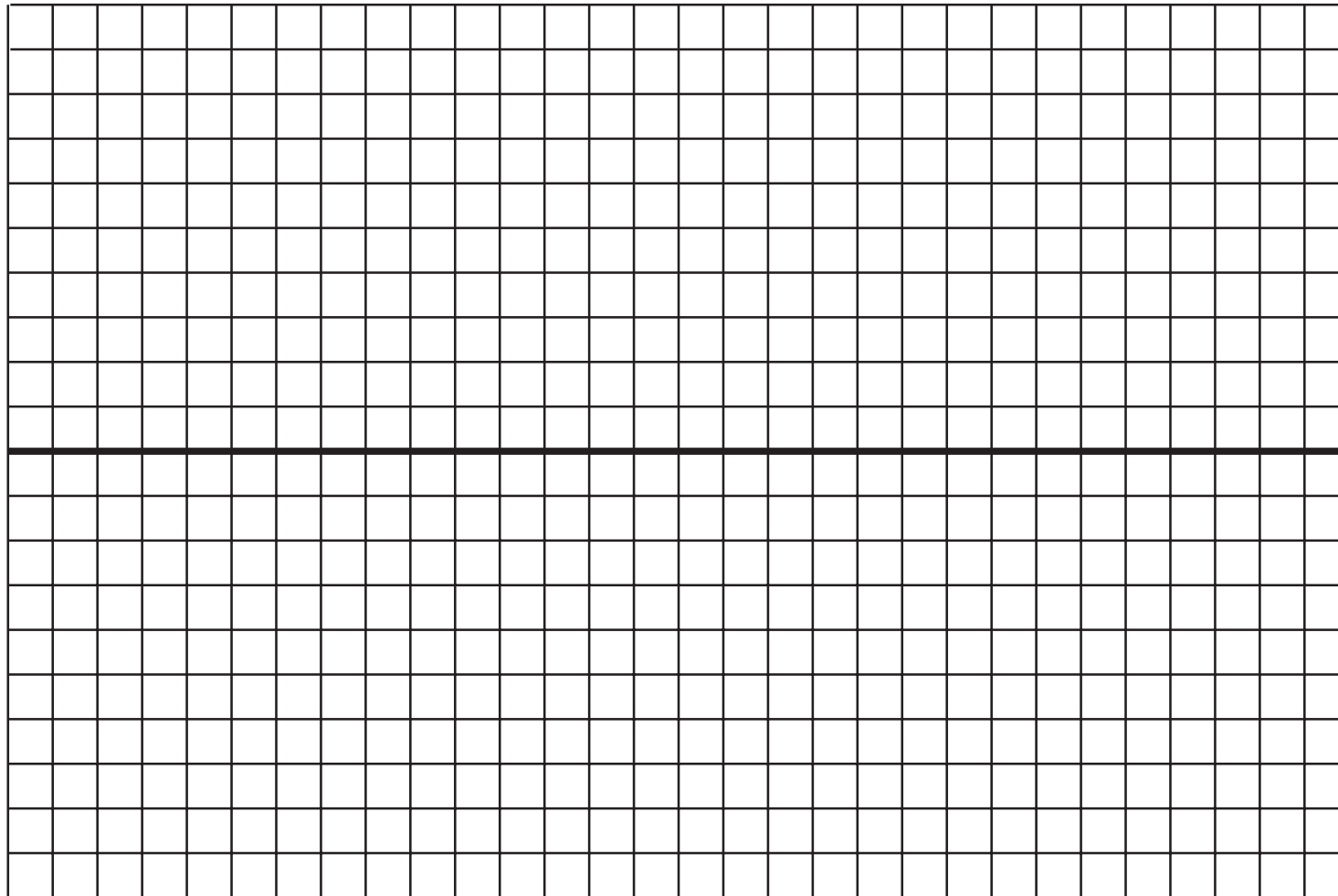

a) i) $\begin{matrix} \textcircled{1} & \textcircled{1} & \textcircled{1} & \textcircled{1} & \textcircled{1} \\ \textcircled{1} & \textcircled{1} & \textcircled{1} & \textcircled{1} & \textcircled{1} \end{matrix}$

.....
.....

ii) $\begin{matrix} \textcircled{10} & \textcircled{10} & \textcircled{10} & \textcircled{10} & \textcircled{10} \\ \textcircled{10} & \textcircled{10} & \textcircled{10} & \textcircled{10} & \textcircled{10} \end{matrix}$

.....
.....

iii) $\begin{matrix} \textcircled{100} & \textcircled{100} & \textcircled{100} & \textcircled{100} & \textcircled{100} \\ \textcircled{100} & \textcircled{100} & \textcircled{100} & \textcircled{100} & \textcircled{100} \end{matrix}$

.....
.....

b) i) $\begin{matrix} \textcircled{5} & \textcircled{5} & \textcircled{5} & \textcircled{5} & \textcircled{5} \\ \textcircled{5} & \textcircled{5} & \textcircled{5} & \textcircled{5} & \textcircled{5} \end{matrix}$

.....
.....

ii) $\begin{matrix} \textcircled{50} & \textcircled{50} & \textcircled{50} & \textcircled{50} & \textcircled{50} \\ \textcircled{50} & \textcircled{50} & \textcircled{50} & \textcircled{50} & \textcircled{50} \end{matrix}$

.....
.....

iii) $\begin{matrix} \textcircled{200} & \textcircled{200} & \textcircled{200} & \textcircled{200} & \textcircled{200} \\ \textcircled{200} & \textcircled{200} & \textcircled{200} & \textcircled{200} & \textcircled{200} \end{matrix}$

.....
.....

$$\text{a) } 102 \times 6 = 102 \times 3 + \boxed{} \quad 102 \times 6 = 102 \times 3 + \boxed{}$$

$$\text{b) } 116 \times 3 < 116 \times \boxed{} \quad 109 \times 2 < \boxed{} \times 2$$

$\times 2$ $\times 4$

$$\text{c) } 128 \times 2 < 128 \times \boxed{} \quad 151 \times 4 > 151 \times \boxed{}$$

128 151

$$\text{d) } 158 \times 5 - \boxed{} = 450 \div 5 + 699$$

$$\text{e) } 676 + 487 \leq \boxed{} - 126 \leq 233 \times 5$$

0, 5, 8, 9, 12, 16, 17, 27, 40, 44, 45,
72, 80, 81, 90, 96

a)

Divisible by 8	Not divisible by 8

b)

Multiples of 9	Not multiples of 9

3, 9, 8, 1, 36, 12, 4, 6, 18, 11, 2, 5, 10, 53, 72, 0

Divisor of 36	Not a divisor of 36

n	d
1	1
2	1, 2
3	1, 3
4	1, 2, 4
5	1, 5
6	
7	
8	
9	
10	
11	
12	
13	
14	
15	

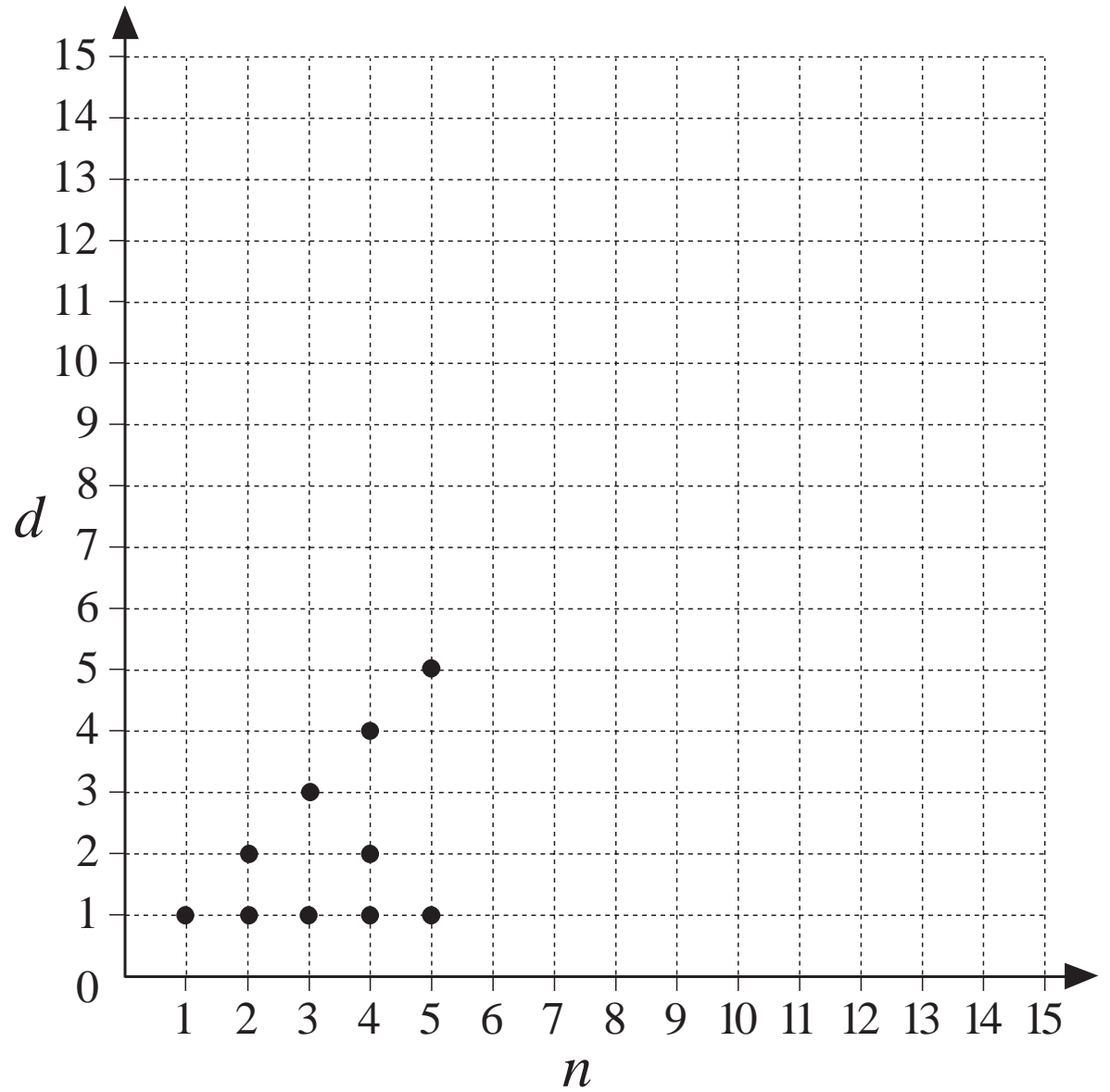

a)

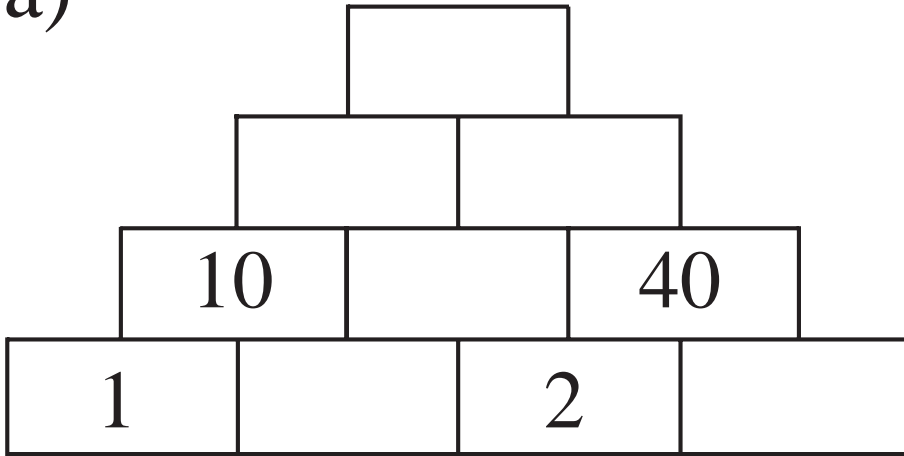

b)

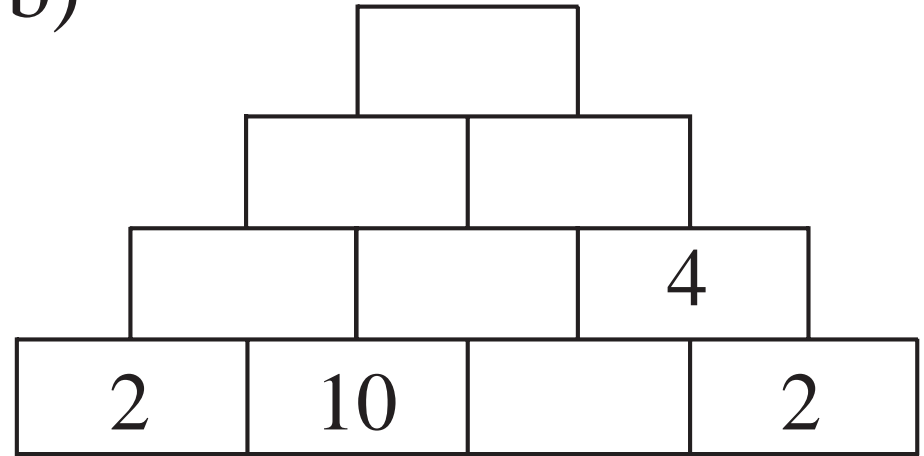

c)

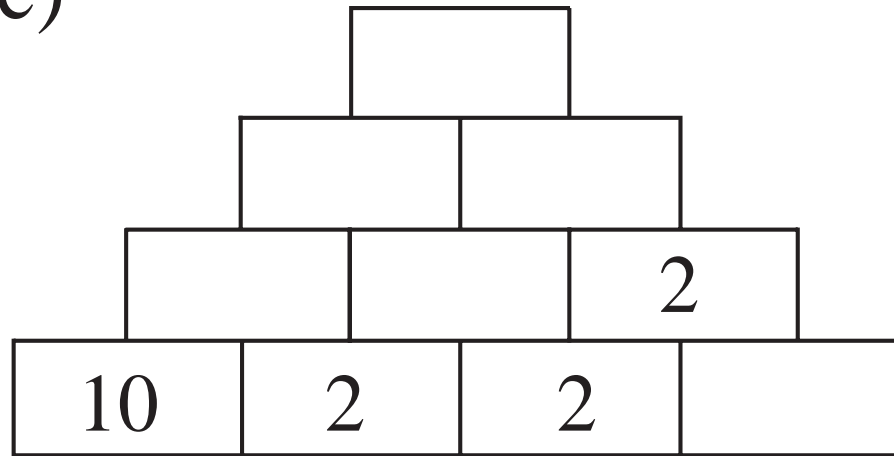

a)

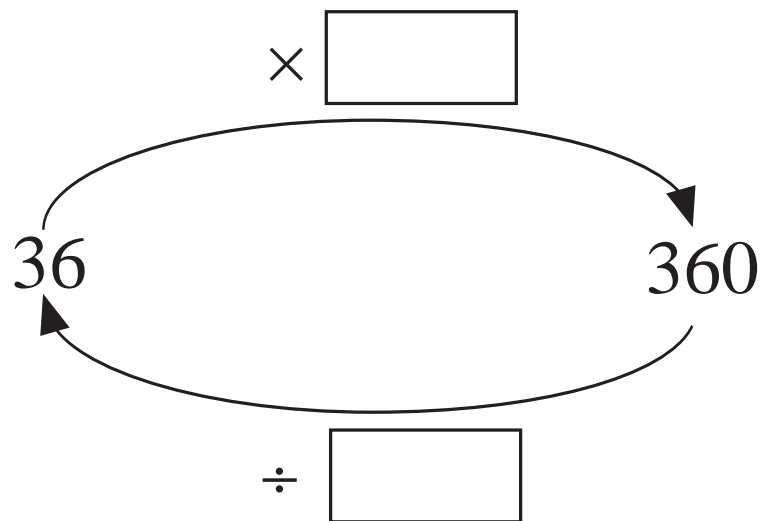

b)

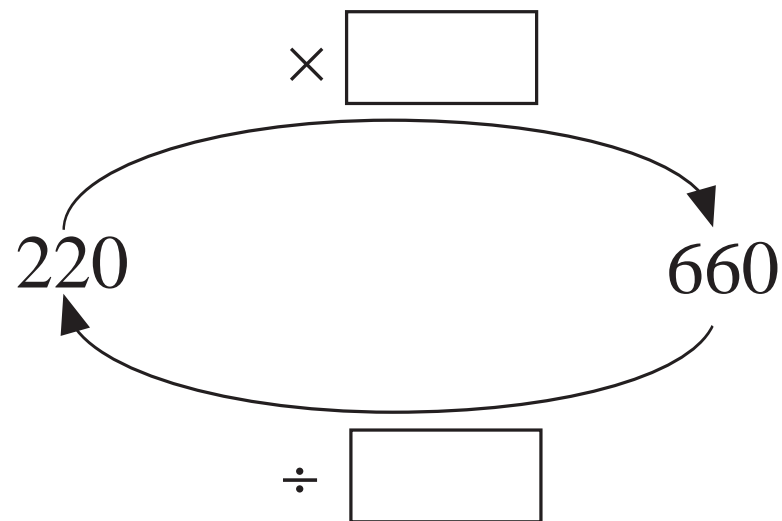

c)

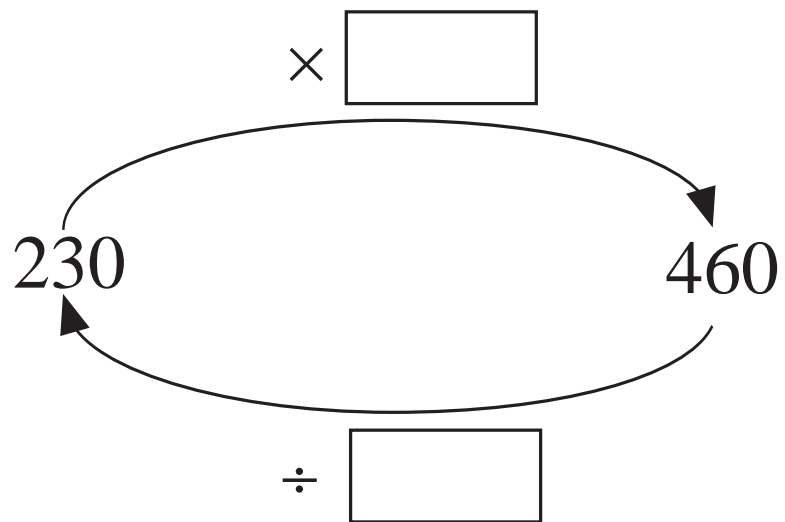

d)

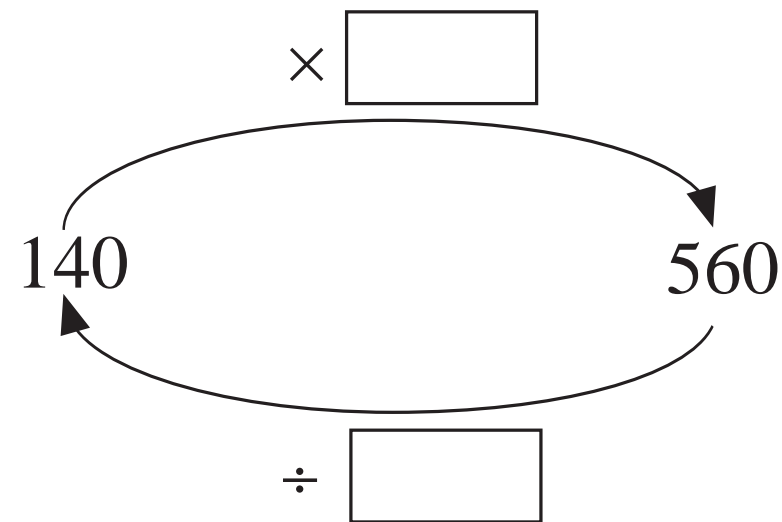



a) $220 \div 2 = 100$

b) $540 \div 9 = 70$

c) $480 \div 4 = 120$

d) $426 \div 6 = 71$

e) $270 \div 3 = 900$

f) $567 \div 7 = 8$

Remainder after dividing by 7

0	1	2	3	4	5	6

Remainder

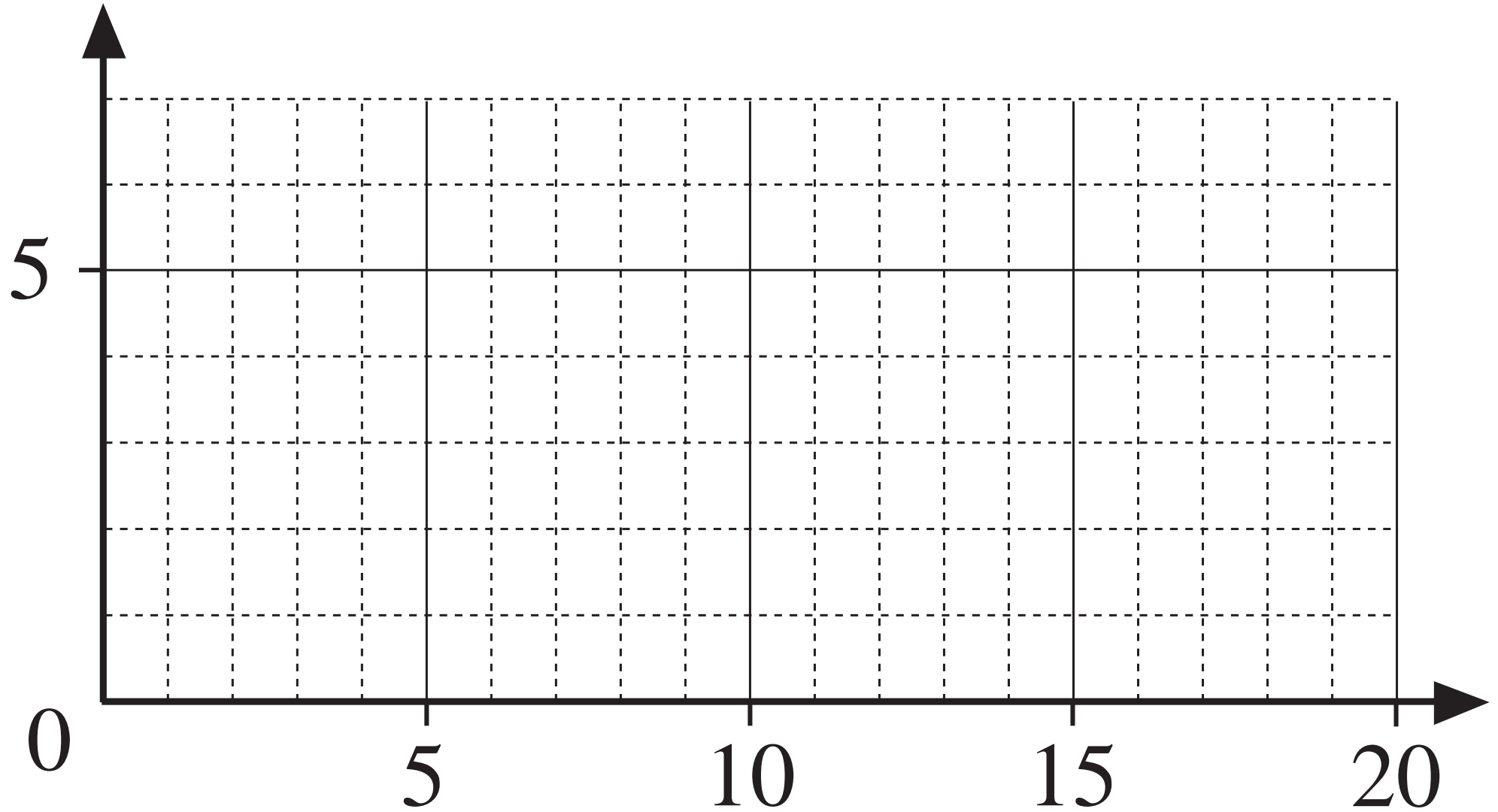

Numbers 0 to 20

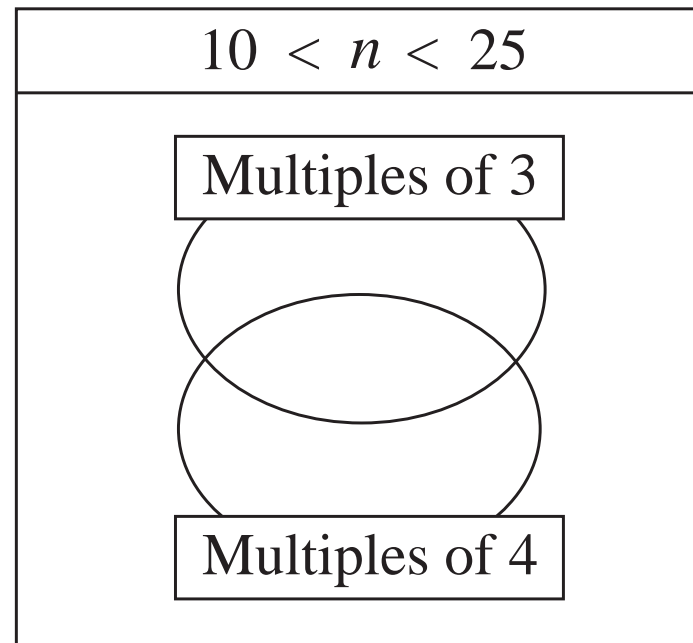
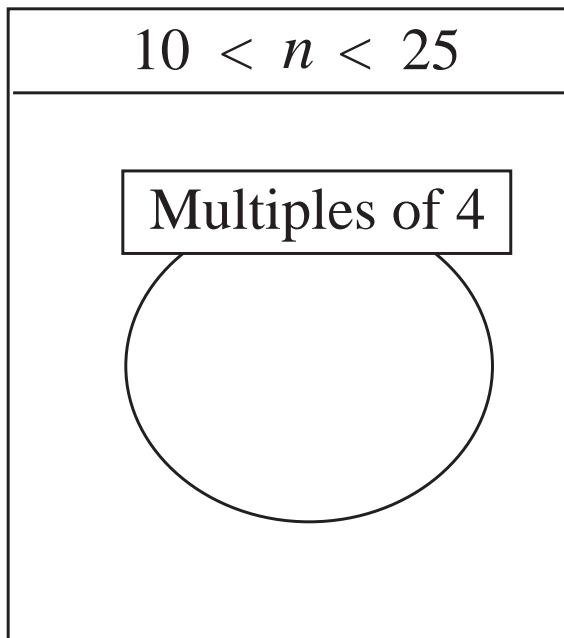
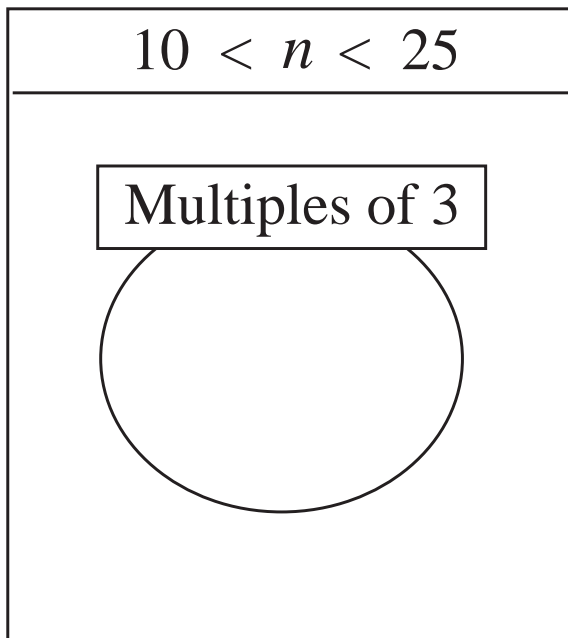

LP 148/9

100	100	100	100	100	100	100	100	100
10	10	10	10	10	10			
1	1	1	1	1	1	1	1	1

LP 149/4

H	T	U
9	6	9
9	↓	↓
0	6	
	6	↓
	0	9
		9
		0

$\div 3 =$

H	T	U
3	2	3

← $3H \times 3$

← $2T \times 3$

← $3U \times 3$

9	6	9	÷	3	=	3	2	3
9								
0	6							
	6							
	0	9						
		9						
		0						

	3	2	3
3	9	6	9
-	9		
	0	6	
-		6	
		0	9
	-		9
			0

H	T	U
9	6	9

$\div 3 =$

H	T	U

9	6	9	\div	3	=						

3	9	6	9

a) $840 \div 4 = 800 \div 4 + \boxed{} \div 4 = \boxed{} + \boxed{} = \boxed{}$

$630 \div 3 = \boxed{} \div 3 + 30 \div 3 = \boxed{} + \boxed{} = \boxed{}$

b) $650 \div 5 = 500 \div 5 + \boxed{} \div 5 = \boxed{} + \boxed{} = \boxed{}$

$768 \div 4 = 400 \div 4 + \boxed{} \div 4 + 8 \div 4$
 $= \boxed{} + \boxed{} + \boxed{} = \boxed{}$

c) $840 \div 6 = 600 \div 6 + \boxed{} \div 6 = \boxed{} + \boxed{} = \boxed{}$

$459 \div 3 = 300 \div 3 + \boxed{} \div 3 + 9 \div 3$
 $= \boxed{} + \boxed{} + \boxed{} = \boxed{}$

d) $910 \div 7 = \boxed{} \div 7 + 210 \div 7 = \boxed{} + \boxed{} = \boxed{}$

$960 \div 8 = \boxed{} \div 8 + 160 \div 8 = \boxed{} + \boxed{} = \boxed{}$

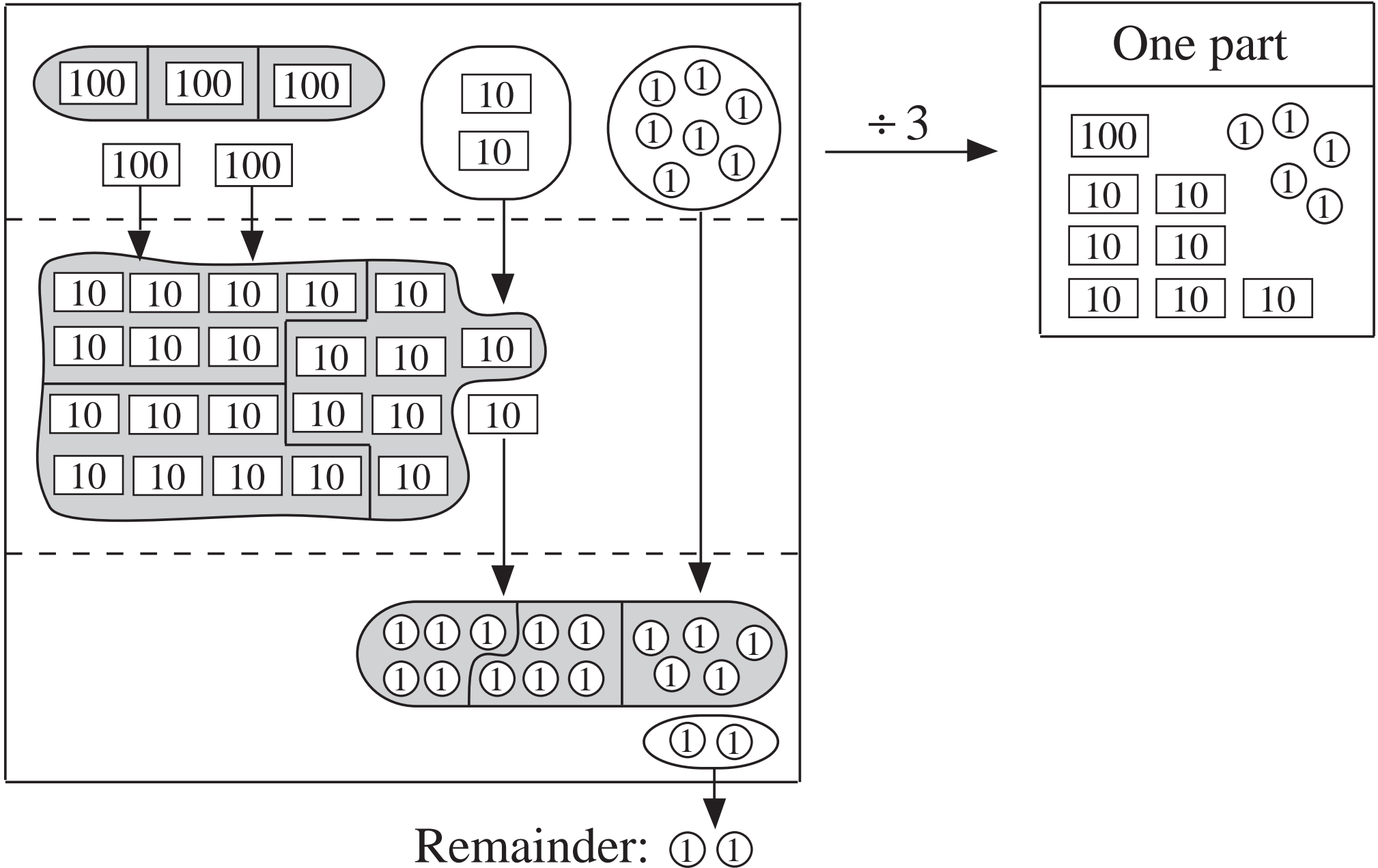

H	T	U
5	2	7
3	↓	↓
2	2	
2	1	
	1	7
	1	5
		2

$\div 3 =$

H	T	U
1	7	5

← (1H × 3)

← (7T × 3)

← (5U × 3)

	5	2	7	÷	3	=	1	7	5
–	3								
	2	2							
–	2	1							
		1	7						
–		1	5						
			2						

	1	7	5
3	5	2	7
–	3		
	2	2	
–	2	1	
		1	7
	–	1	5
			2

3	5	2	7				
—		3	0	1	0		
	4	9	7				
—	3	0	0	1	0	0	
	1	9	7				
—	1	8	0	6	0		
		1	7				
	—	1	2			4	
			5				
		—	3			1	
			②	1	7	5	r 2

	Divisible by 5	Not divisible by 5
Divisible by 2		
Not divisible by 2		



	0 6 12 18 24 30	2 4 8 10 14 16 20 22 26 28
	3 9 15 21 27	1 5 7 11 13 19 23 25 29

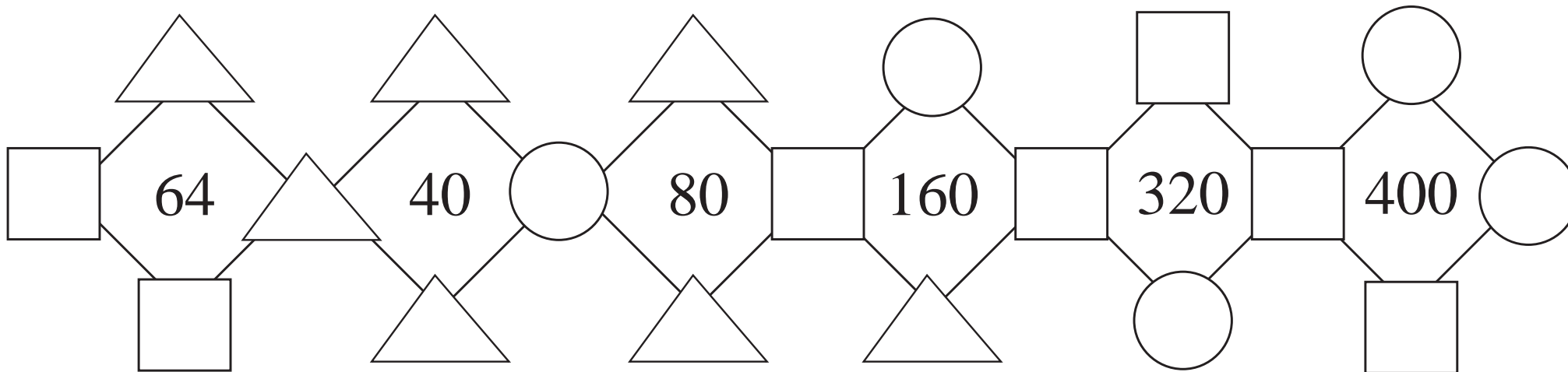

LP 151/2

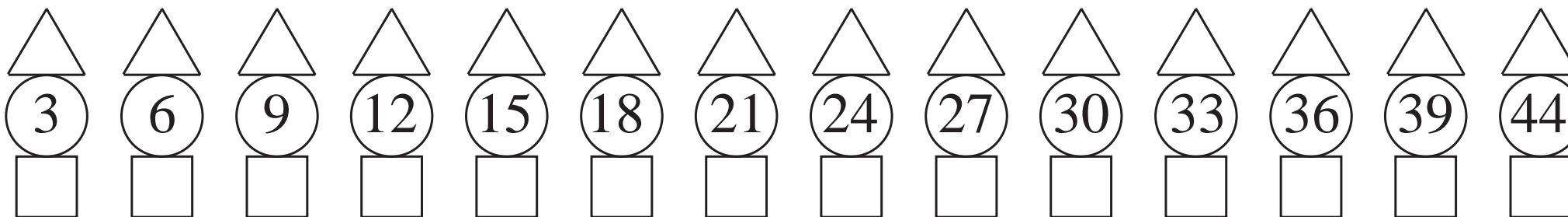

a) Answer: 15, r 2

	1	5
3	3	1
-	3	7
	0	1
	-	1
		5
		2

	3	3
	1	1
	7	

b) Answer: 24, r 3



	2	4	0
4	9	6	3
-	8		
	1	6	
-	1	6	
		0	3

	4	9	6
	3		

c) Answer: 1314

	1	3	1	4
4	5	7	6	
-	4			
	1	7		
-	1	2		
		5		
	-	4		
		1	6	
	-	1	6	
				0

	4	5	7	6

Number of 	264			453	360	531		
Number of 		27	49				69	54

LP 151/6

Total amount	501	374	895	764					Dividend
Number of people	5	3	7	4	6	9	8	2	Divisor
Amount each	100				128	110	123	376	Quotient
Amount remaining	1				3	5	0	1	Remainder

LP 151/8

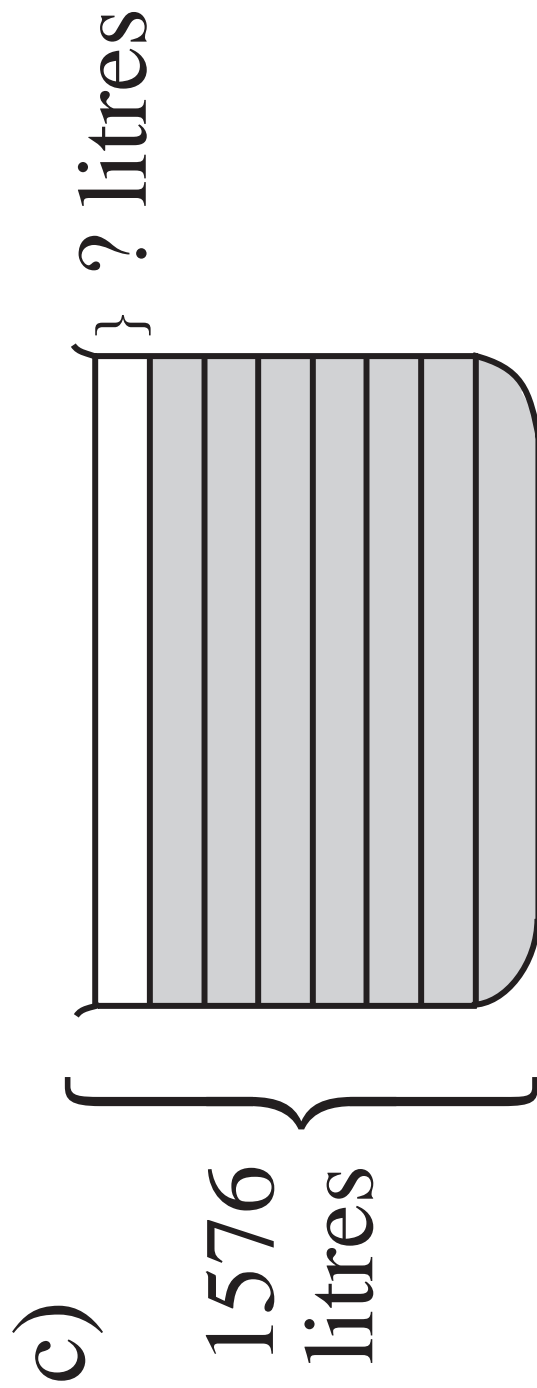
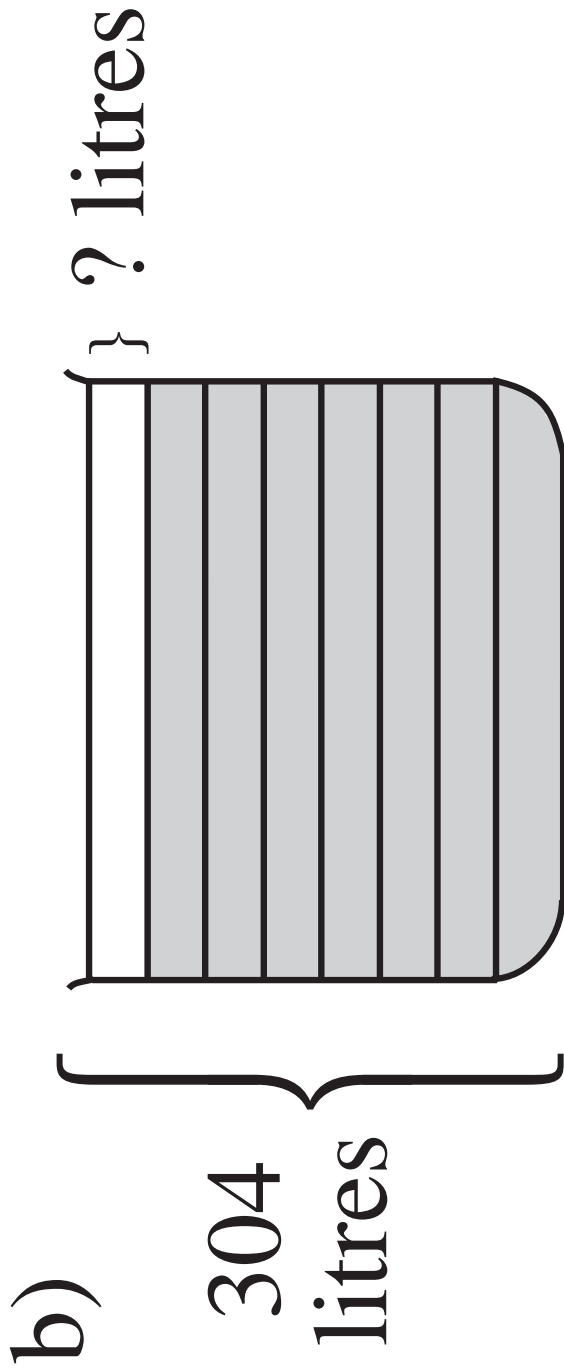
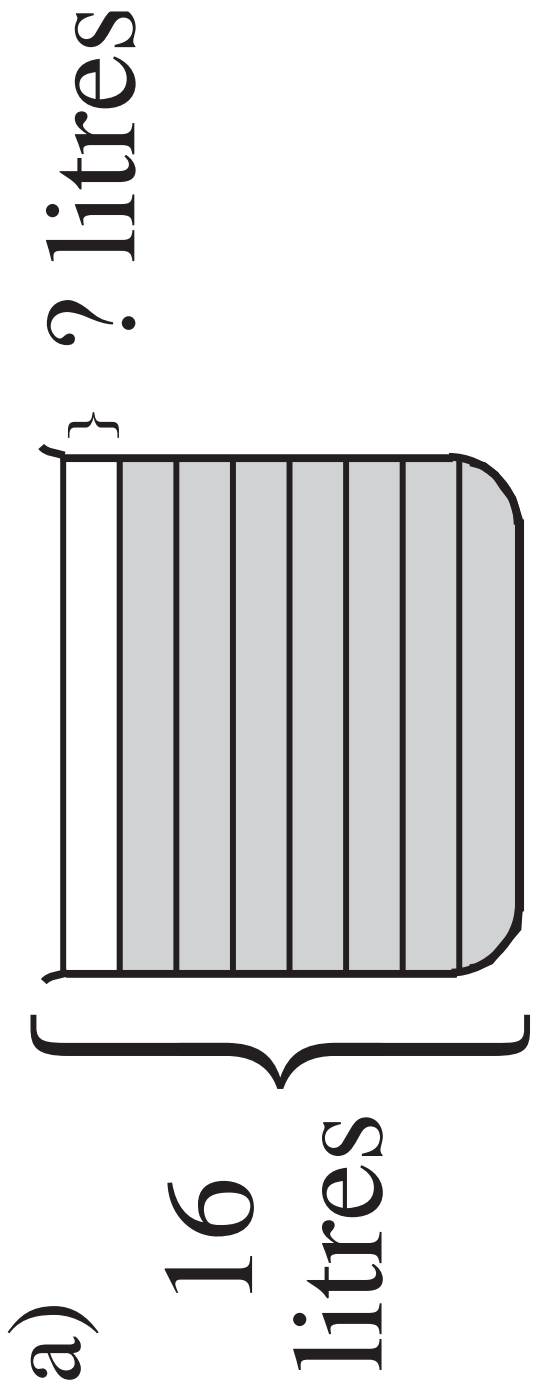

a)

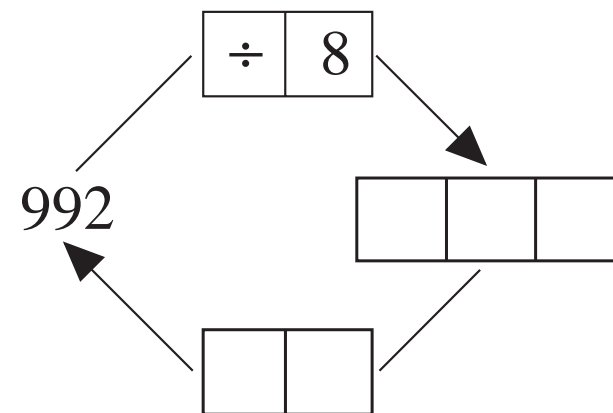
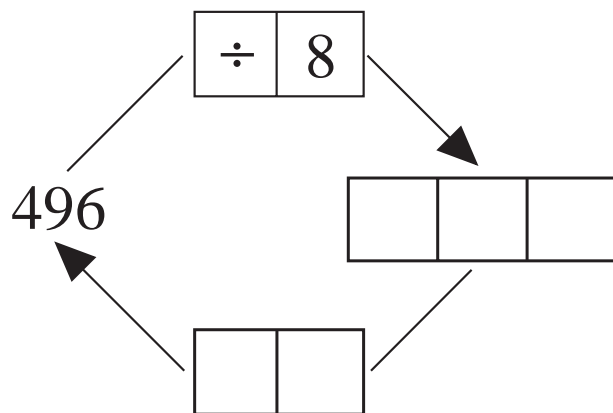
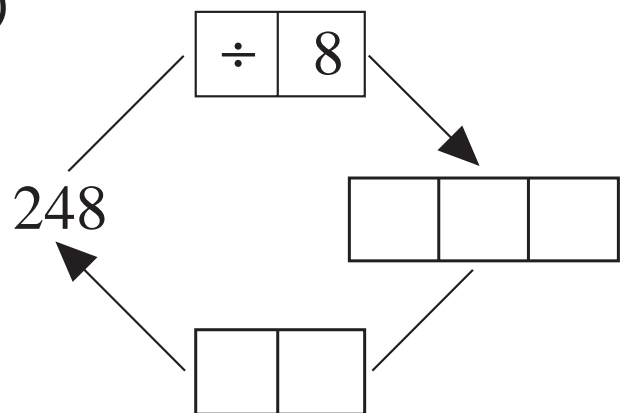

b)

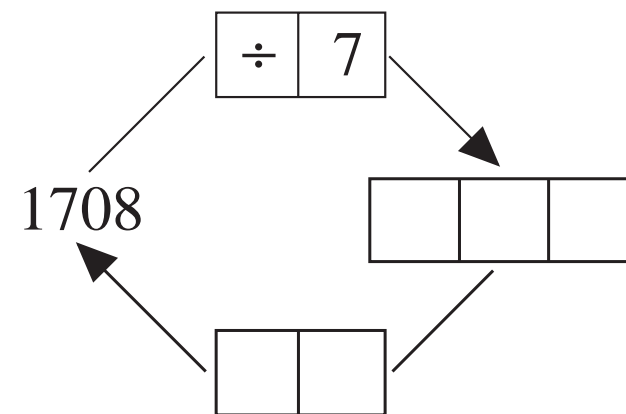
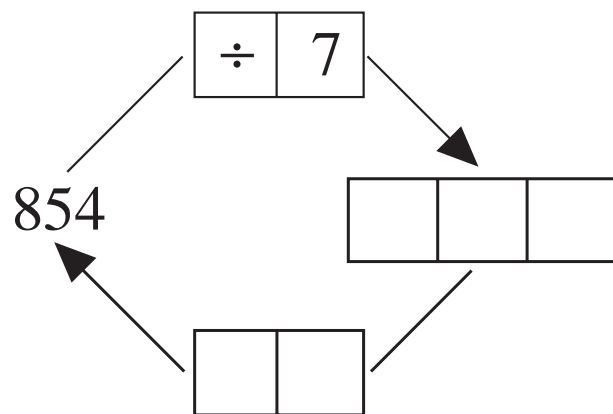
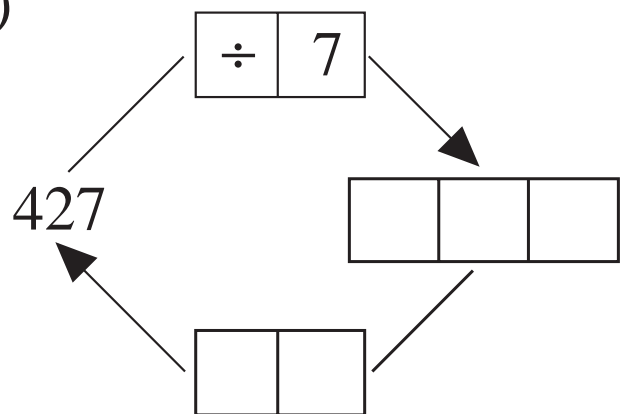

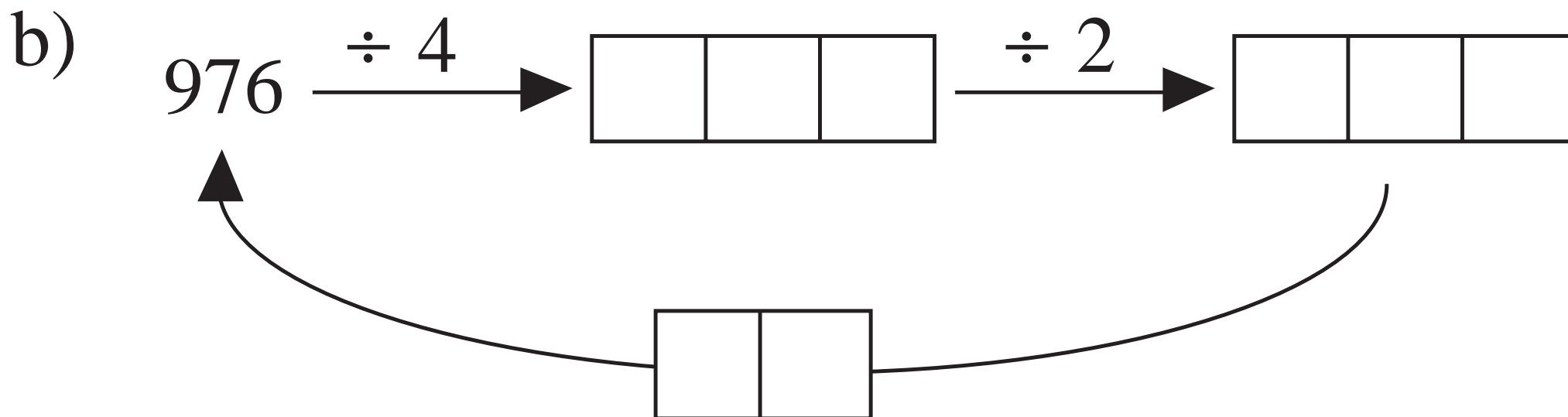
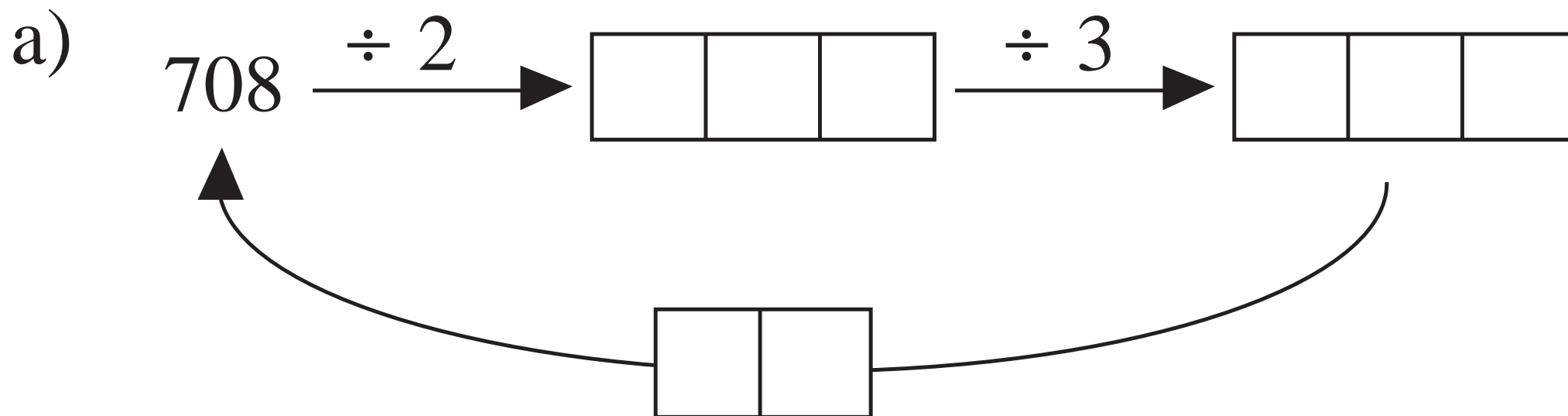

a) $624 \div 8 - 6 = \dots\dots\dots$

$624 \div (8 - 6) = \dots\dots\dots$

$624 \div 6 - 8 = \dots\dots\dots$

b) $116 \div 8 \div 4 = \dots\dots\dots$

$116 \div (8 \div 4) = \dots\dots\dots$

$116 \div 4 \div 8 = \dots\dots\dots$

c) $1600 \div 8 \div 2 = \dots\dots\dots$

$1600 \div (8 \div 2) = \dots\dots\dots$

$1600 \div 2 \div 8 = \dots\dots\dots$

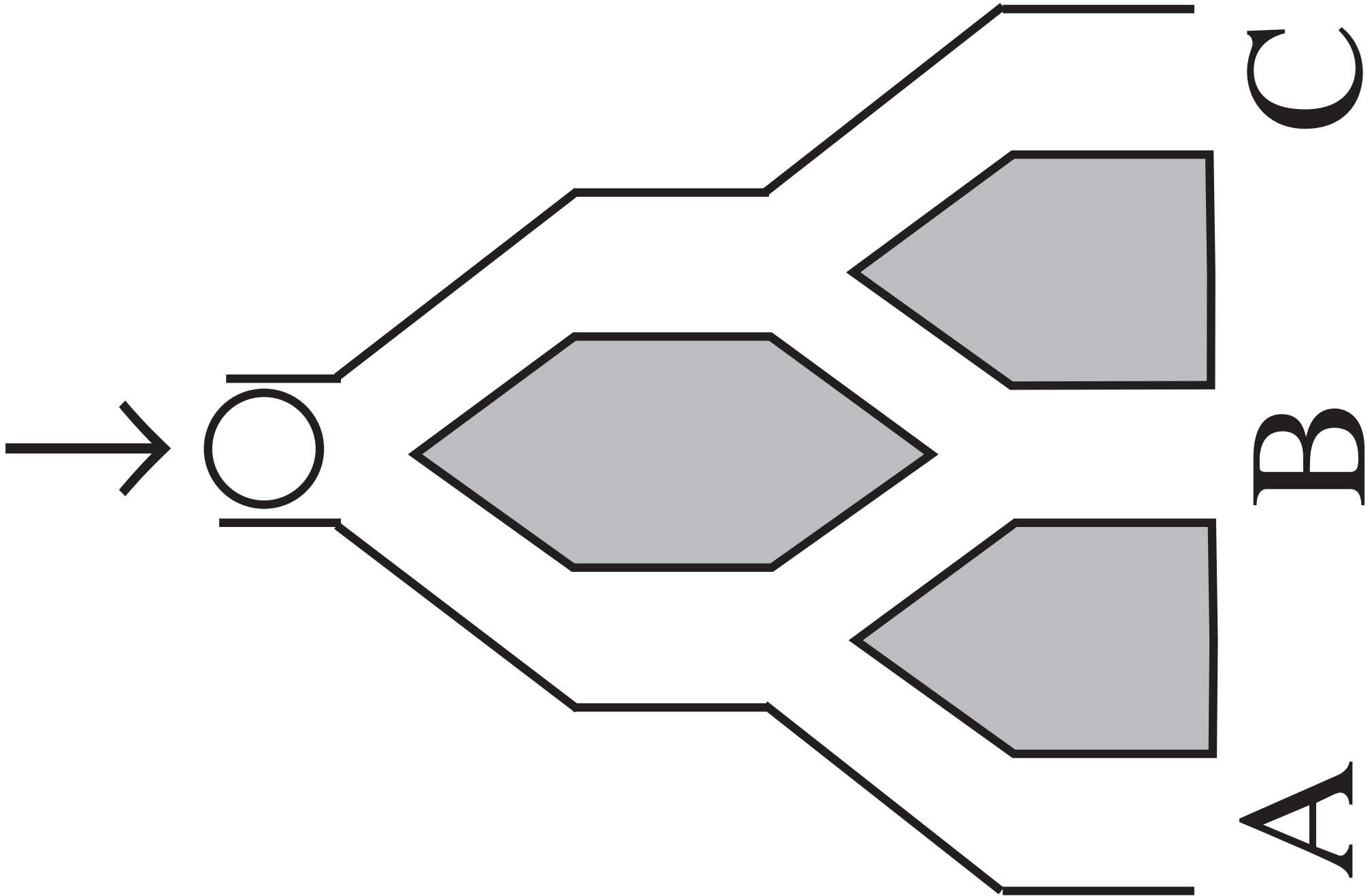

Tally of 20 drops

Totals

A		
B		
C		



Tosses

**Pupil
Total**

**Class
Total**

1 2 3 4 5 6 7 8 9 10 11 12 13 14 15

£1	<i>Head</i>																		
	<i>Tail</i>																		
£2	<i>Head</i>																		
	<i>Tail</i>																		
Number of tosses																			



Pairs' results

Class Total

£1	<i>Head</i>																	
	<i>Tail</i>																	
£2	<i>Head</i>																	
	<i>Tail</i>																	
Number of tosses																		

£1	£2	Pupil Total	Class Total
Head	and Head		
Head	and Tail		
Tail	and Head		
Tail	and Tail		
Number of tosses			



£1	£2	Pairs' results														Class Total	
Head and Head																	
Head and Tail																	
Tail and Head																	
Tail and Tail																	
																Number of tosses	

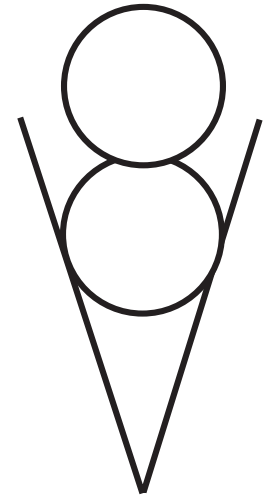
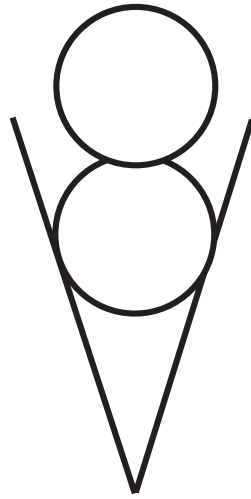
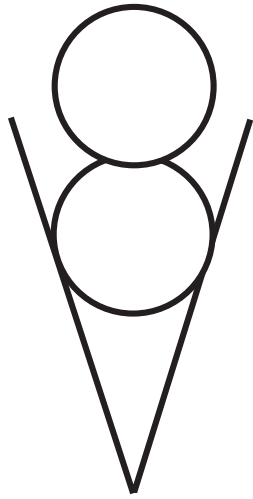
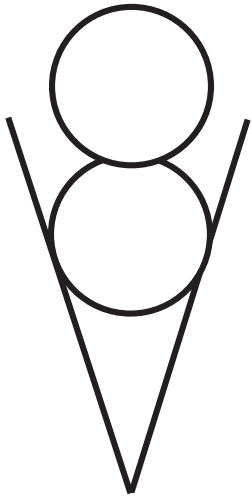

LP 153/7

a) $976 \div 2 =$



b) $976 \div 4 =$



c) $976 \div 8 =$





LP 154/2

a) $1664 \div 4 =$ 

b) $832 \div 4 =$ 

c) $416 \div 4 =$ 

d) $208 \div 4 =$ 

e) $104 \div 4 =$ 

a) $624 \div 4 + 356 =$

$624 + 356 \div 4 =$

$(624 + 356) \div 4 =$

b) $624 - 372 \div 4 =$

$(624 - 372) \div 4 =$

$624 \div 4 - 372 \div 4 =$

c) $372 + 591 \div 3 =$







$(372 + 591) \div 3 =$

$372 \div 3 + 591 \div 3 =$

Tally of 20 throws







Pupil Totals

Class Totals

Pair data

Class Totals

																
																
																
																
																
																
Total number of throws																

3	1	1	2	3	4	5	6
3	2						
3	3						
3	4						
3	5						
3	6						

2	1	1	2	3	4	5	6
2	2						
2	3						
2	4						
2	5						
2	6						

1	1	1	2	3	4	5	6
1	2						
1	3						
1	4						
1	5						
1	6						

6	1	1	2	3	4	5	6
6	2						
6	3						
6	4						
6	5						
6	6						

5	1	1	2	3	4	5	6
5	2						
5	3						
5	4						
5	5						
5	6						

4	1	1	2	3	4	5	6
4	2						
4	3						
4	4						
4	5						
4	6						

Sum of both dice	1	2	3	4	5	6	7	8	9	10	11	12	13
Number of cases													

LP 154/5b

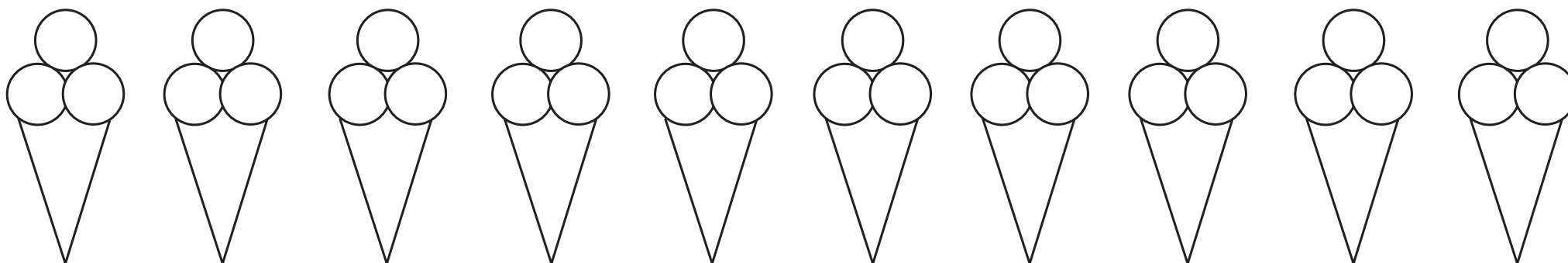

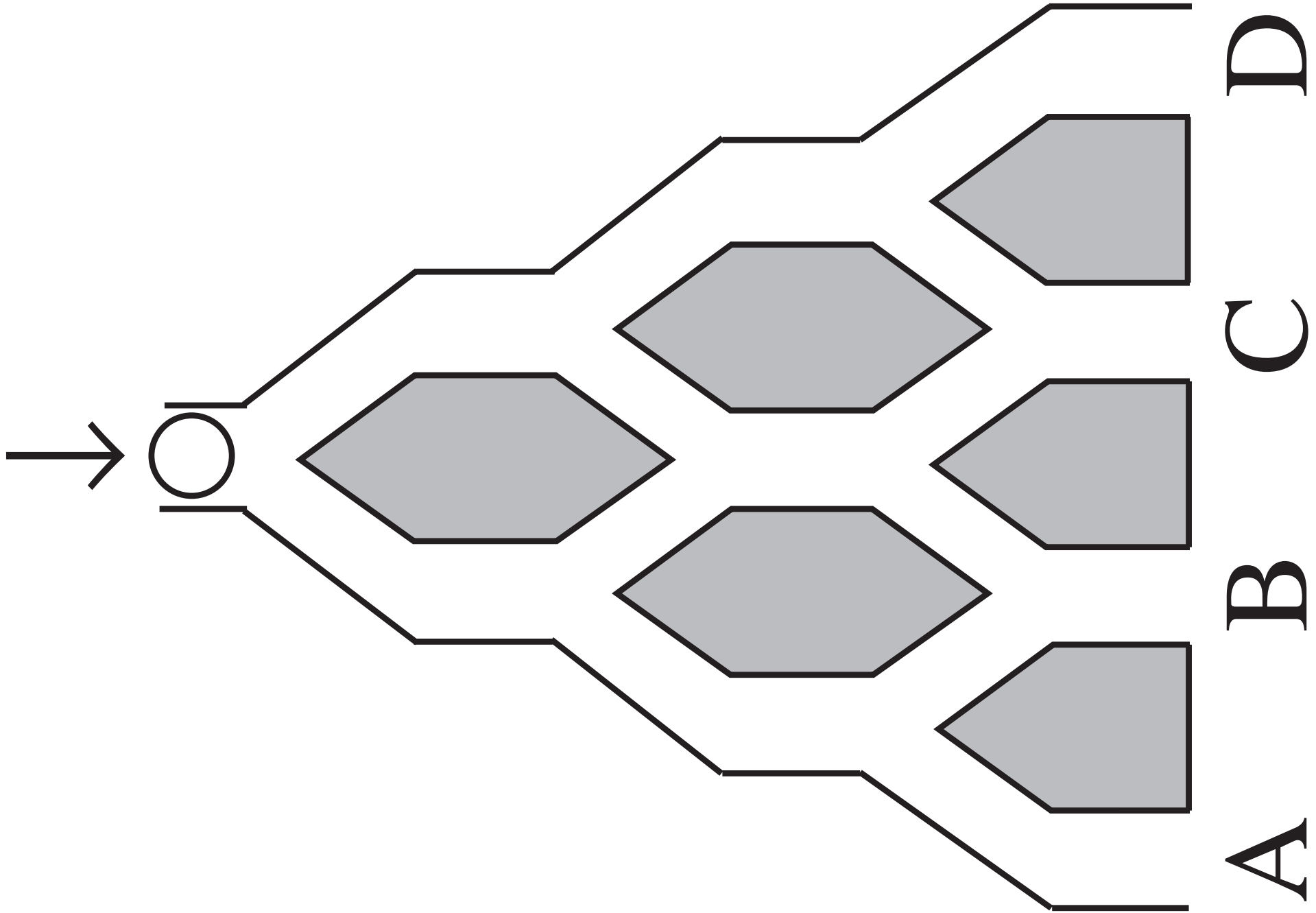

LP 154/6



A B C D

a) $856 \div 8 = \square$ 

b) $428 \div 4 = \square$ 

c) $214 \div 2 = \square$ 

a) $864 \div 2 =$ 

b) $432 \div 4 =$ 

c) $216 \div 8 =$ 

$$1872 \xrightarrow{\div 2} \boxed{} \xrightarrow{\div 3} \boxed{} \xrightarrow{\div 4} \boxed{} \xrightarrow{\div 6} \boxed{}$$

$$1872 \xrightarrow{\div 3} \boxed{} \xrightarrow{\div 4} \boxed{} \xrightarrow{\div 6} \boxed{} \xrightarrow{\div 2} \boxed{}$$

$$1872 \xrightarrow{\div 4} \boxed{} \xrightarrow{\div 6} \boxed{} \xrightarrow{\div 2} \boxed{} \xrightarrow{\div 3} \boxed{}$$

$$1872 \xrightarrow{\div 6} \boxed{} \xrightarrow{\div 2} \boxed{} \xrightarrow{\div 3} \boxed{} \xrightarrow{\div 4} \boxed{}$$

428

CMXXXVI

DCLIV

936

654

CDXXVIII

MXLII

1042

a)

	1	2	7
+	3	4	8

b)

	6	7	1
-	5	5	8

c)

	2	3	5
		×	3

 d) $847 \div 7 =$

a)

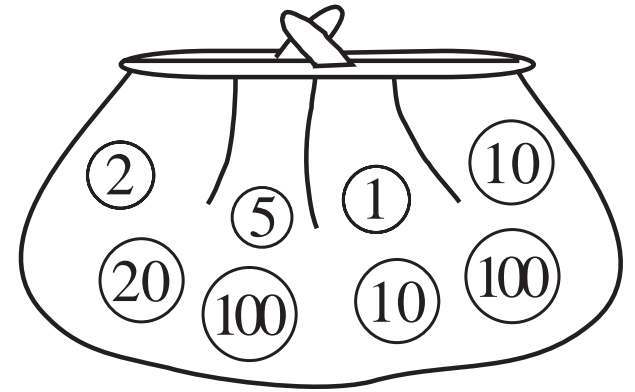
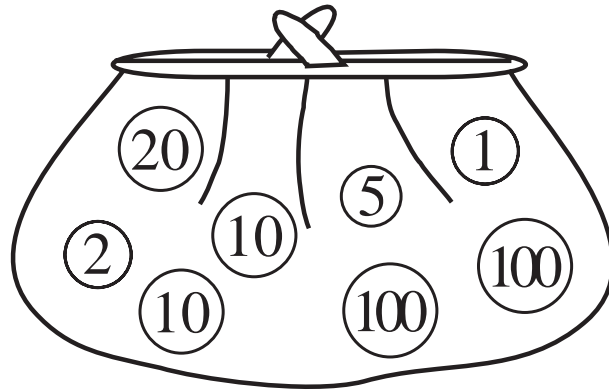
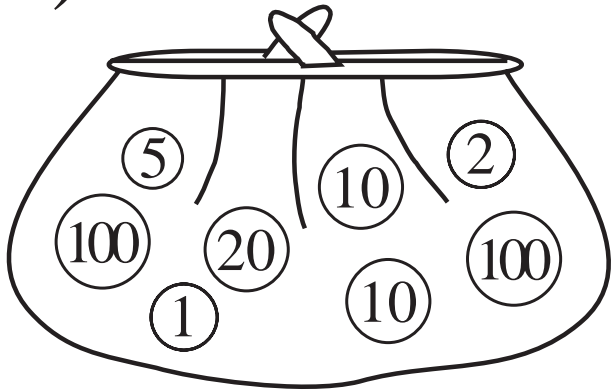

b)

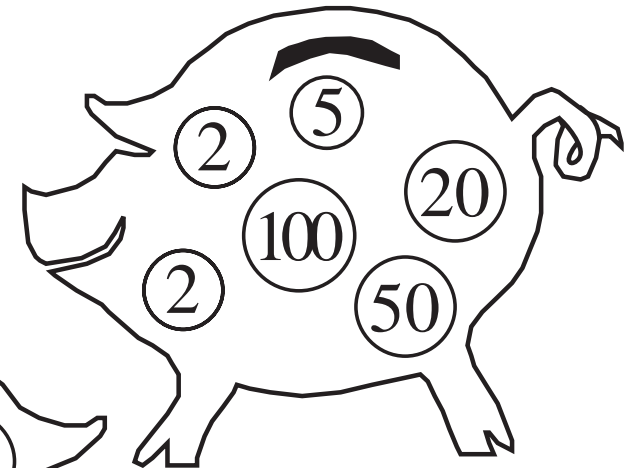
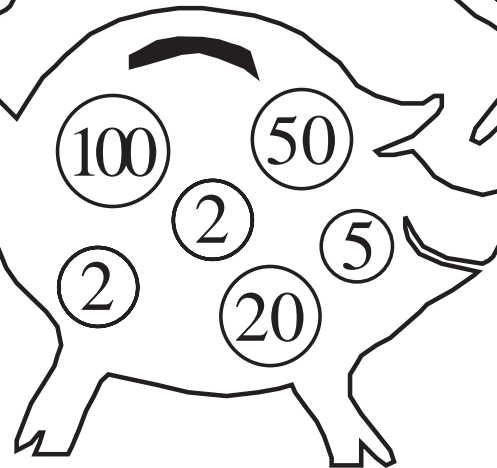
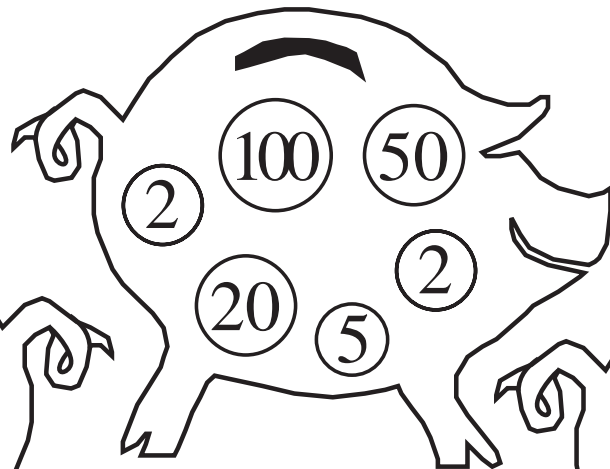
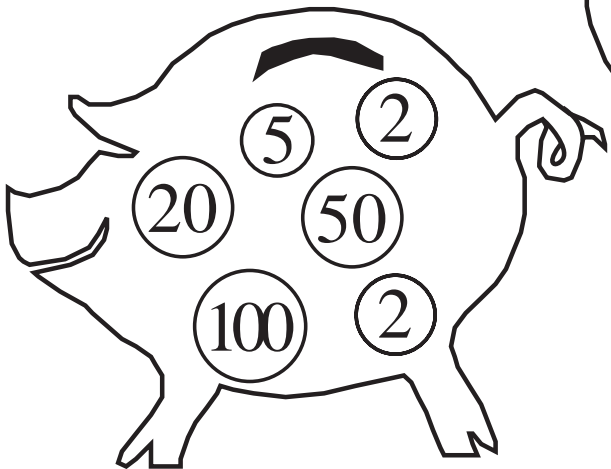

Monday

Income	Outgoings
£3.56	£2.18

Balance:

Tuesday

Income	Outgoings
£1.05	£3.46

Balance:

Wednesday

Income	Outgoings
£6.56	—

Balance:

Thursday

Income	Outgoings
£1.43	£3.25
£5.18	£1.89

Balance:

Friday

Income	Outgoings
£7.25	£1.03
£9.48	£4.28

Balance:

Saturday

Income	Outgoings
—	£5.23
	£2.18

Balance:

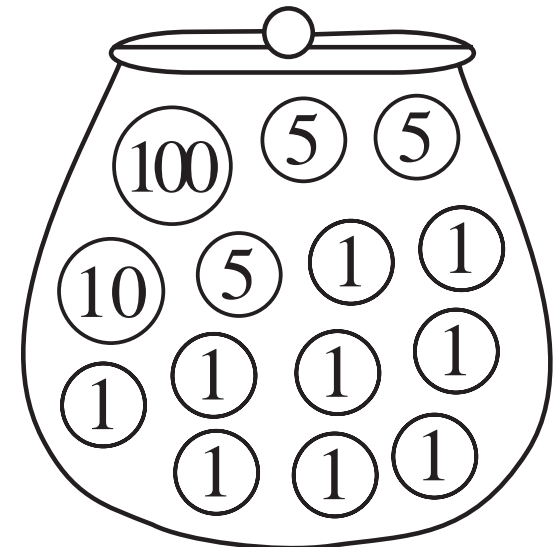
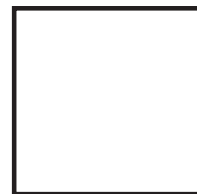
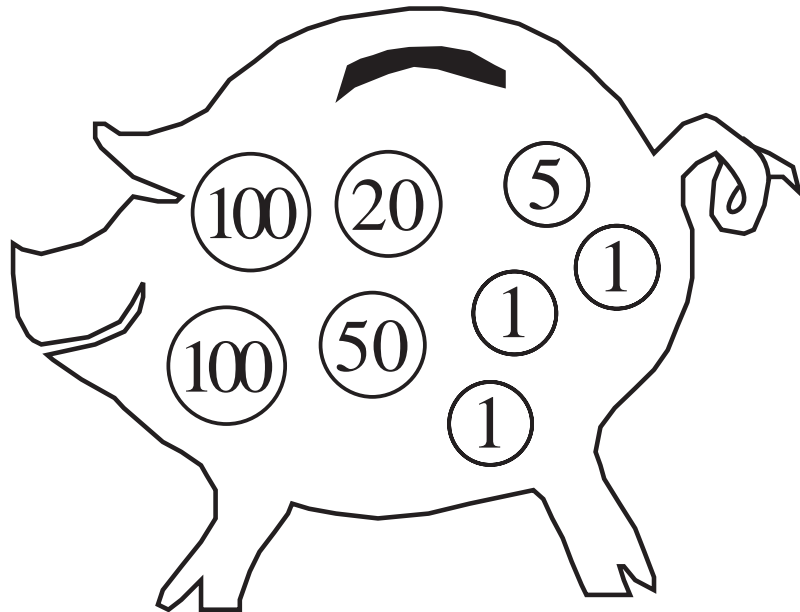
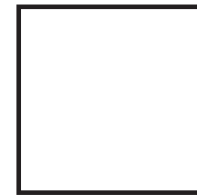
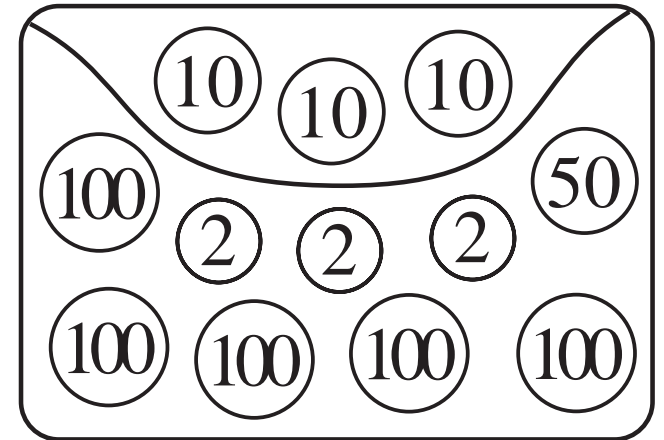
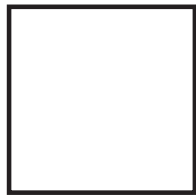
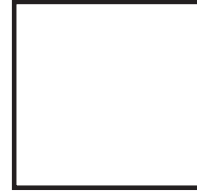
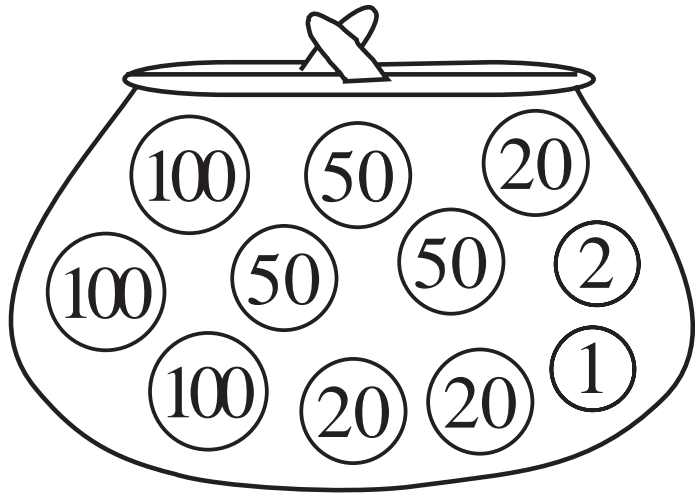

Had (p)	128	556	436		216		405
Was given (p)	342	223	578	329		149	
Now has (p)				674	971	583	752

$$N =$$

$$H =$$

$$W =$$

LP 159/4

S (£)	321			276	187			639	0	
P (£)		542	138			456	223			752

$$754 =$$

$$S =$$

$$P =$$

LP 159/5

a)

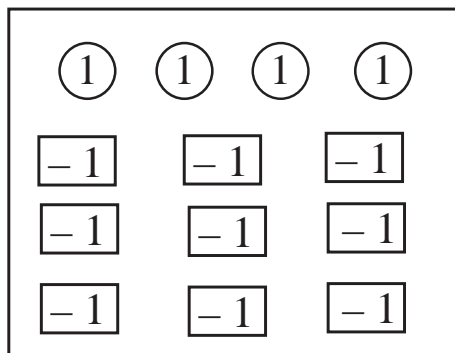

b)

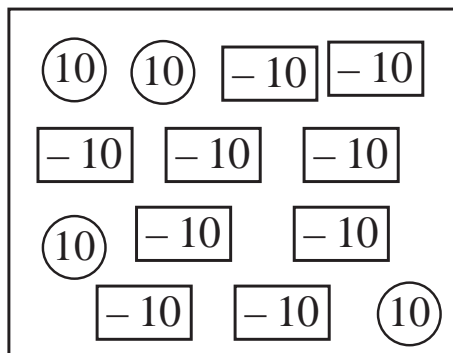

c)

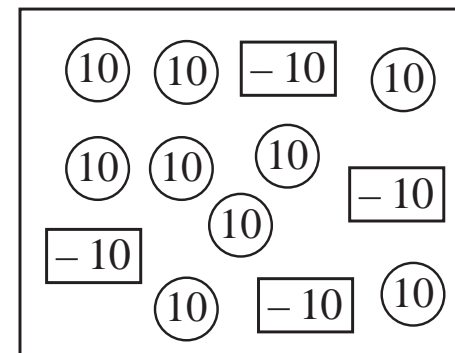

LP 159/8

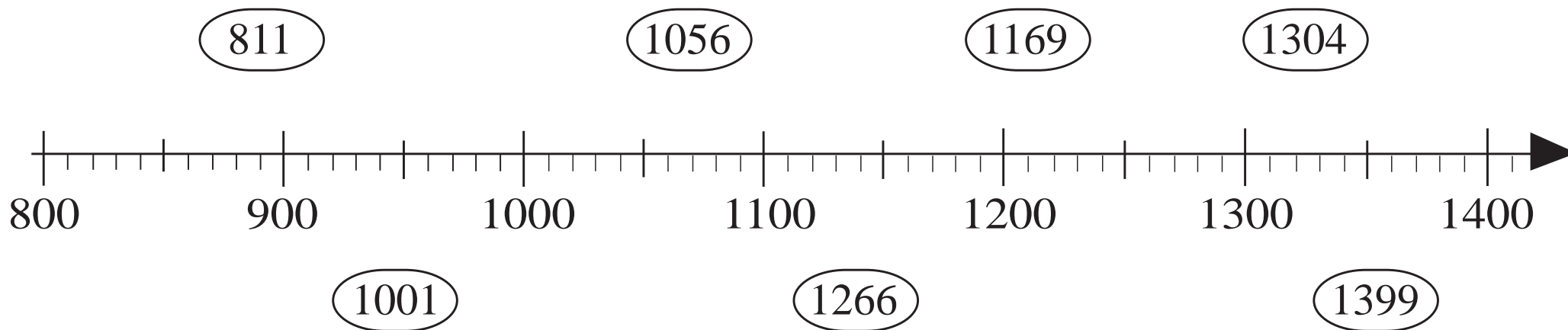

LP 160/2

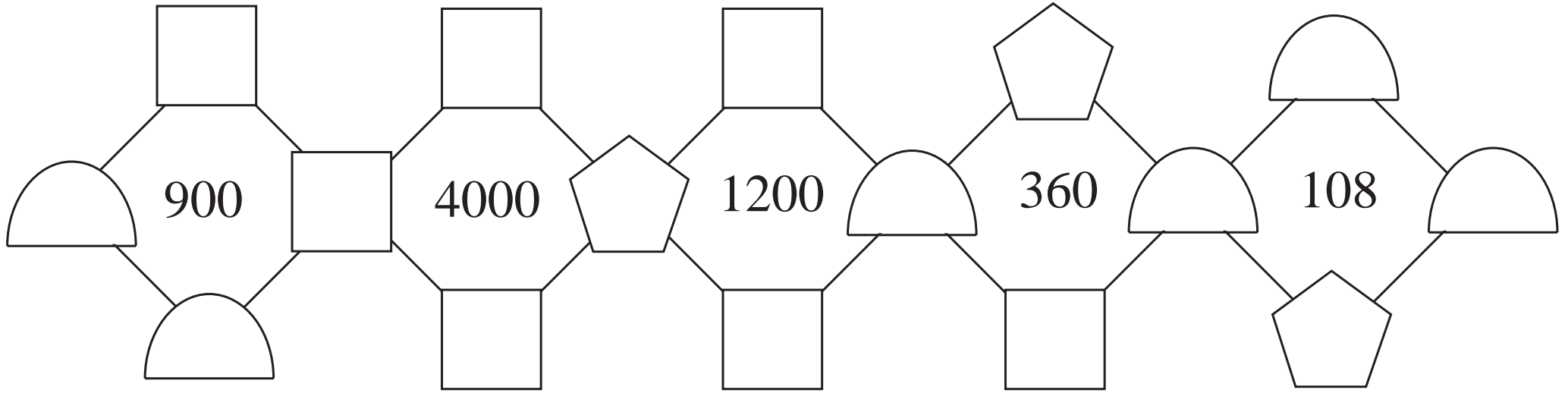

LP 160/3

a)

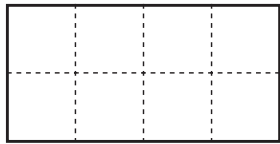

5 eighths

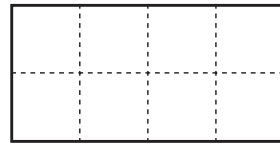

7 eighths

b)

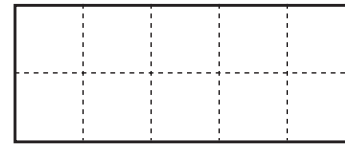

7 tenths

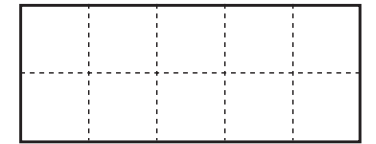

1 half

c)

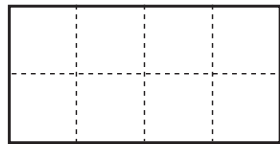

3 quarters



3 eighths

d)

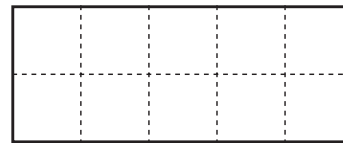

3 fifths

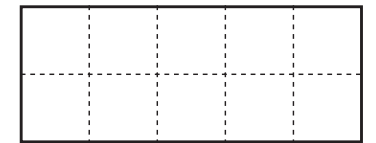

1 quarter

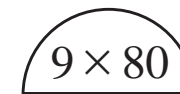
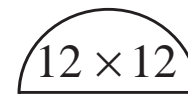
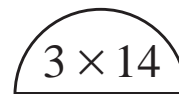
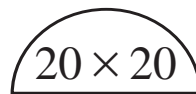
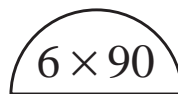
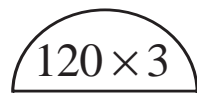
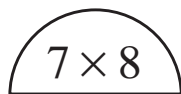
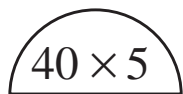
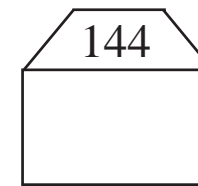
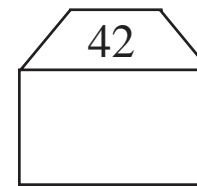
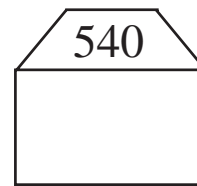
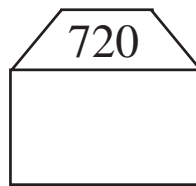
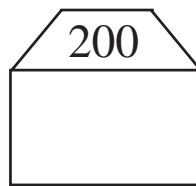
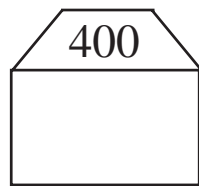
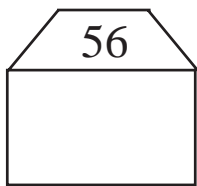
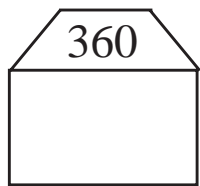

LP 161/1

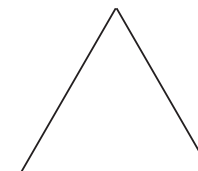
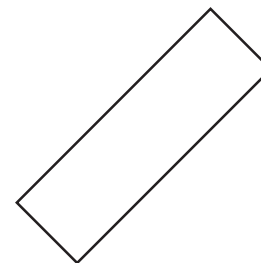
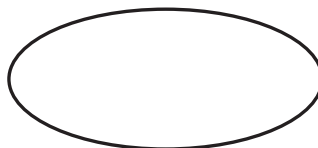
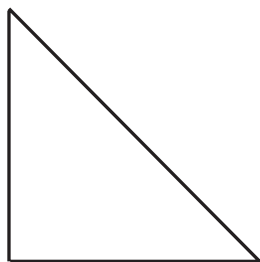
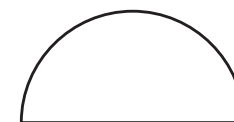
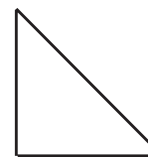
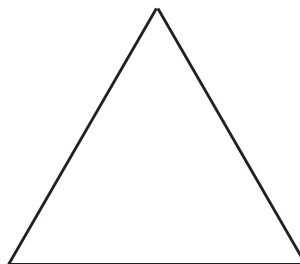
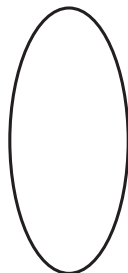
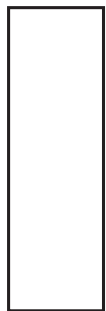
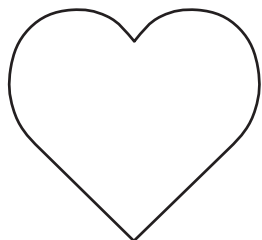

LP 161/7

70 to 90

Multiple of 8

Multiple of 9

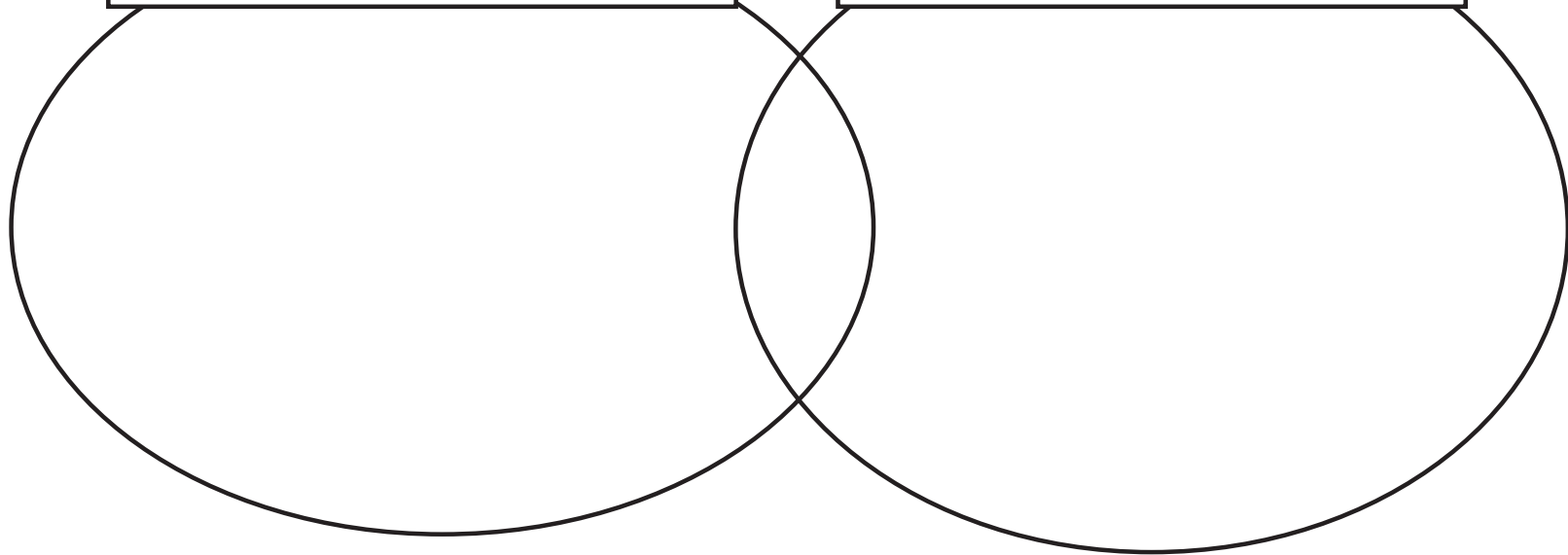

	230	
250	270	
	310	240

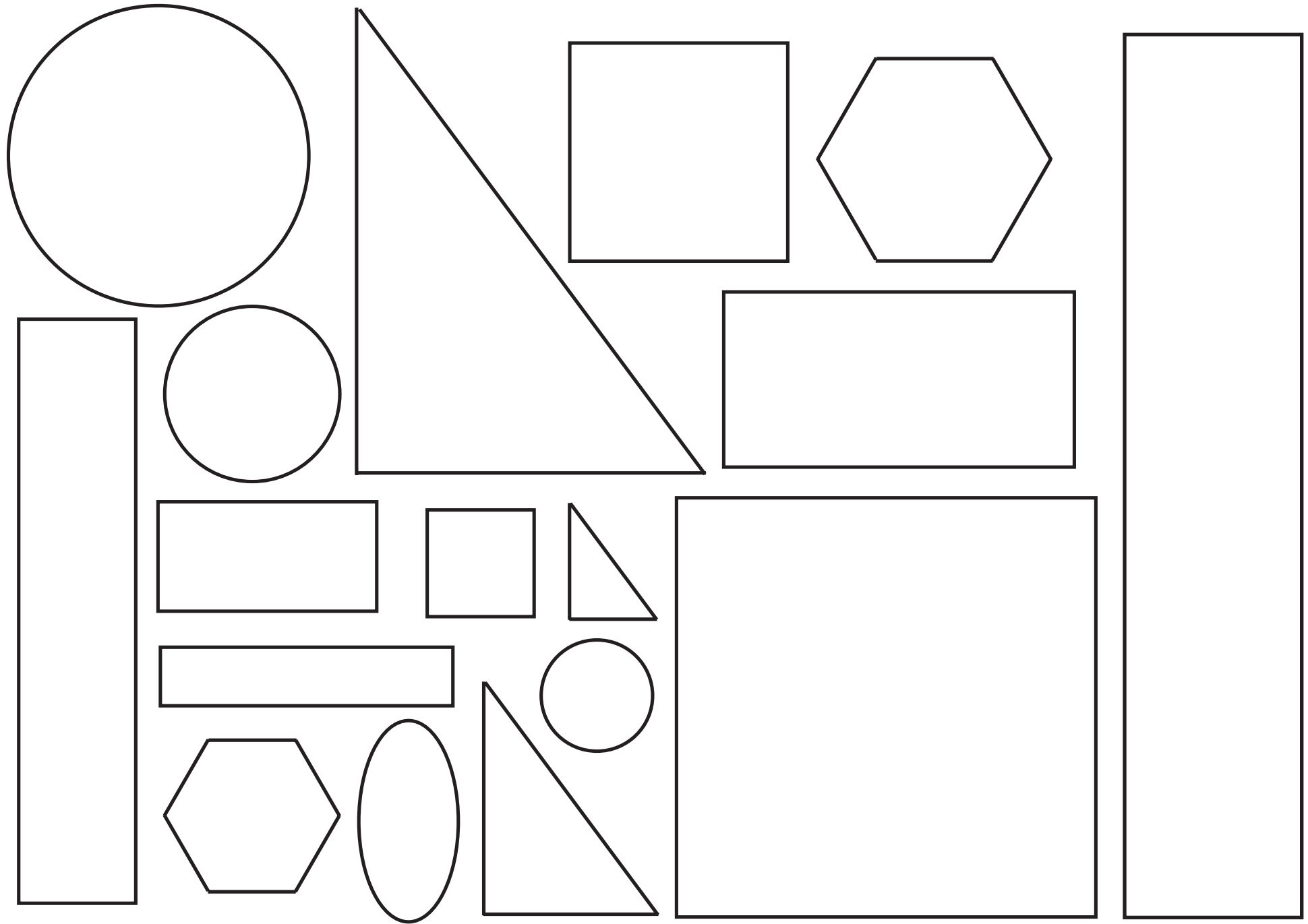

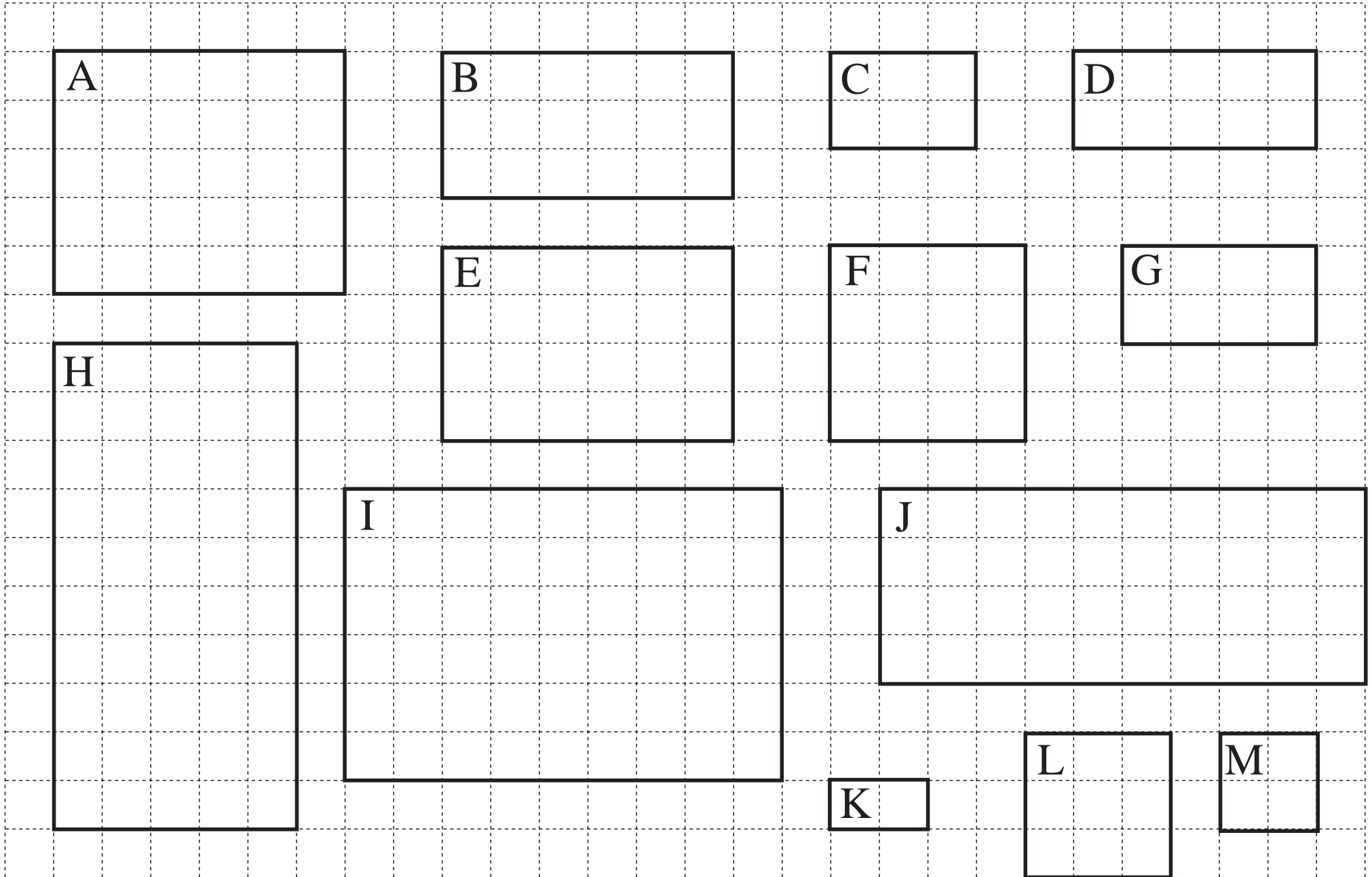

A 10x10 grid with 12 rectangles labeled A through M. The rectangles are:

- A: 3x4
- B: 2x4
- C: 1x2
- D: 1x4
- E: 2x4
- F: 2x3
- G: 1x3
- H: 4x3
- I: 3x5
- J: 2x6
- K: 1x2
- L: 1x3
- M: 1x2

a)

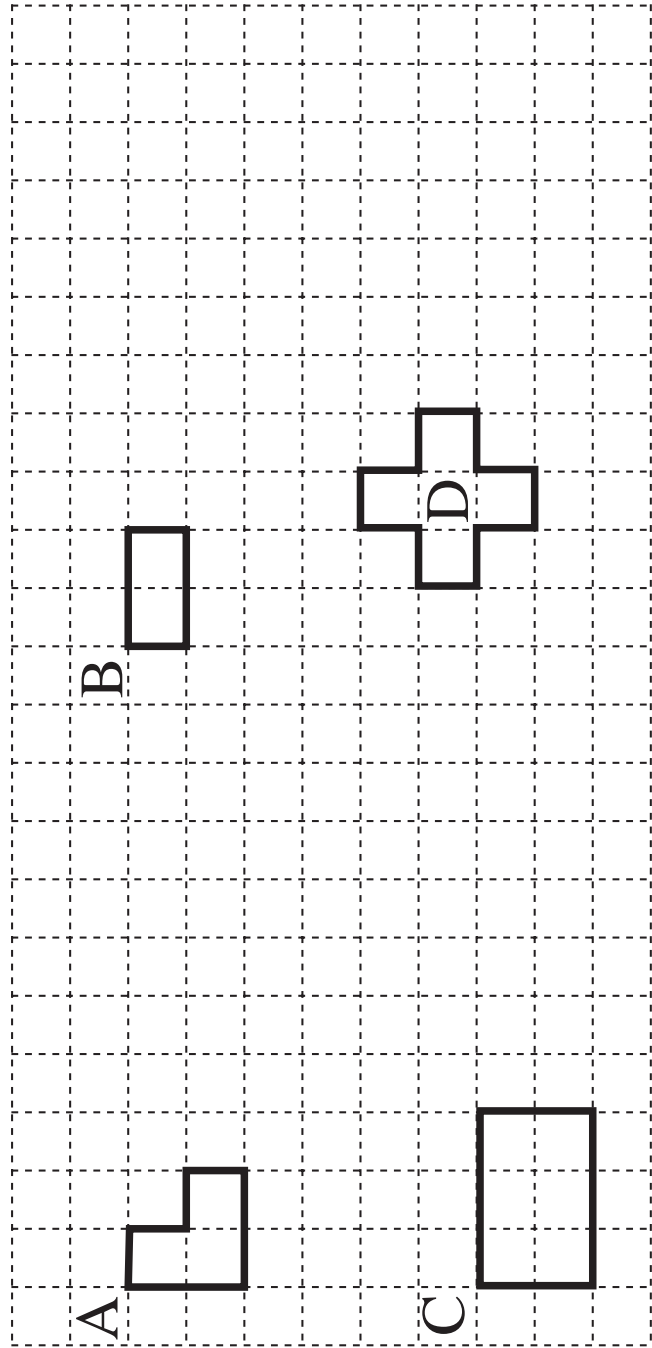

b)

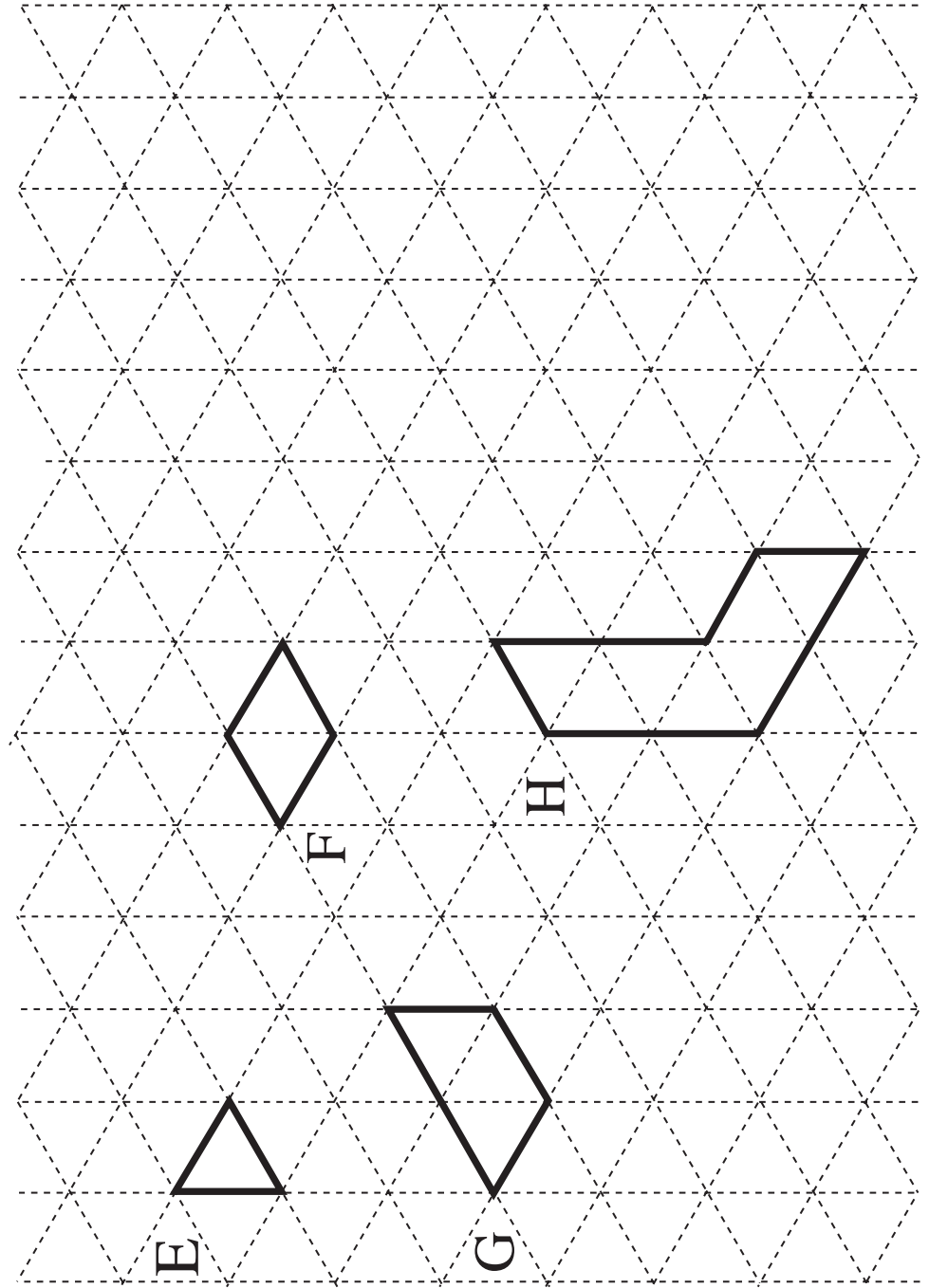

a)

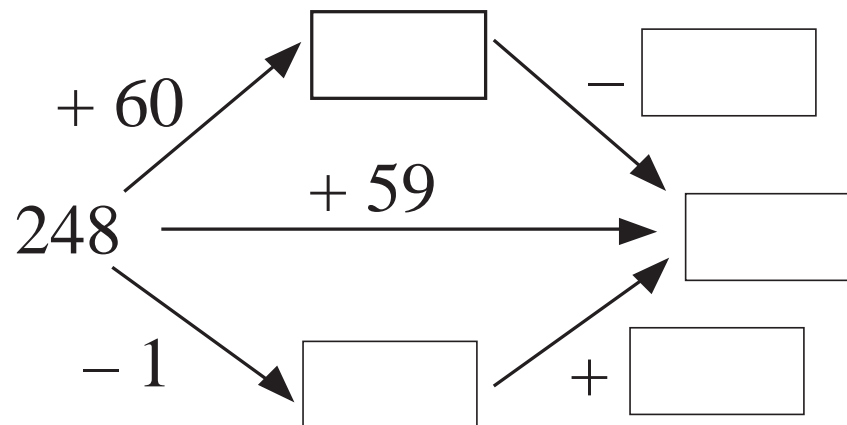
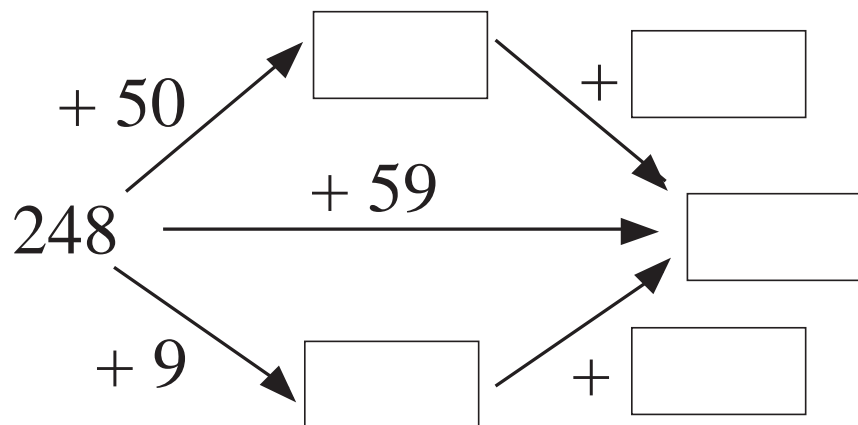

b)

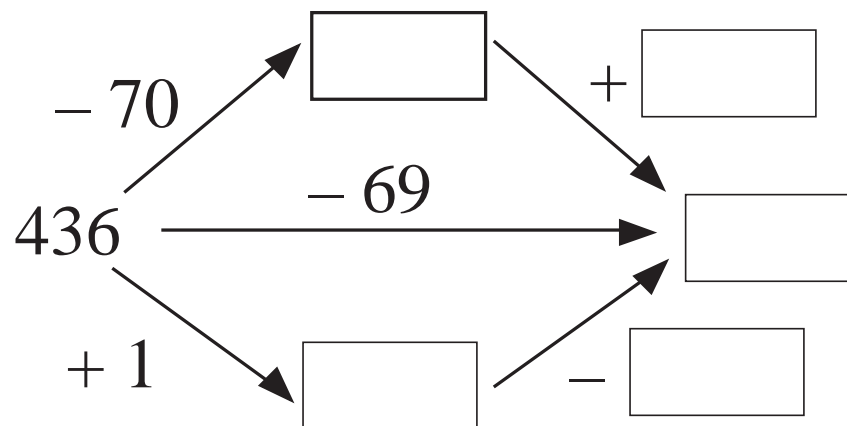
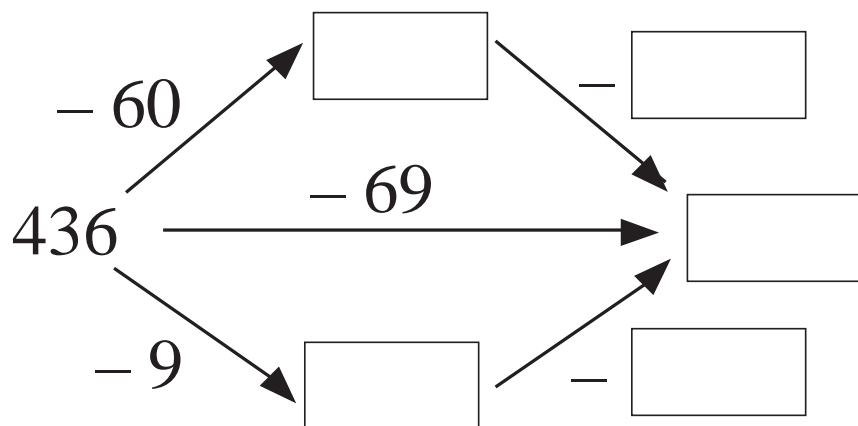

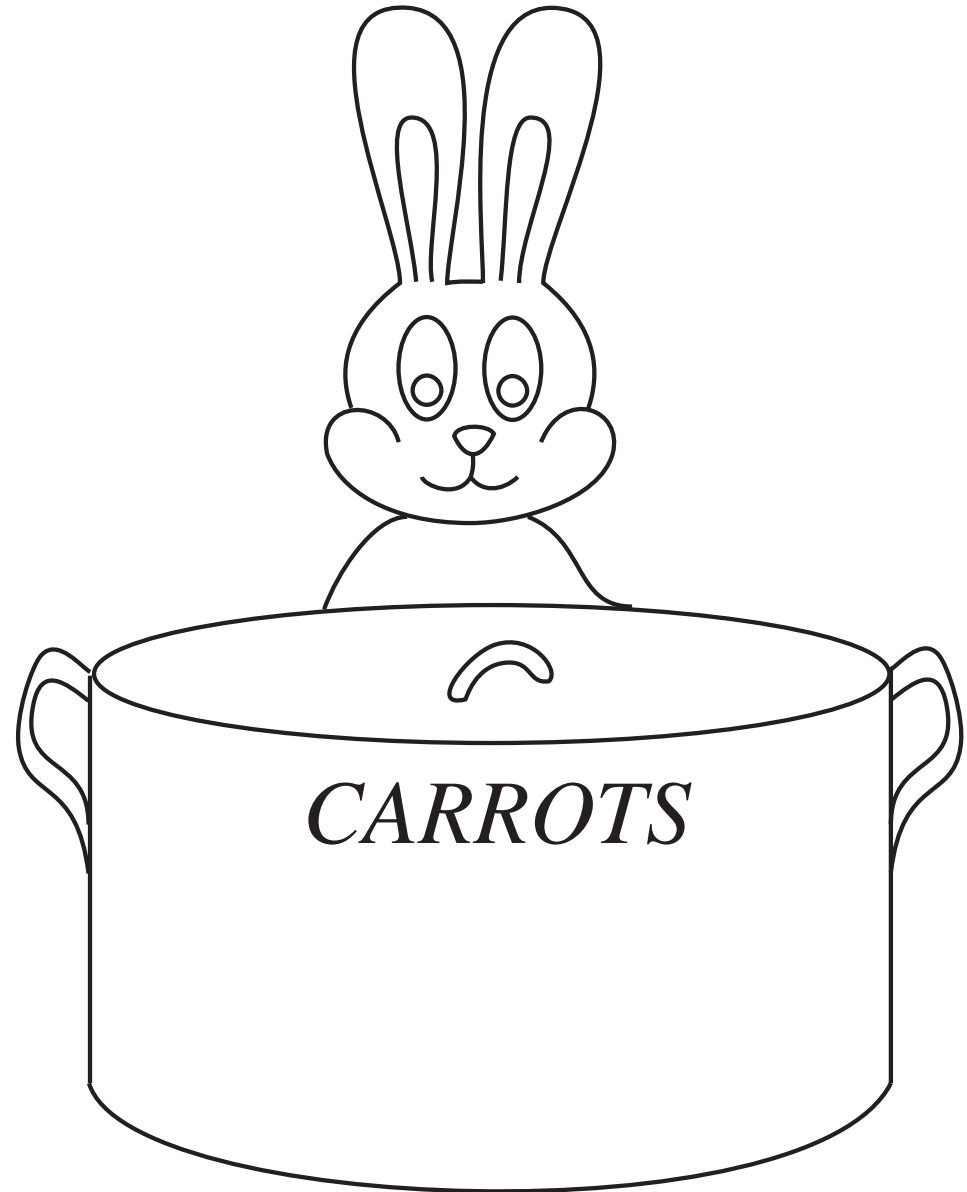

B

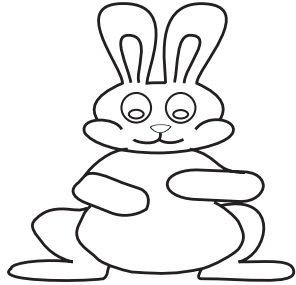

D

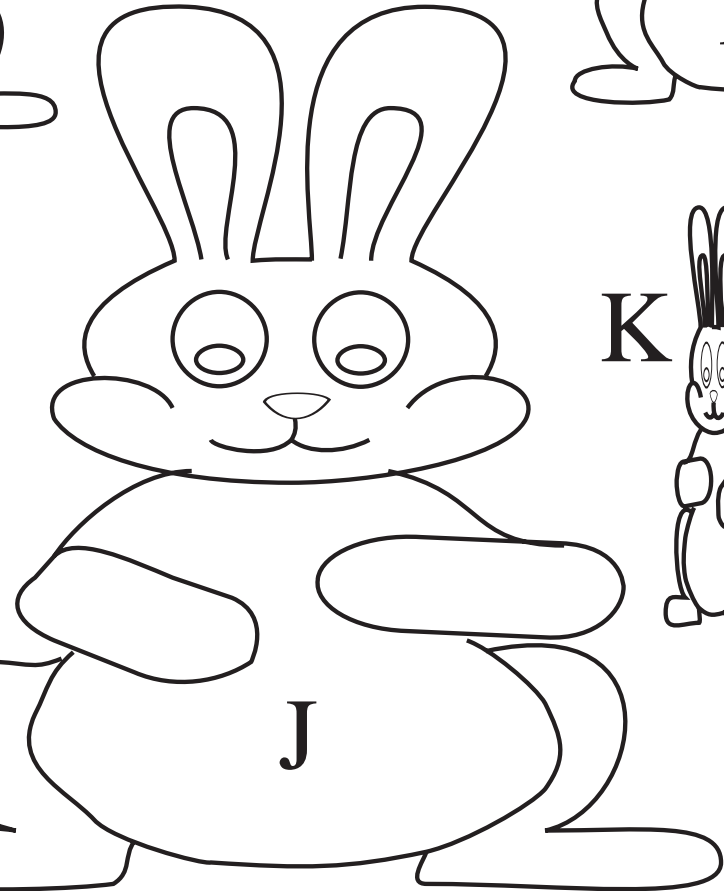
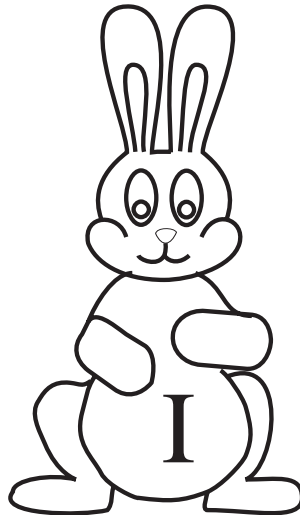
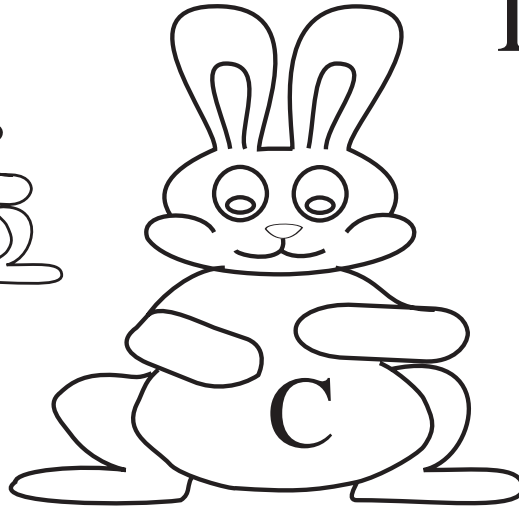
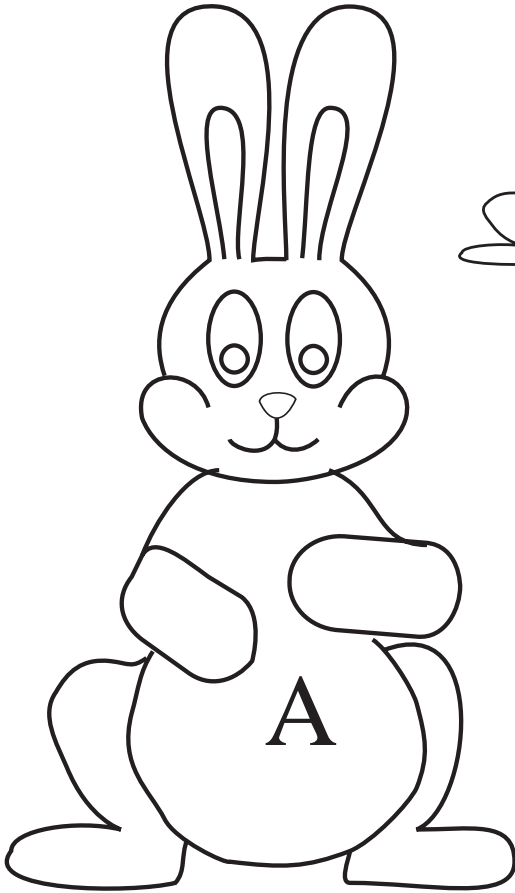
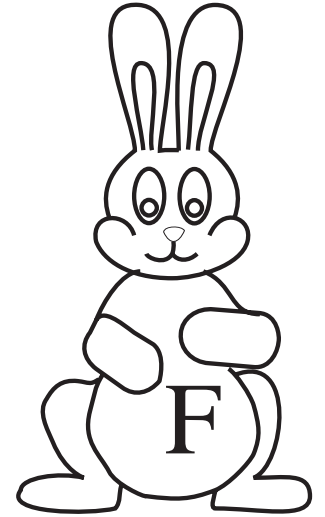
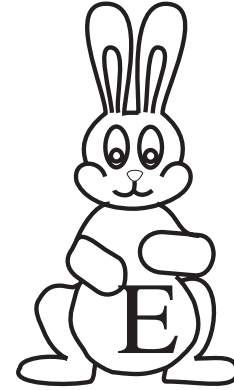

K

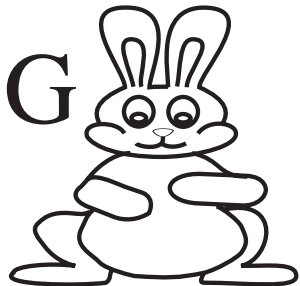

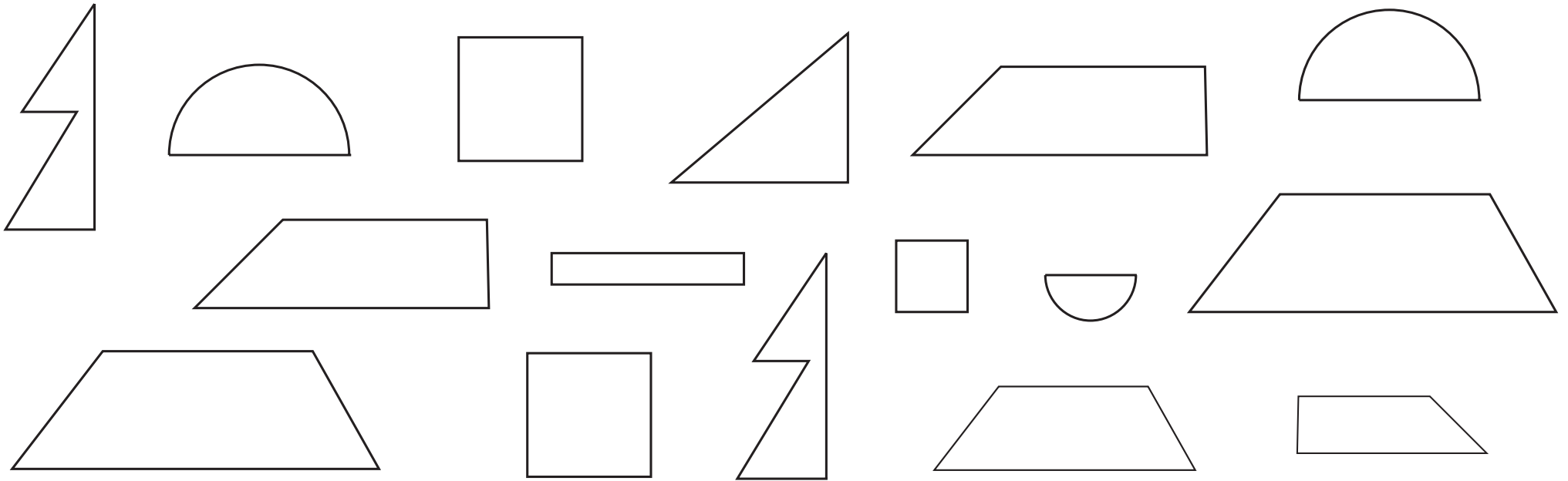

LP 162/6

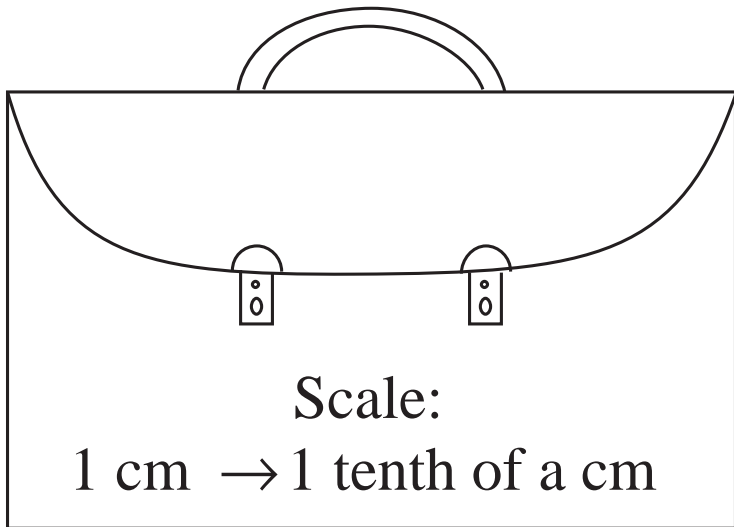

On plan:	Length (cm)	
	Height (cm)	
In real life:	Length (cm)	
	Height (cm)	

LP 162/8

① The whole site

Scale: 1 mm → 1 m

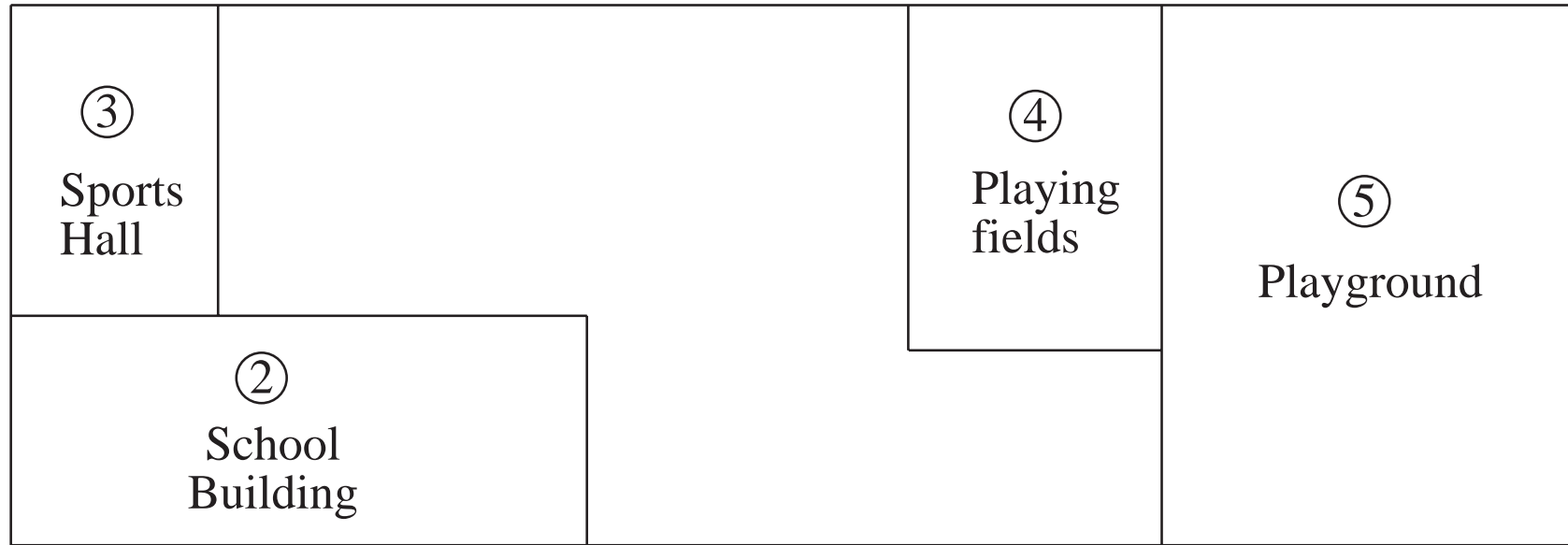

Rectangle	①	②	③	④	⑤
On plan: Length (mm)					
Width (mm)					
In real life: Length (m)					
Width (m)					

16, 27, 25, 53, 46, 57, 60, 35, 31, 47, 14, 58, 54

Remainder after dividing by 5

0	1	2	3	4

Remainder after dividing by 6

0	1	2	3	4	5

a)

	6	4	8
+			
<hr/>			
	9	2	9

+	3	4	5
<hr/>			
	6	4	8

	9	9	9
+			
<hr/>			
1	8	8	8

+	9	9	5
<hr/>			
1	0	5	0

b)

		5	3
+	4	6	
<hr/>			
	0		3

	3	5	
+			5
<hr/>			
	5	4	3

	5		8
+		3	
<hr/>			
1	0	4	8

	3		8
+	6	1	7
<hr/>			
		5	

LP 163/3

a)

	8	5	3
-			
<hr/>			
	1	3	2

b)

-	1	7	5
<hr/>			
	6	0	8

c)

			5
-	4	3	
<hr/>			
	2	9	6

d)

		3	8
-	5		
<hr/>			
	2	1	9

e)

1	2		
-	4	9	6
<hr/>			
		2	5

LP 164/2

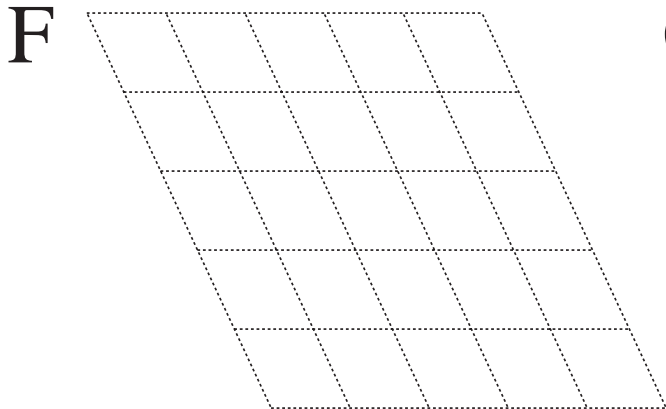
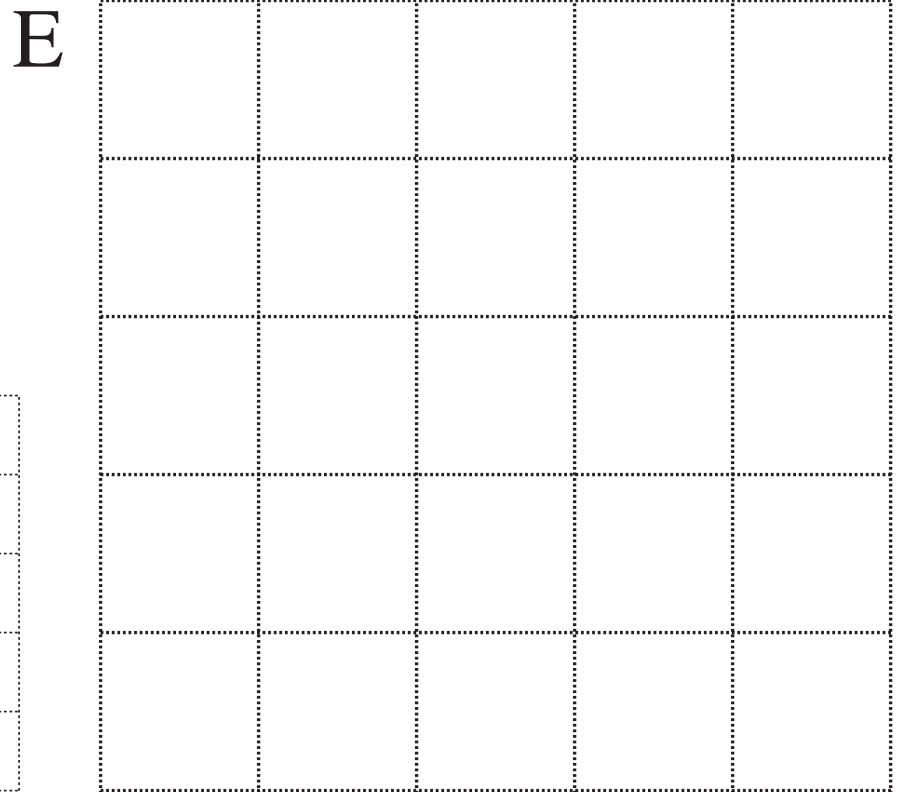
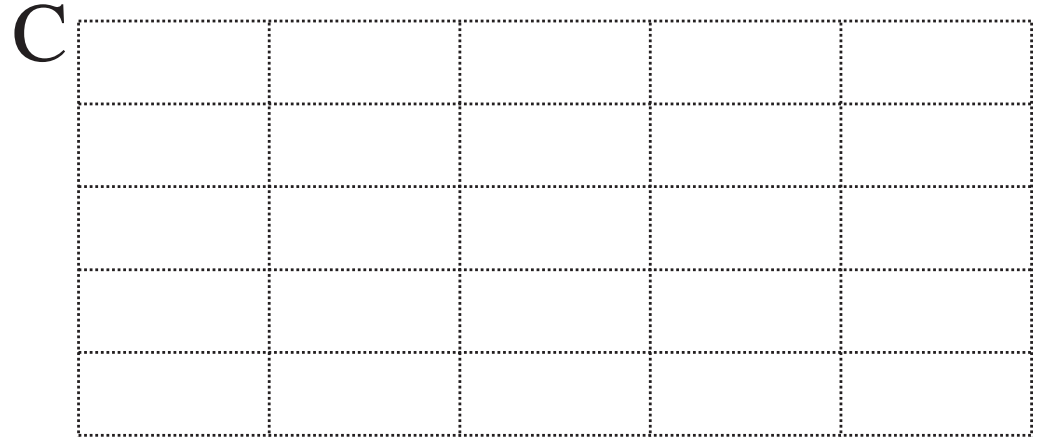
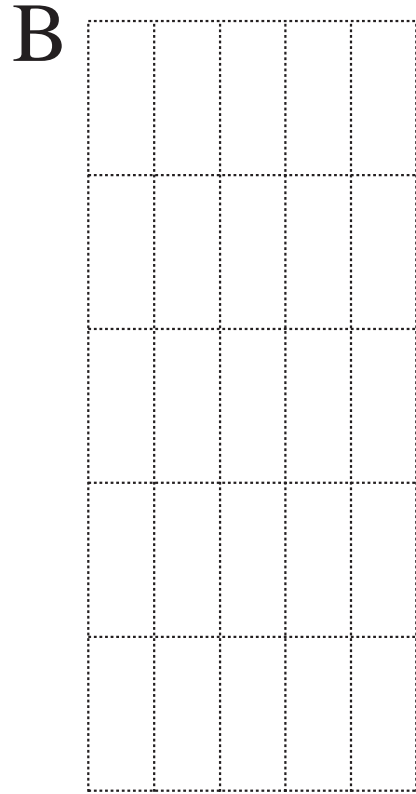
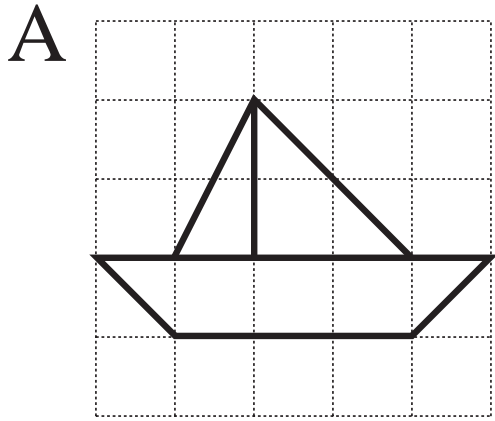

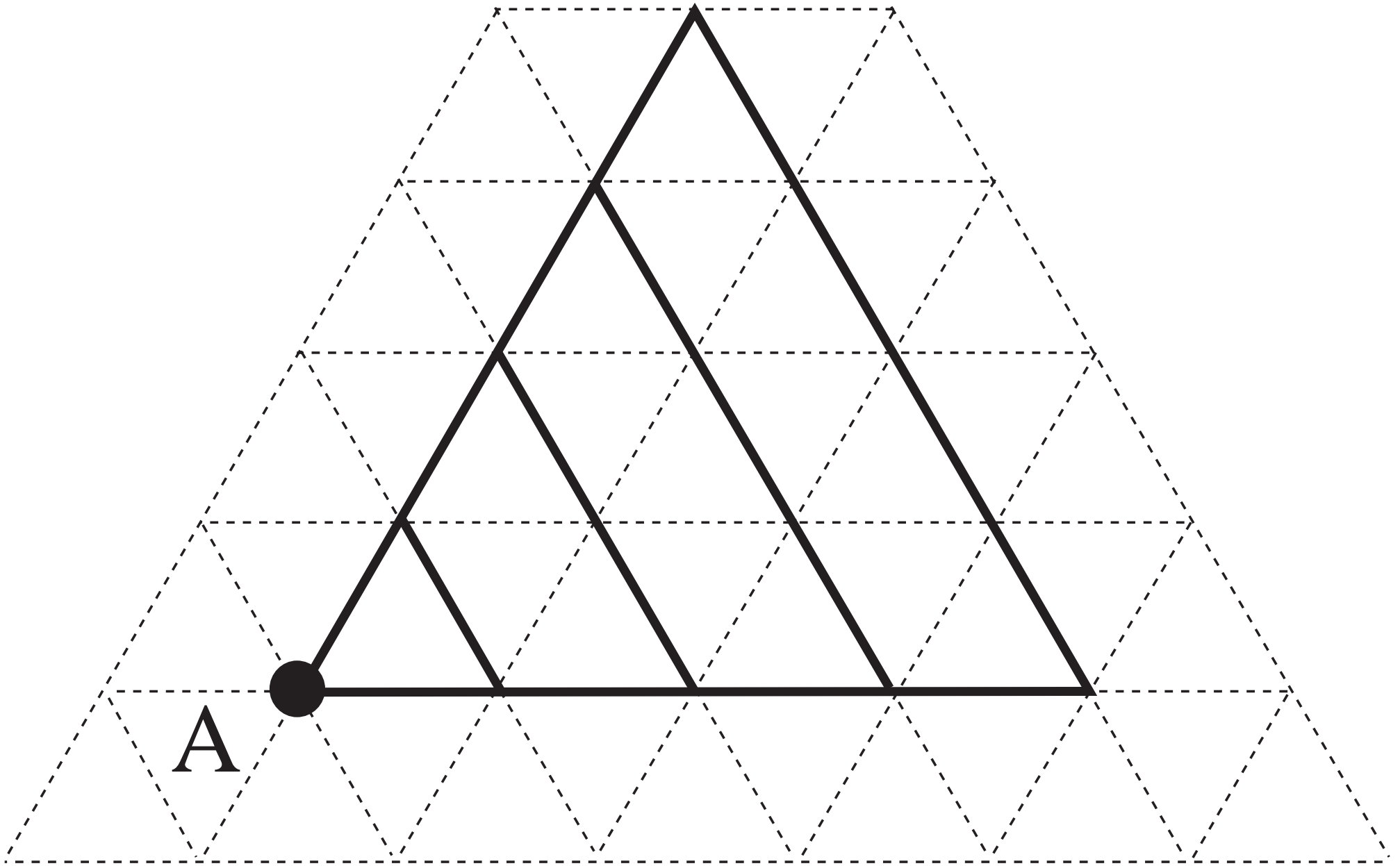

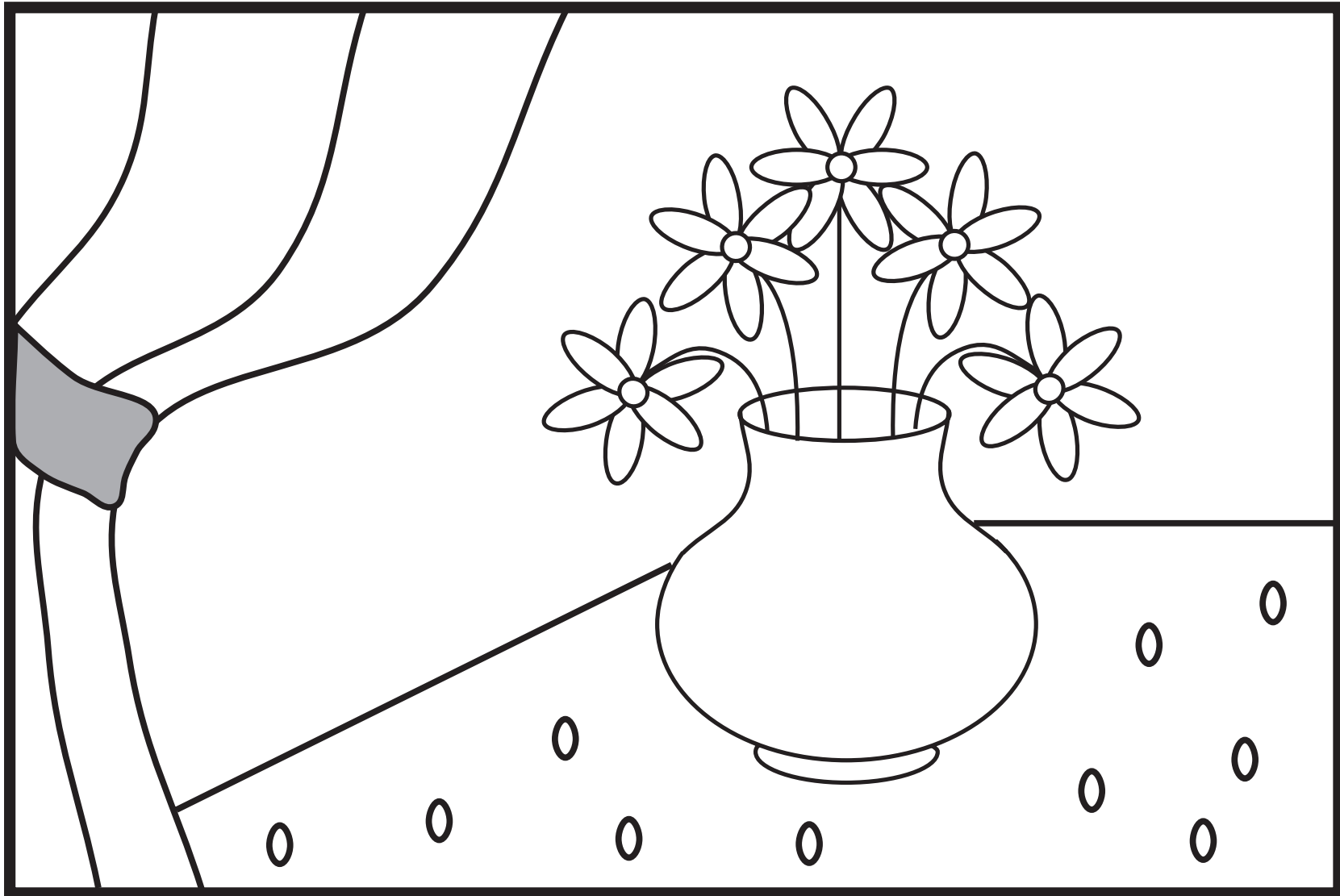

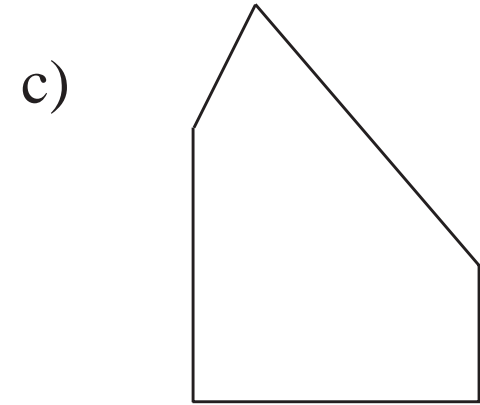
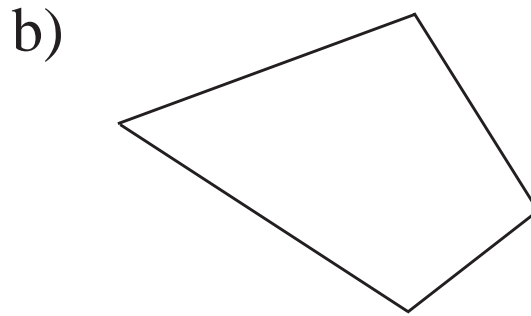
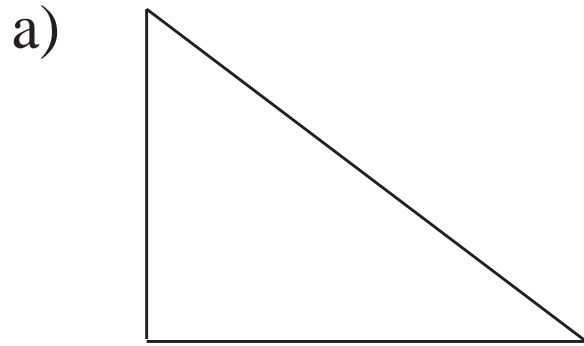

a)

$$P = \boxed{} \text{ mm} = \boxed{} \text{ cm} \boxed{} \text{ mm}$$

b)

$$P = \boxed{} \text{ mm} = \boxed{} \text{ cm} \boxed{} \text{ mm}$$

c)

$$P = \boxed{} \text{ mm} = \boxed{} \text{ cm} \boxed{} \text{ mm}$$

a)

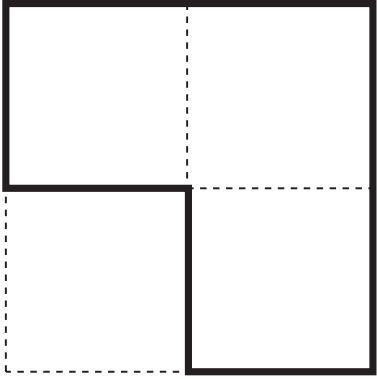

$P = \dots$



$A = \dots$

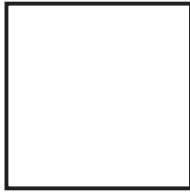

b)

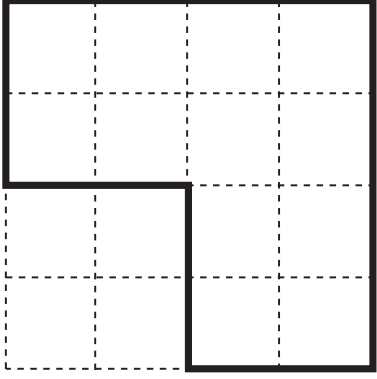

$P = \dots$



$A = \dots$



c)

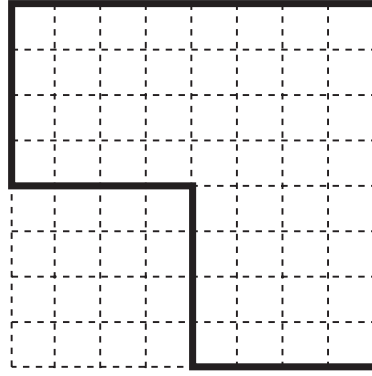

$P = \dots$



$A = \dots$



d)

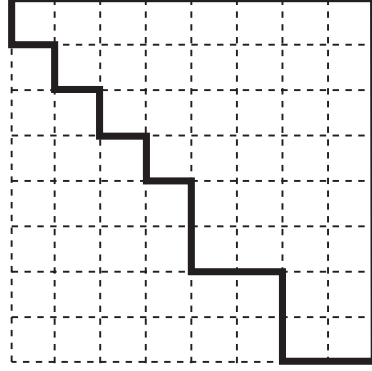

$P = \dots$



$A = \dots$



a)

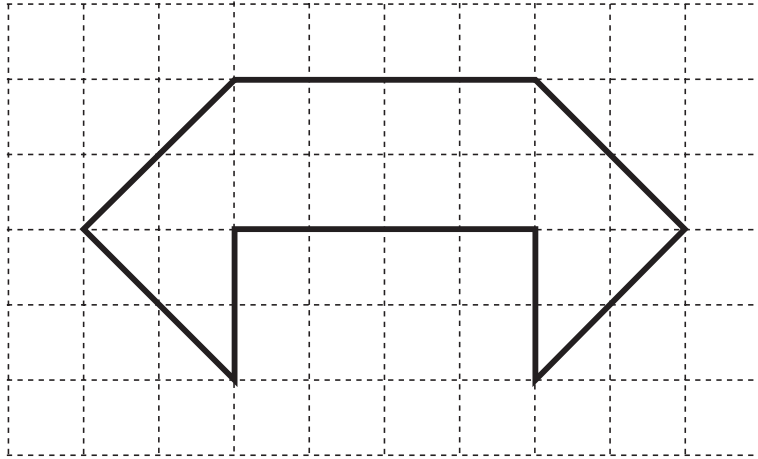

 a) $A =$ unit squares

 b) $A =$ unit squares

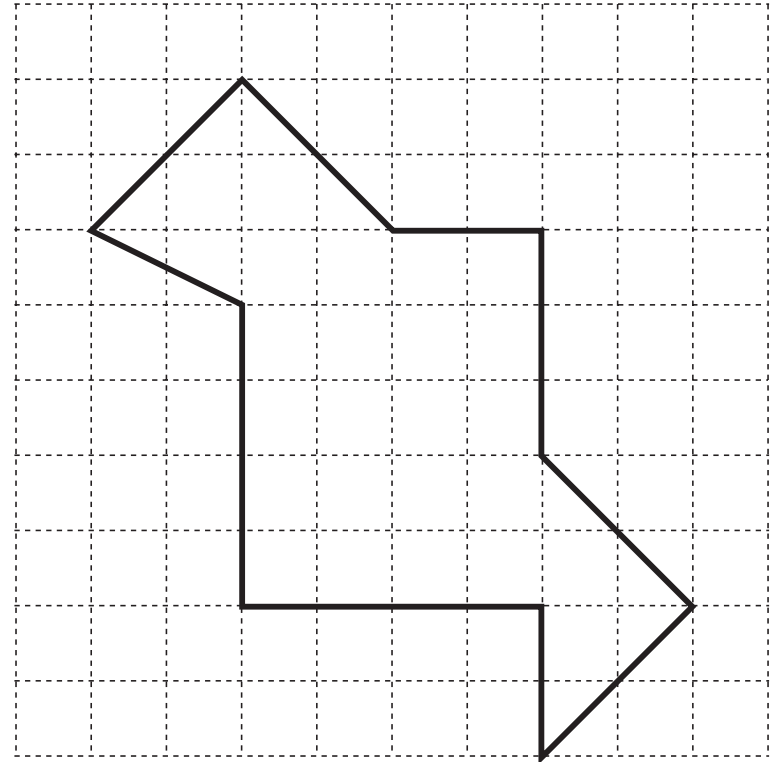
b)

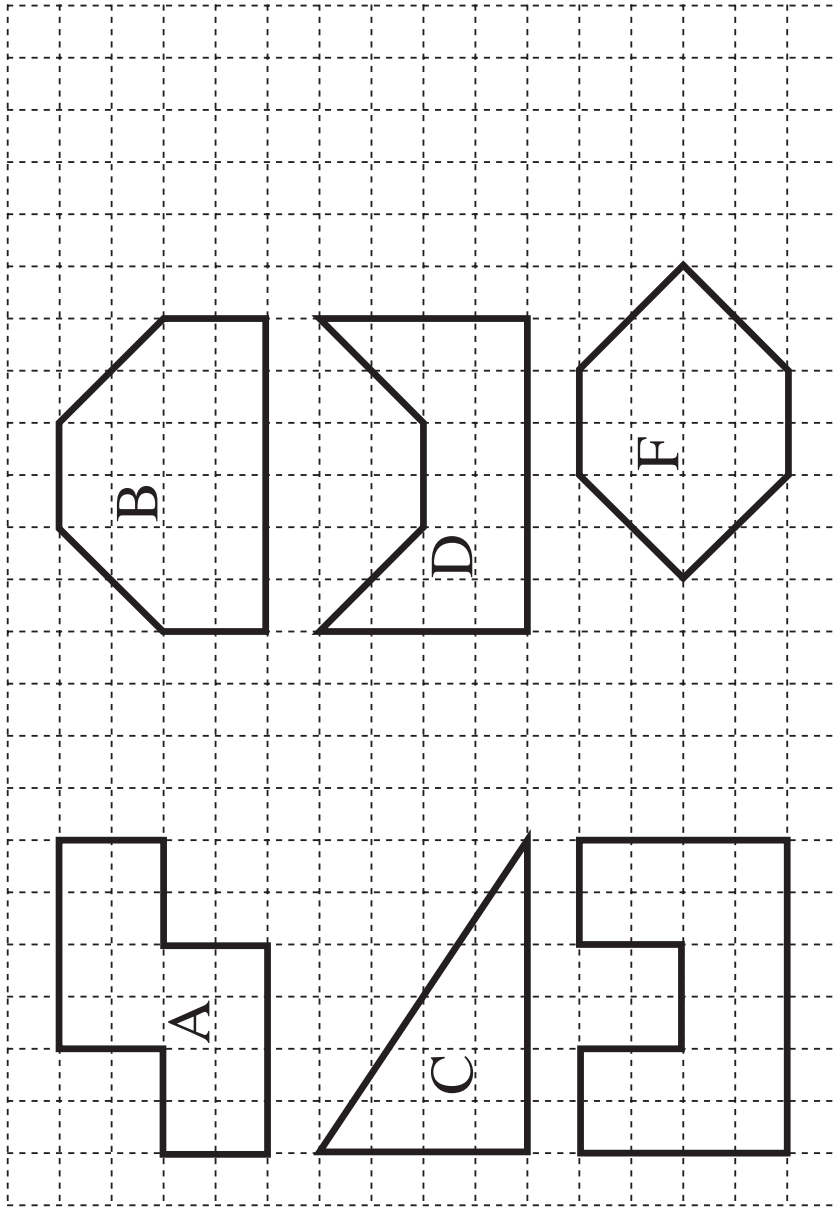

a)



b)

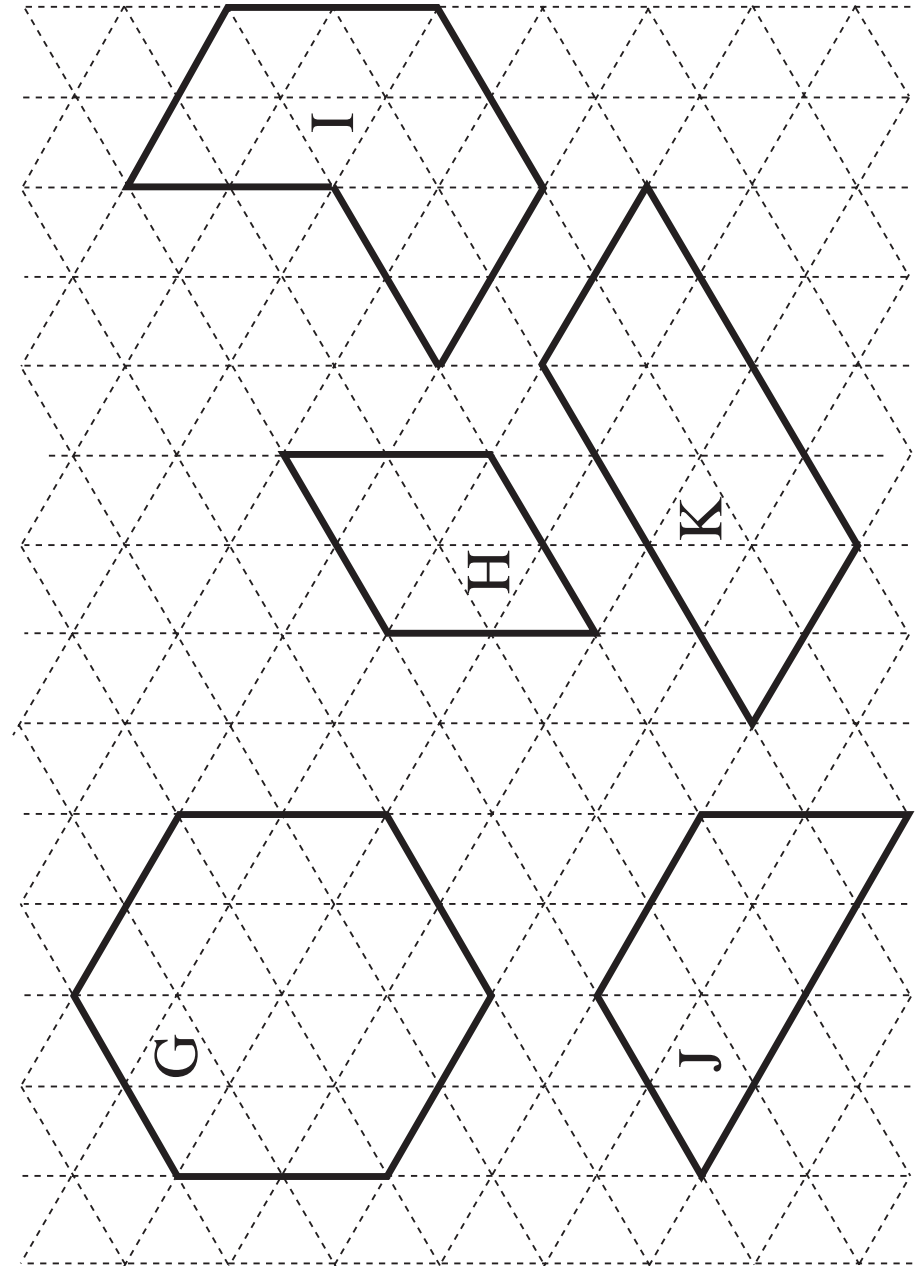

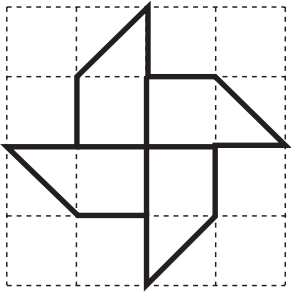

Copy this drawing on the different grids.

a)

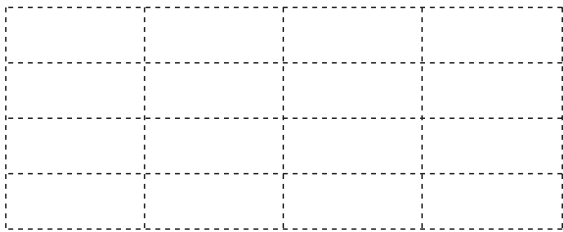

b)

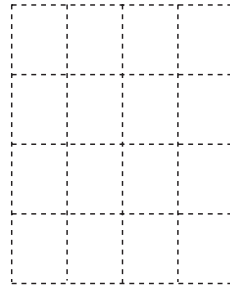

c)

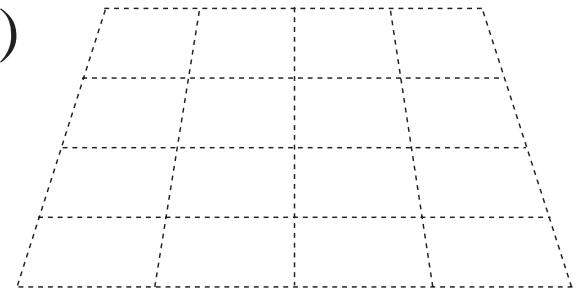

d)

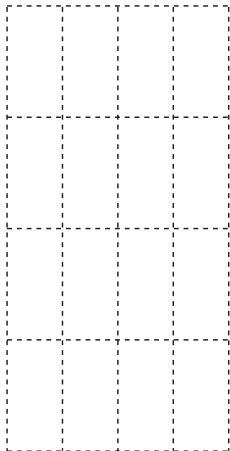

e)

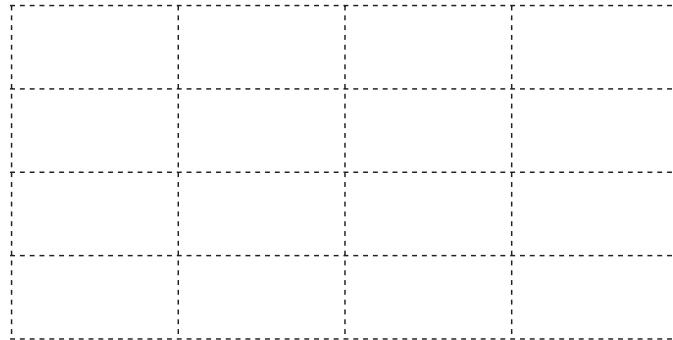

f)

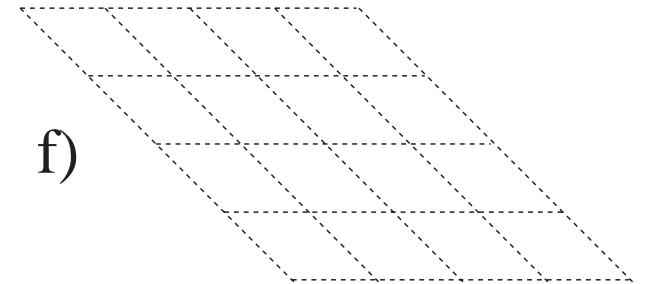

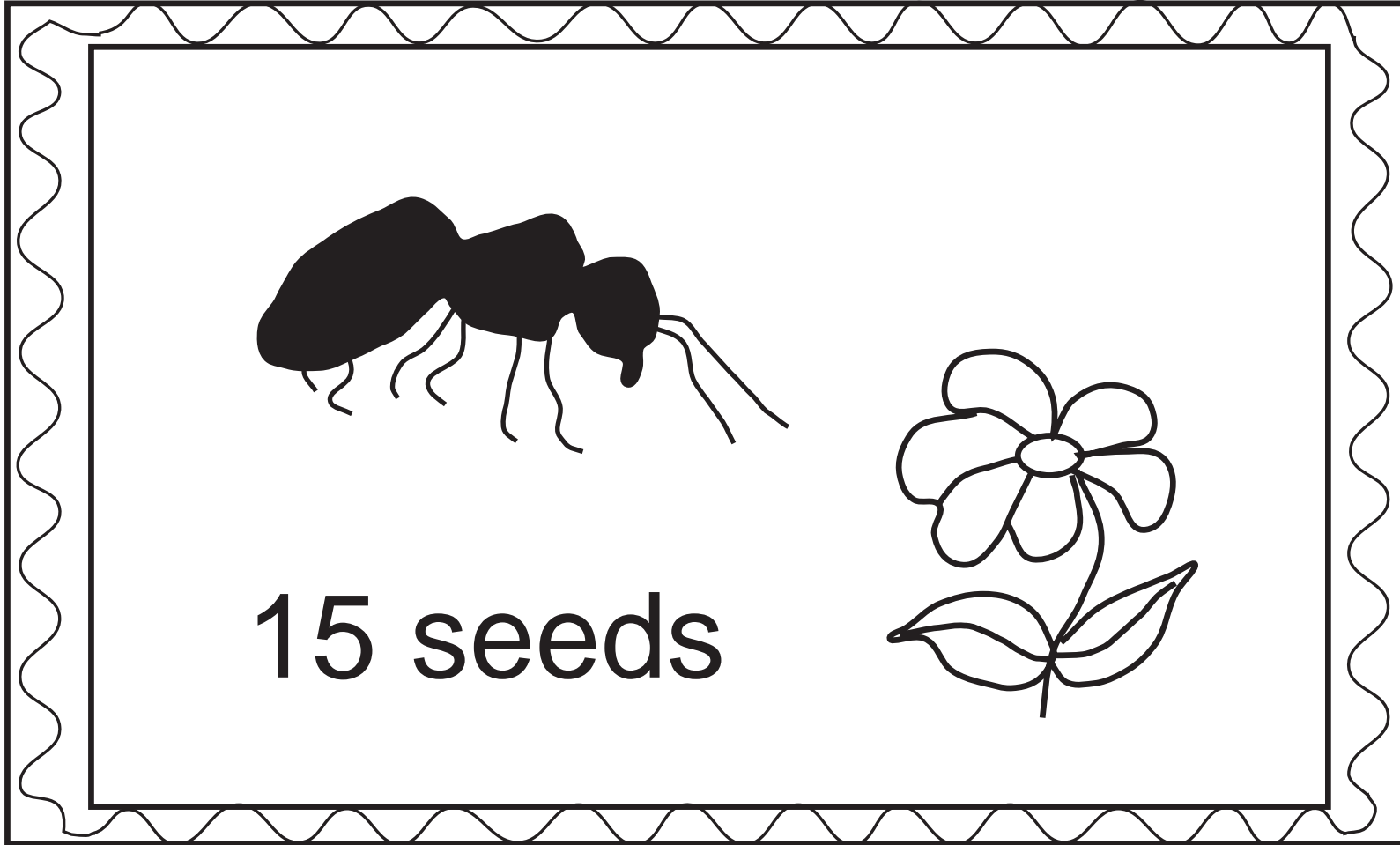

$$A = \{1, 2, 3, 4, 5, 6, 7, 8, 9, 10, 12, 15, 16, 18, 20, 21, 24, 30\}$$

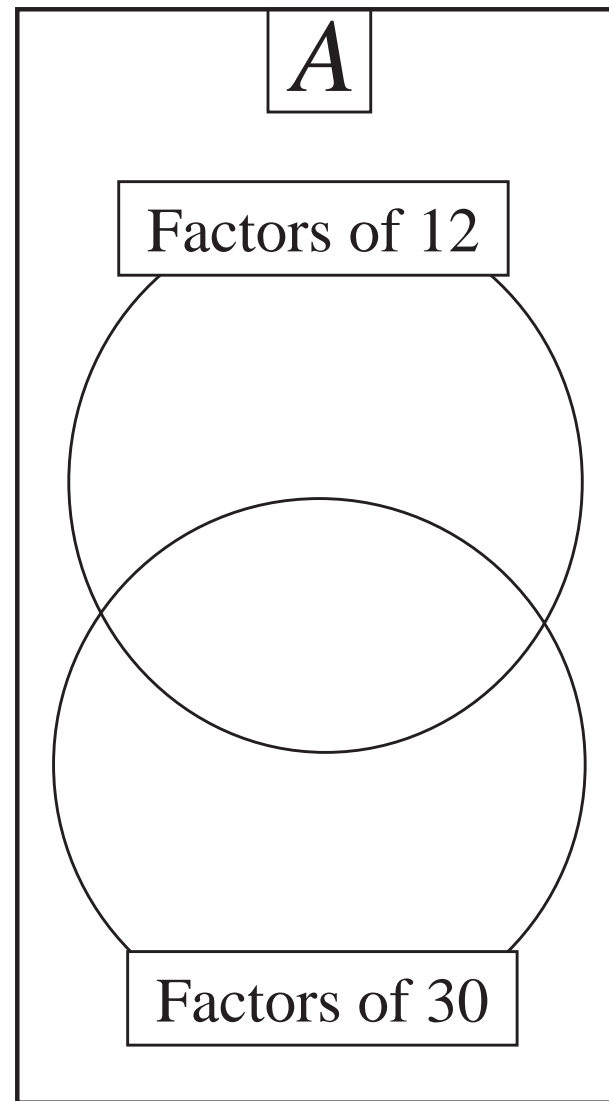
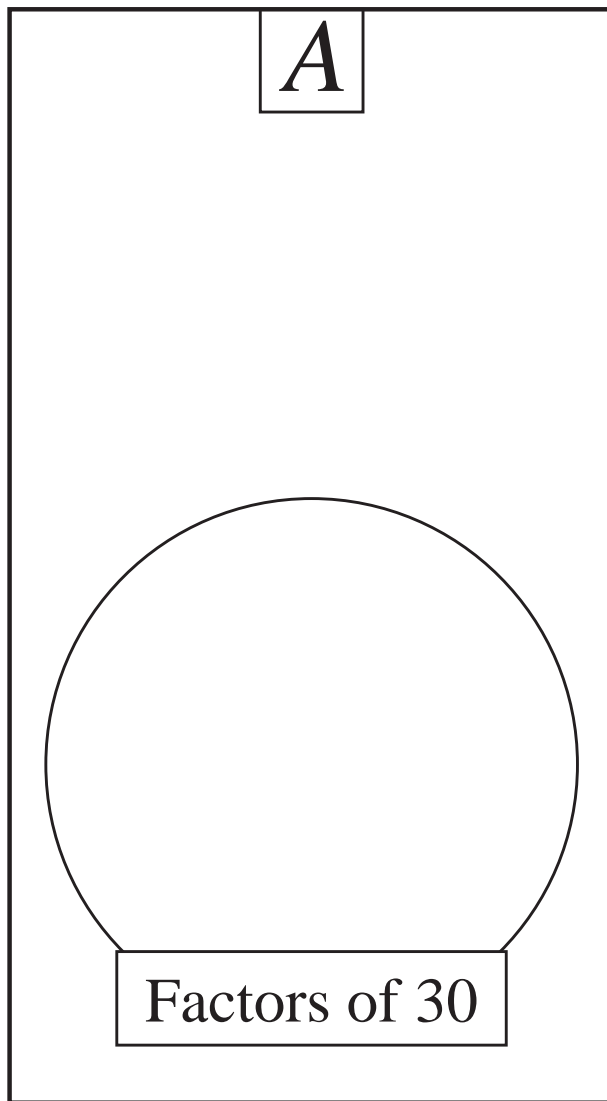
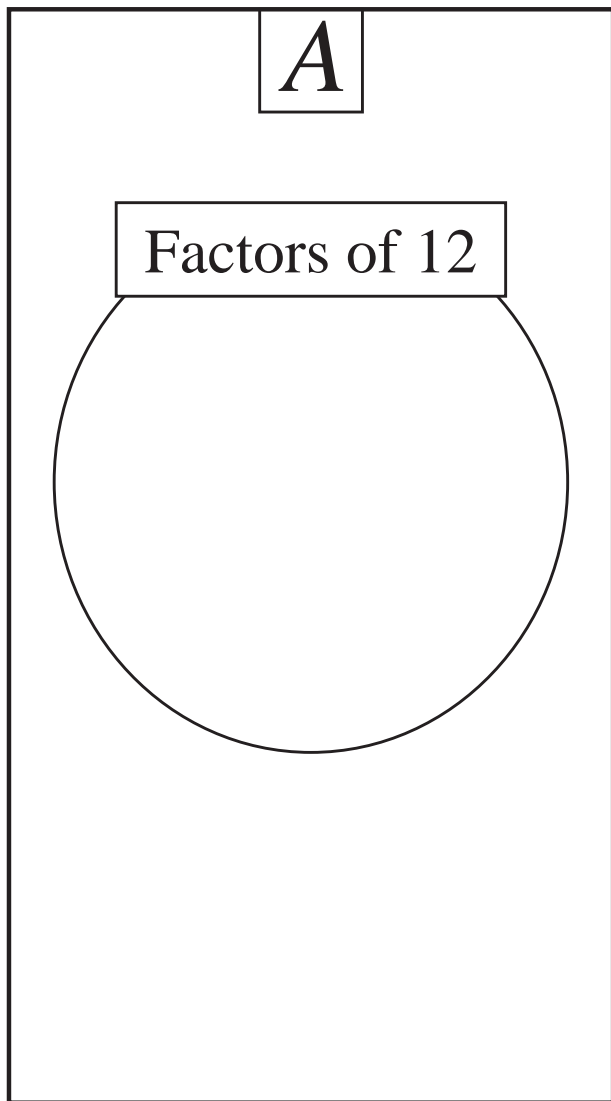

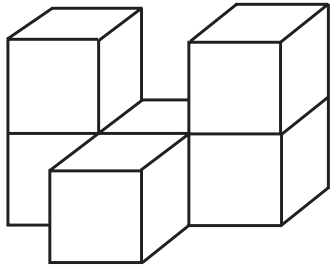

Ground plan

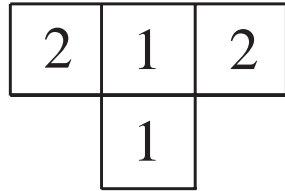

Front view

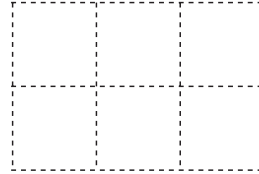

Top view

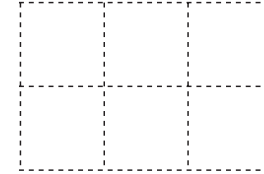

Right side view

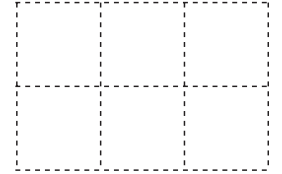

LP 166/6

a)

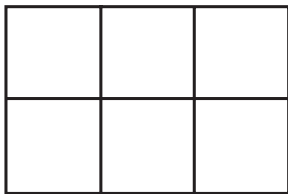
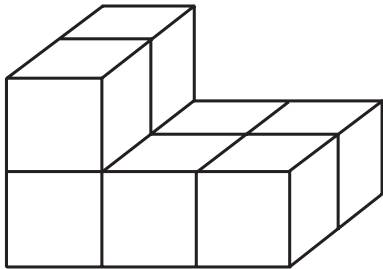

b)

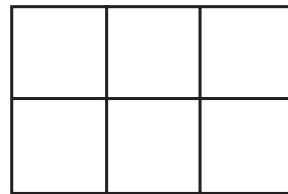
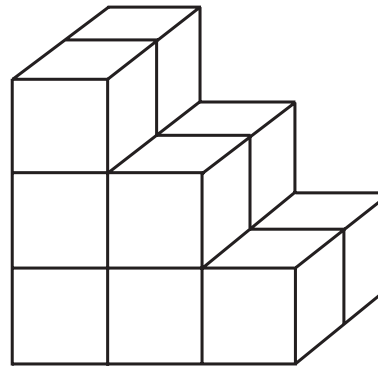

c)

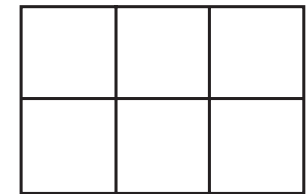
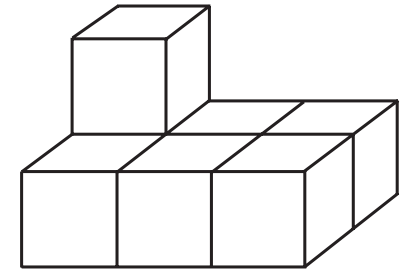

LP 166/7

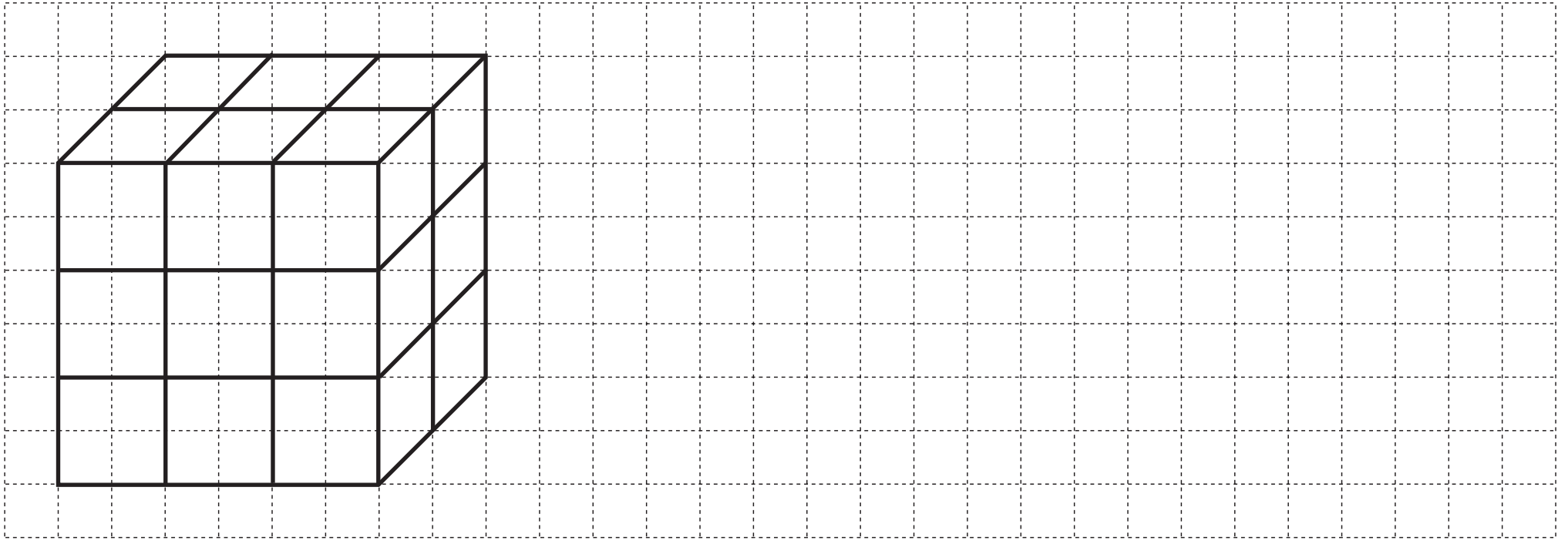

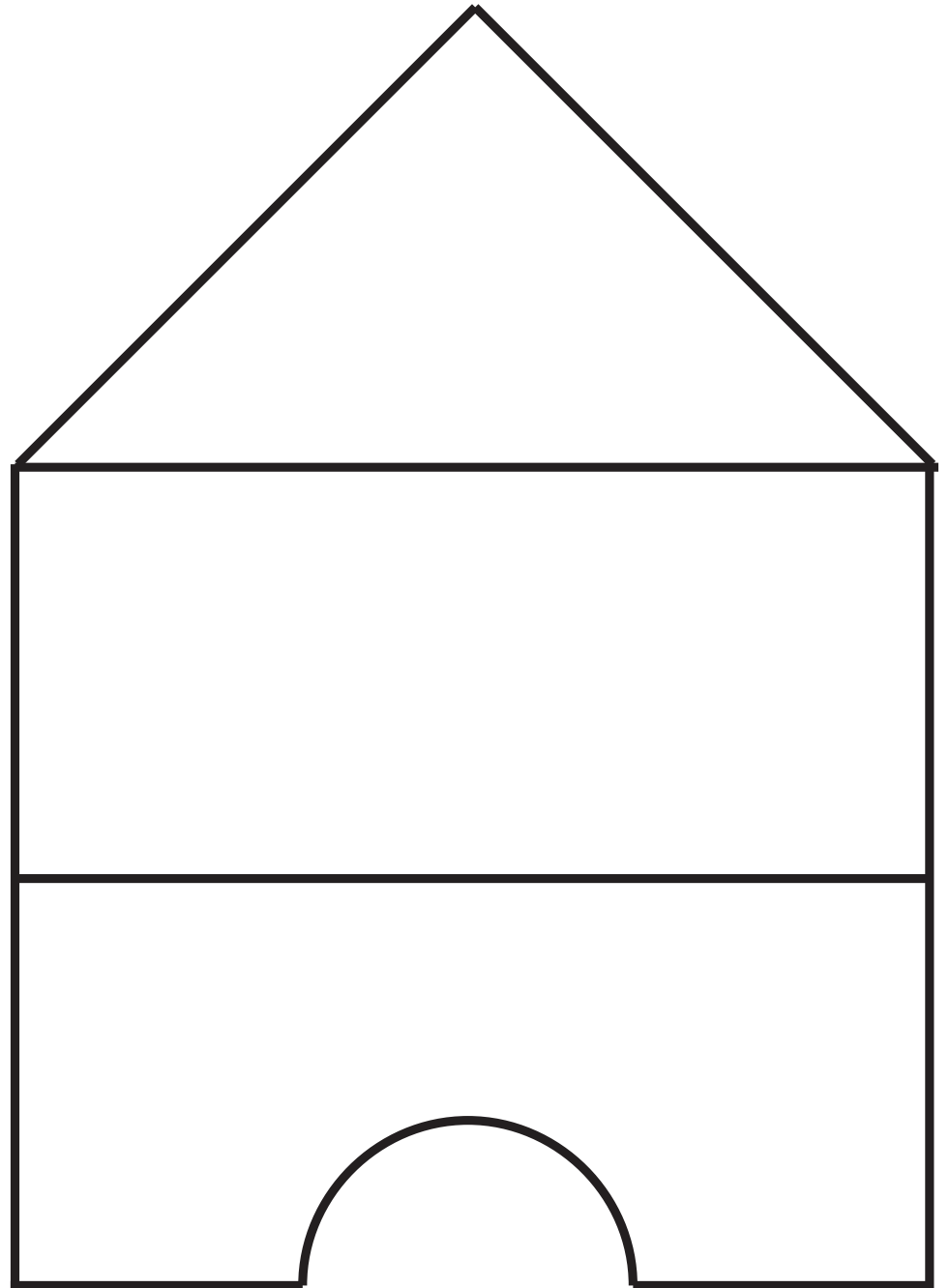
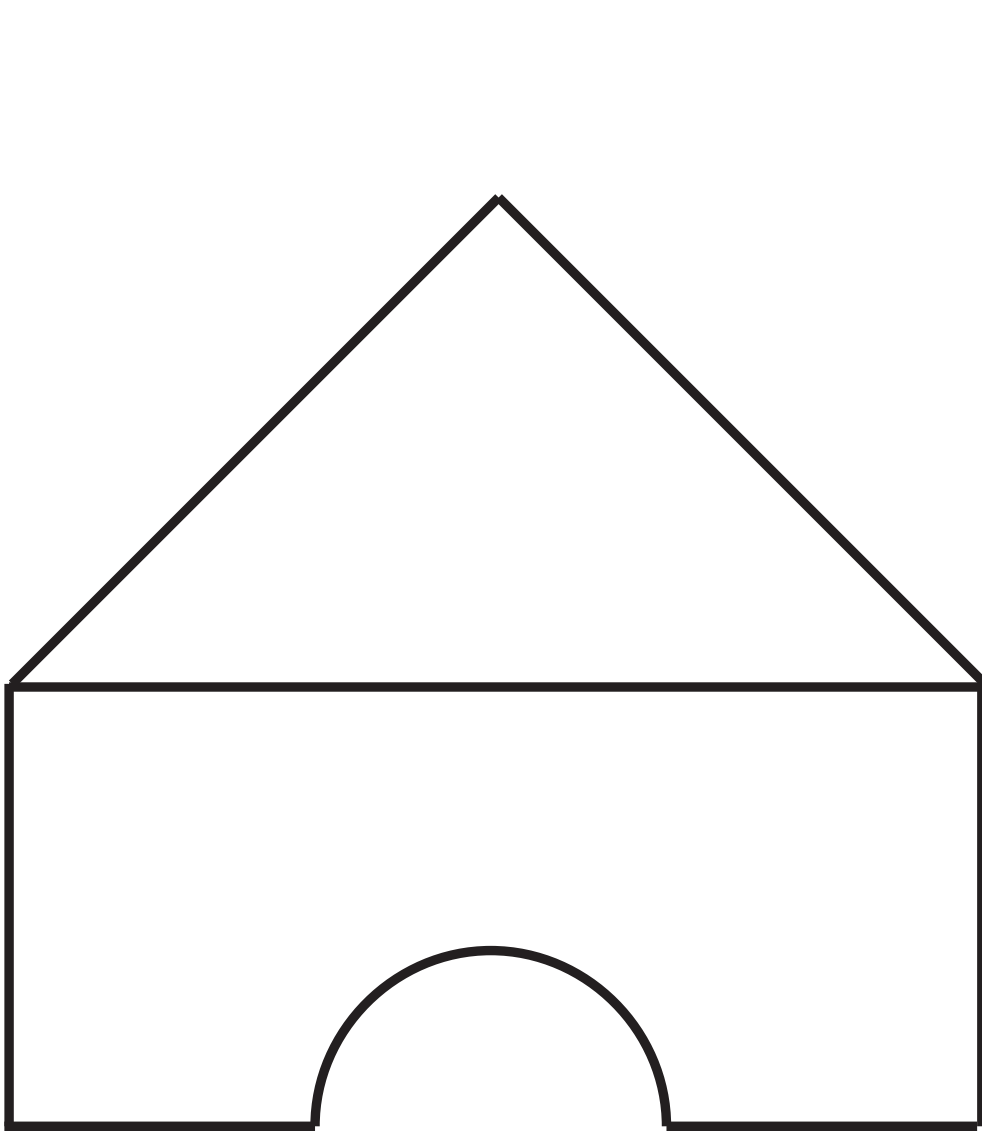

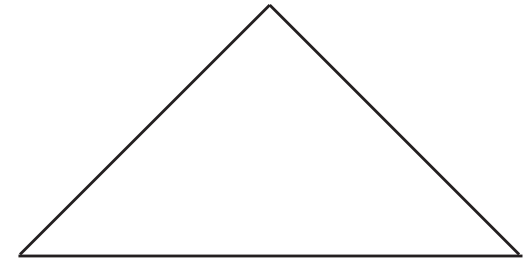
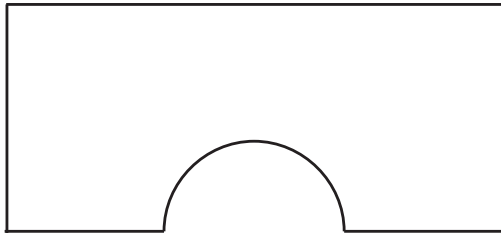
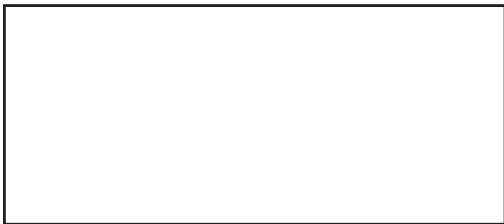
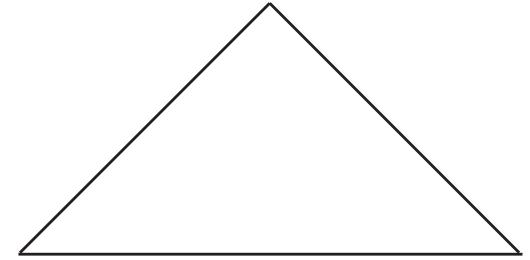
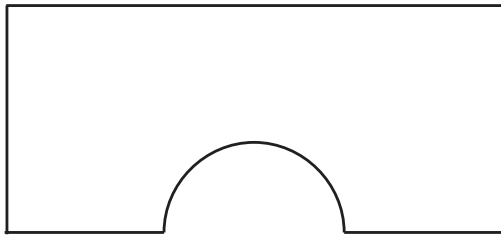
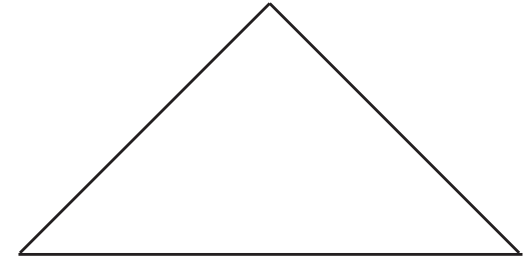
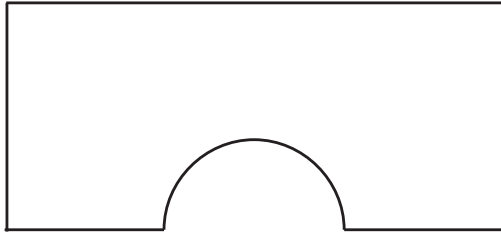
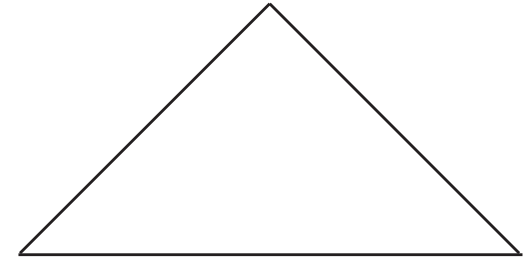
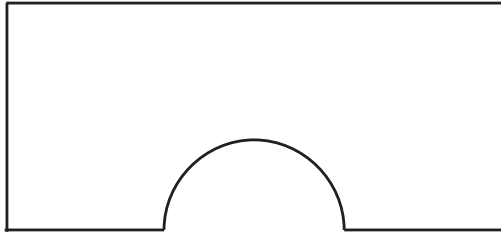
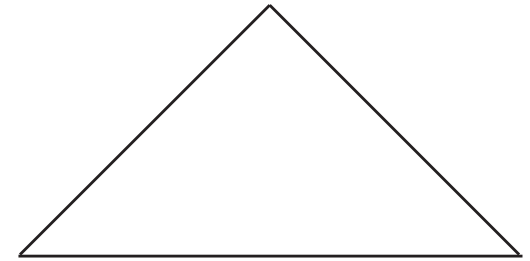
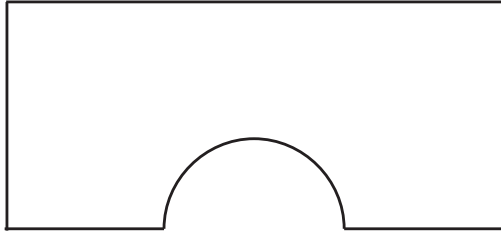

a)

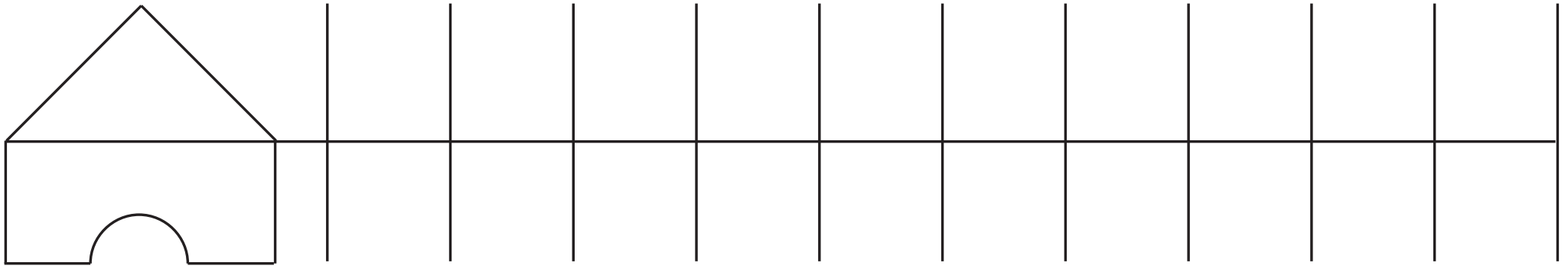

b)

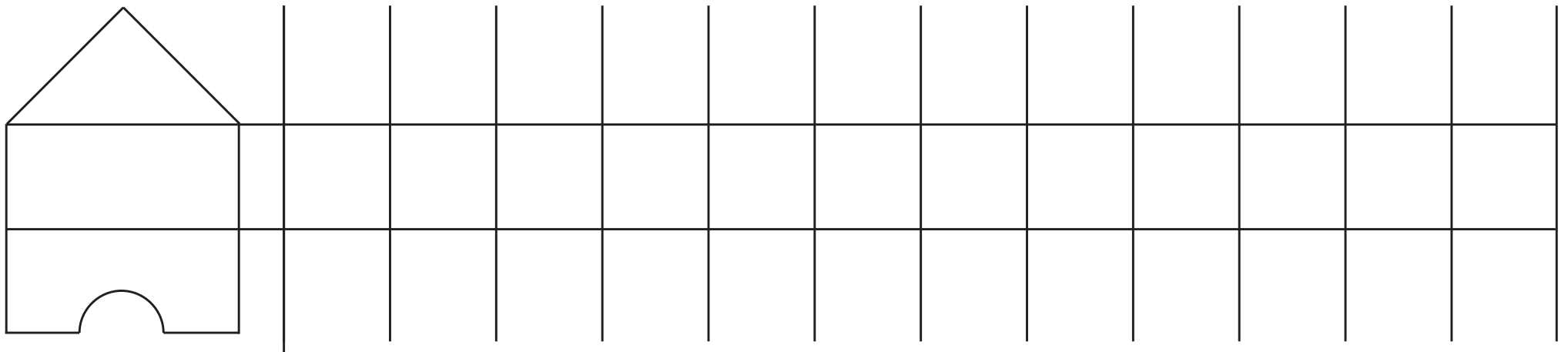

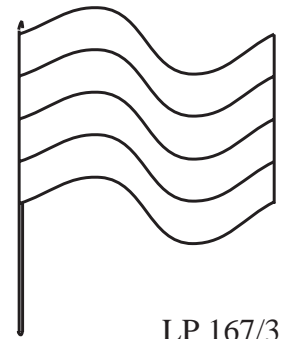
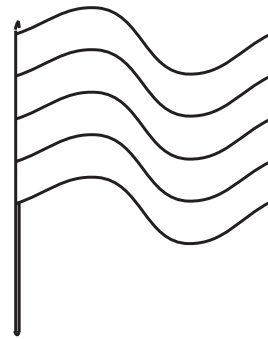
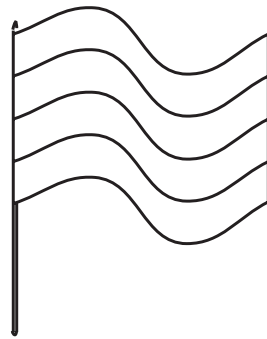
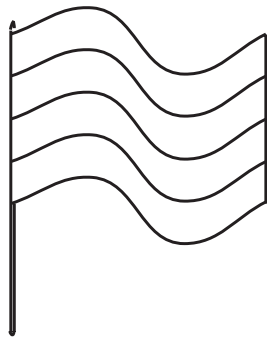
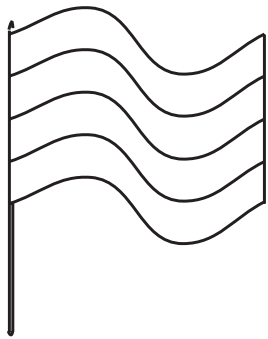
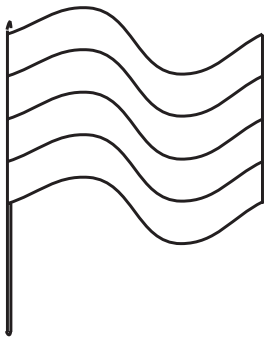
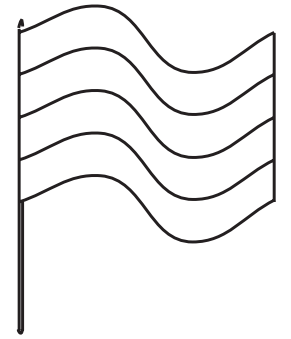
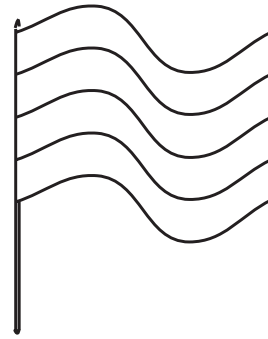
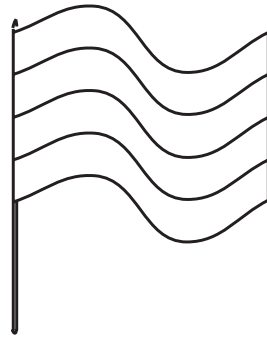
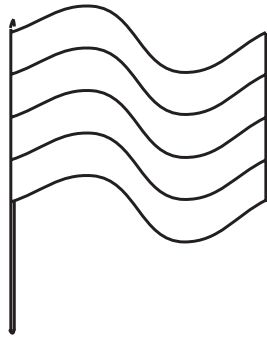
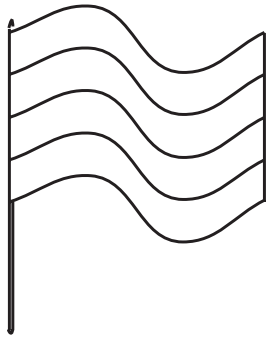
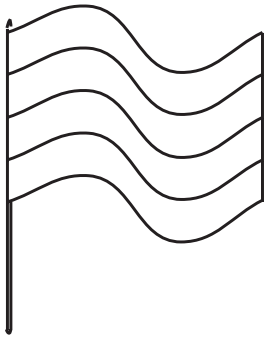

LP 167/3

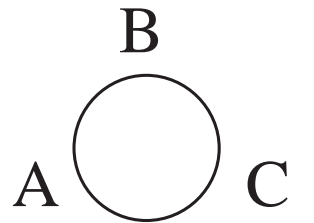
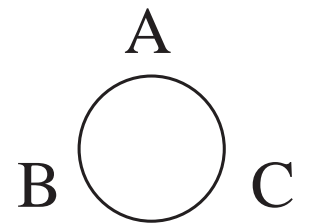
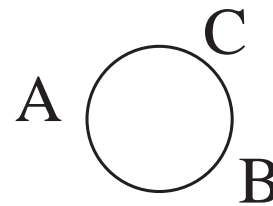
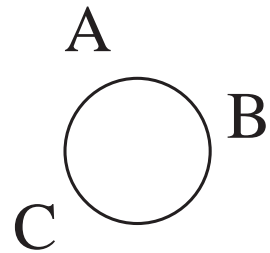
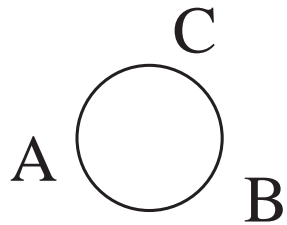
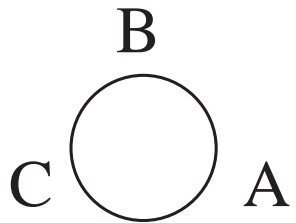

LP 167/4



--	--	--	--	--	--	--	--	--	--

LP 167/5

A	C																		
B	D																		
	E																		

LP 167/6

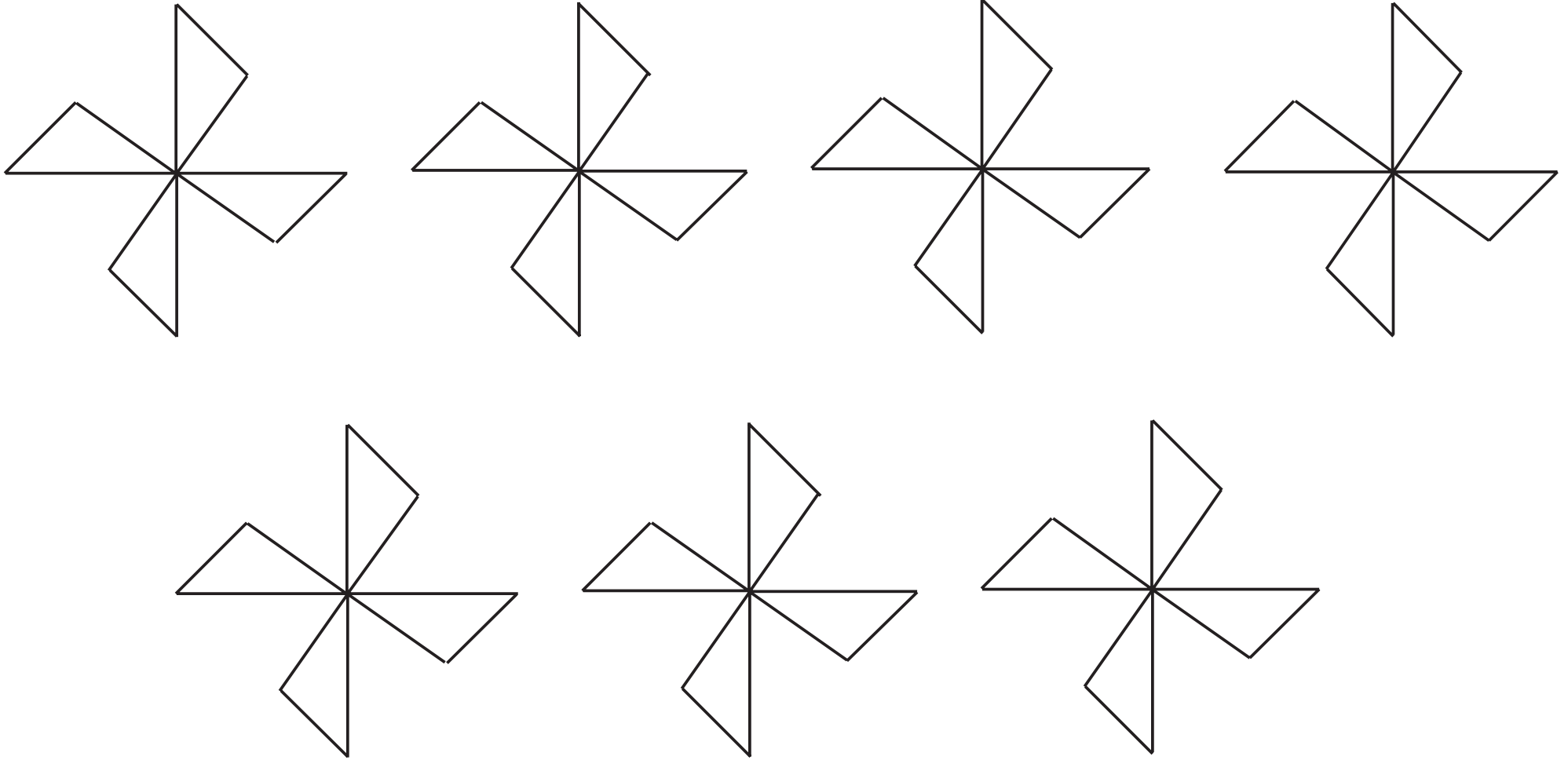

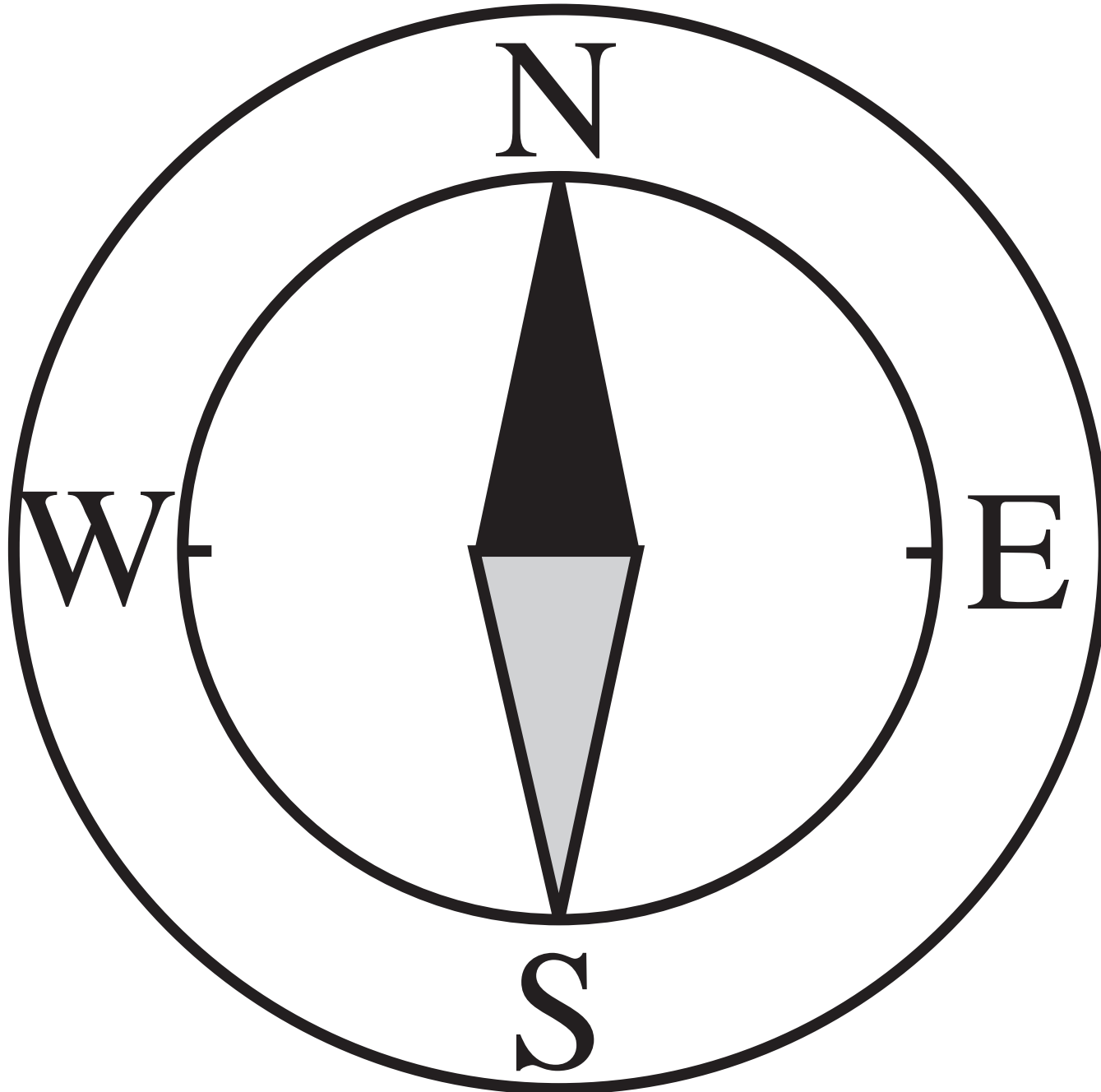



E I F L

I E F L

F E I L

L E I F

E I L F

I E L F

.....

.....

.....

.....

.....

.....

.....

.....

.....

.....

.....

.....

.....

.....

.....

.....

.....







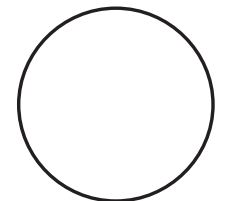
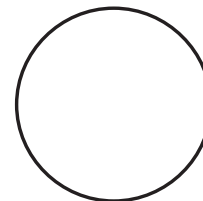
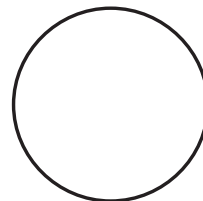
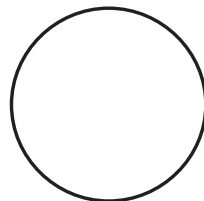
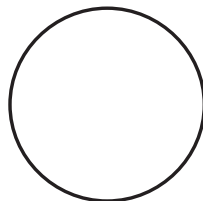
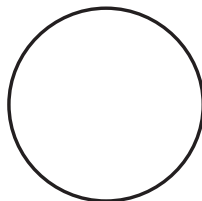
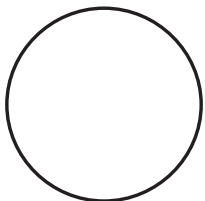
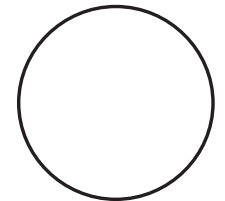
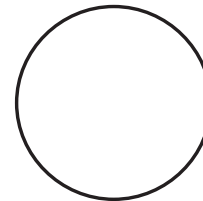
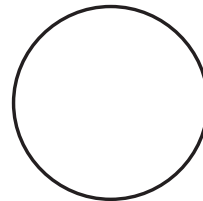
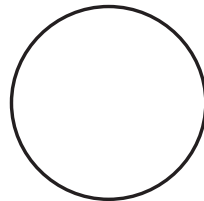
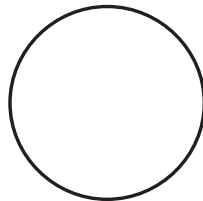
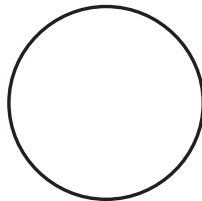
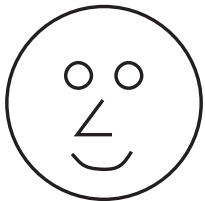

.....

Eyes: ○ ○ or ∪ ∪

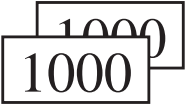
Nose: ∟ or ∆

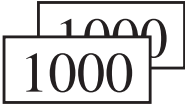
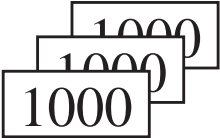
Mouth: ∪ or ∩ or —

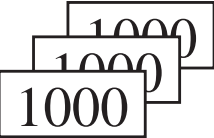
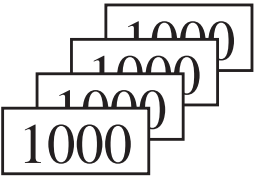

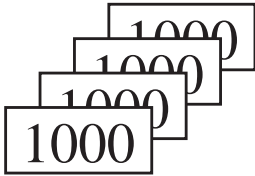
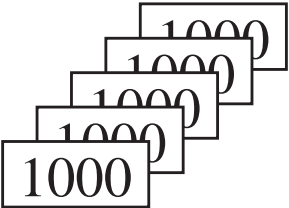
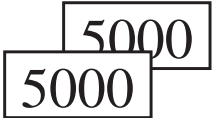
	-----	 	-----
	-----	 	-----
	-----	 	-----
	-----	 	-----
	-----		-----

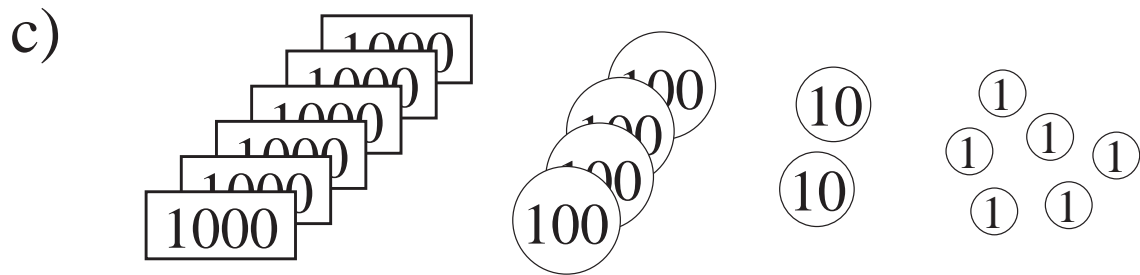
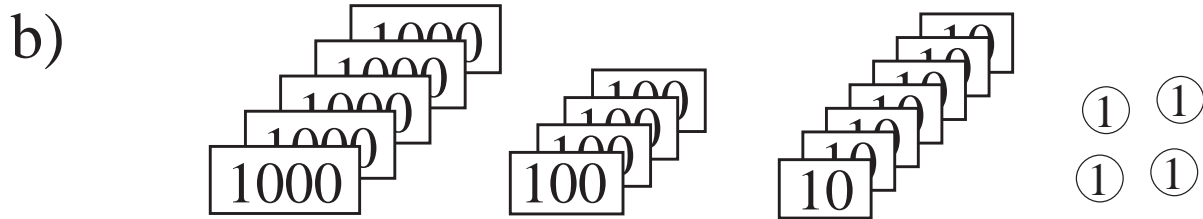
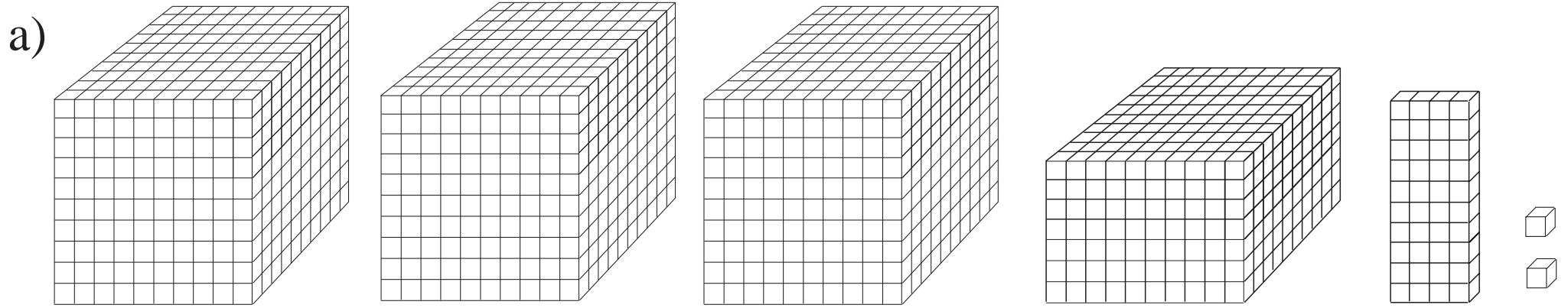

a)

Th	H	T	U

b)

c)

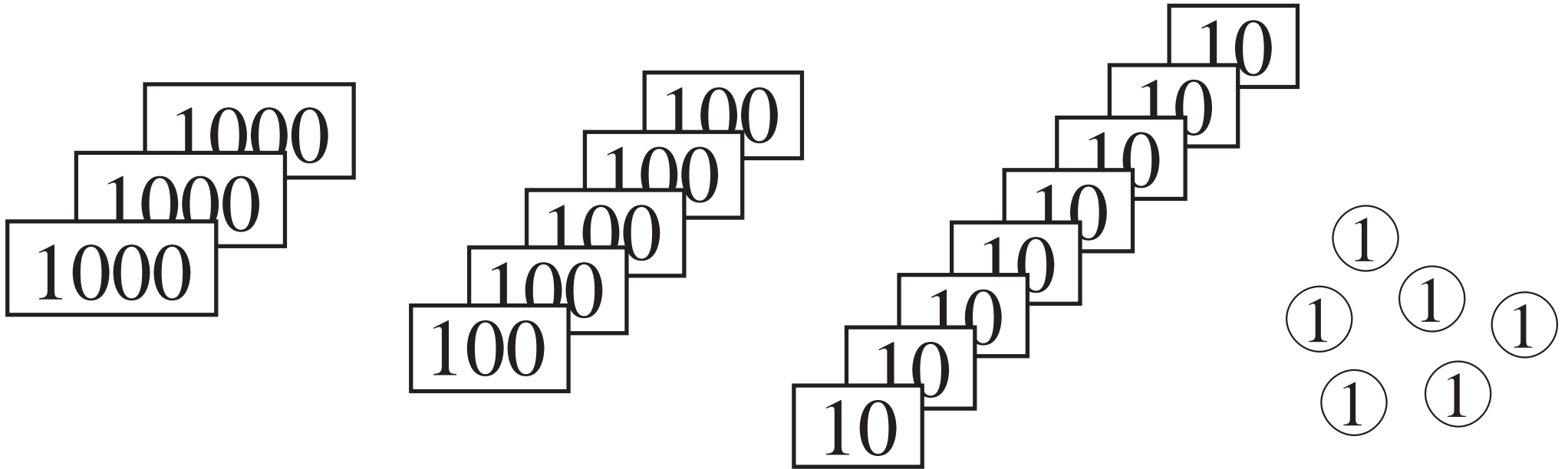

Th	H	T	U

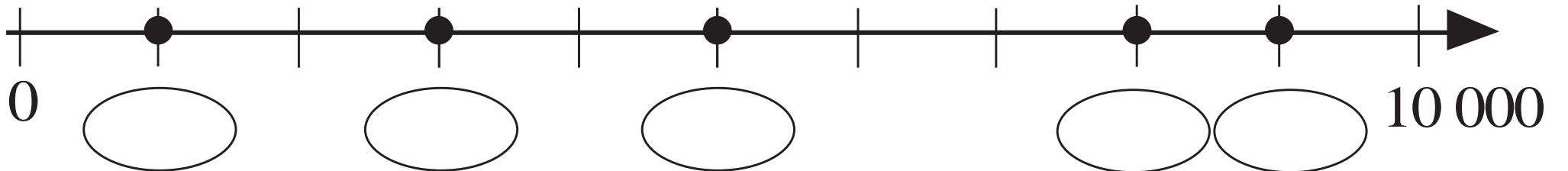
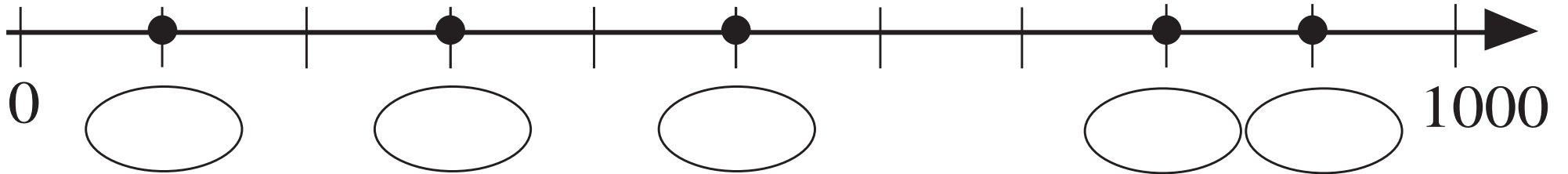
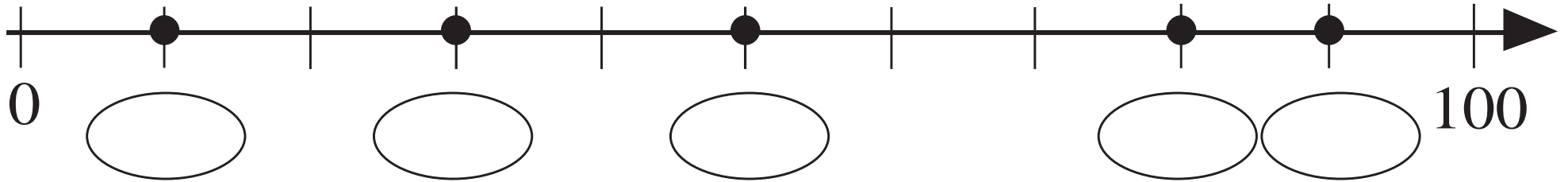
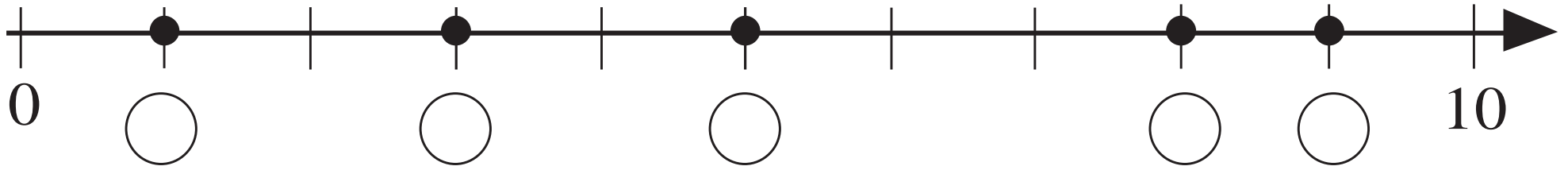

1500

930

1780

1100

1355



5500

4930

5780

5100

5355

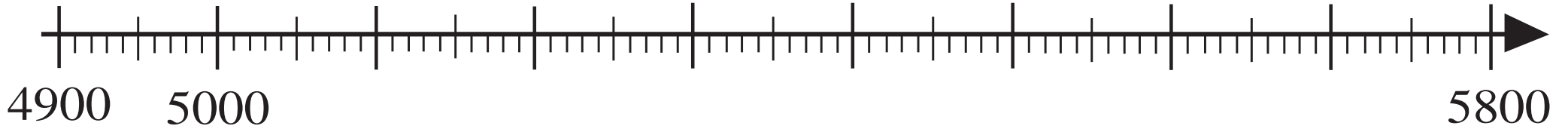

	Th	H	T	U	Number
2 thousands + 6 hundreds + 3 tens + 8 units					
7 thousands + 3 hundreds + 5 units					
$6 \times 1000 + 3 \times 100 + 9 \times 10 + 7 \times 1$					
$4 \times 1000 + 0 \times 100 + 6 \times 10 + 4 \times 1$					
$8000 + 500 + 40 + 9$					
$9000 + 50 + 4$					

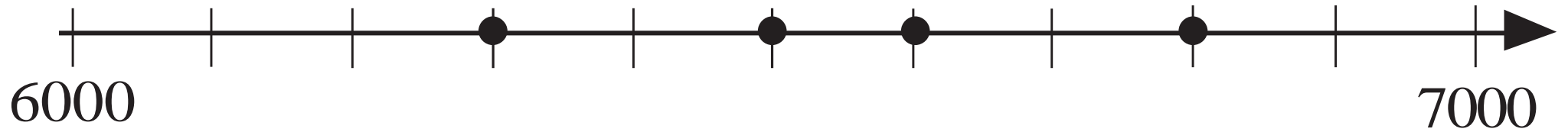
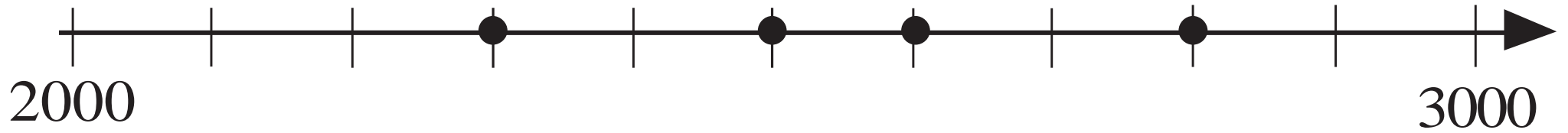
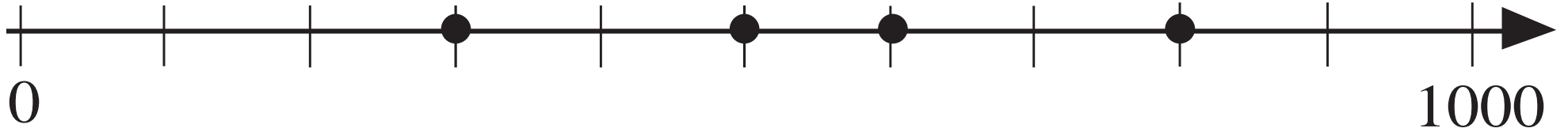

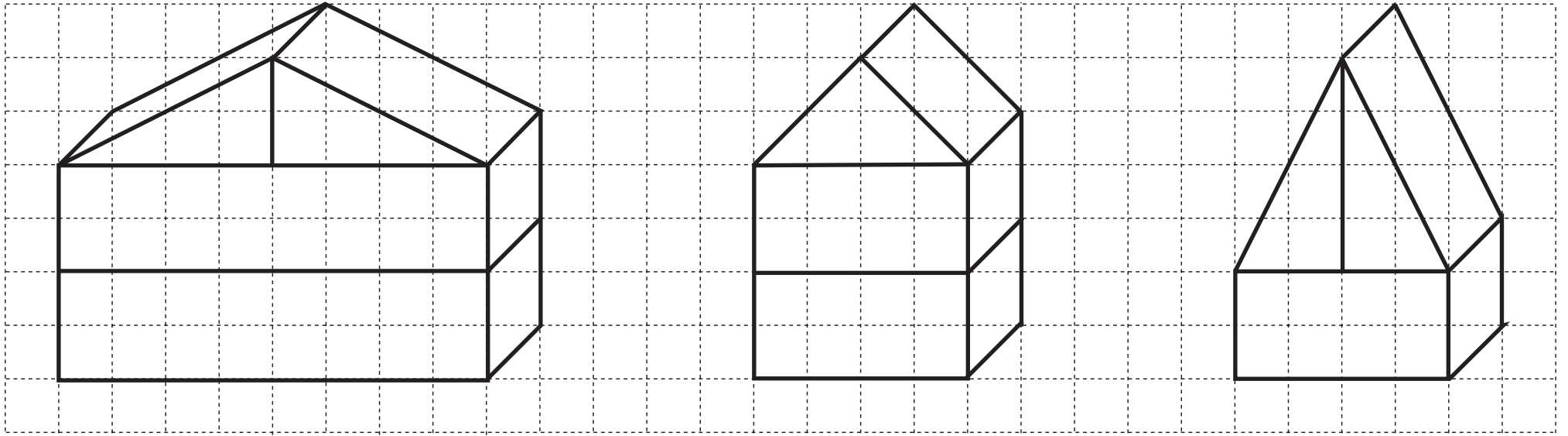

LP 170/1

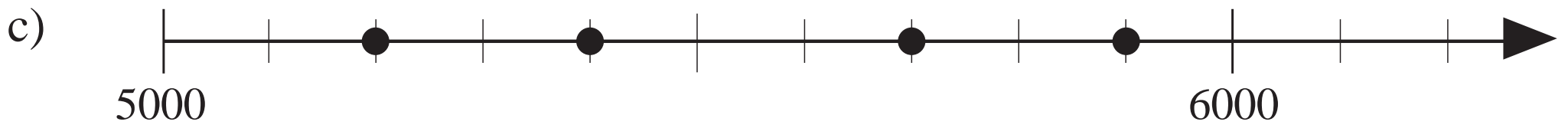
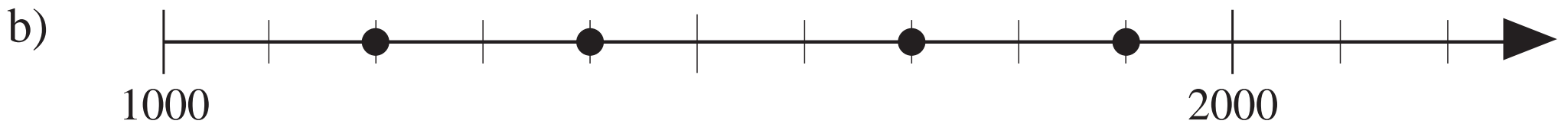
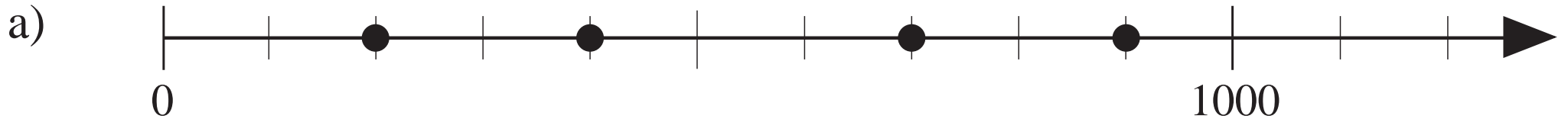

LP 170/5

Tenland

1000	100	10	①
			7
			8
			9
		1	1
		2	7
	1	0	0
	1	2	1

Nineland

729	81	9	①
		1	1
		3	3
1	0	0	1
1	0	2	8



Tenland

1000	100	10	①
			1
			2
			3
			4
		1	5

→

→

→

→

←

←

→

←

←

←

←

Twoland

256	128	64	32	16	8	4	2	①	
							1	0	1
						1	0	0	1
					1	0	0	0	0
					1	1	1	1	0
1	0	0	1	0	1	0	0	0	1

<input type="text"/>	<input type="text"/>	<input type="text"/>	①

→

→

<input type="text"/>	<input type="text"/>	<input type="text"/>	①

→

→

<input type="text"/>	<input type="text"/>	<input type="text"/>	①

→

→

<input type="text"/>	<input type="text"/>	<input type="text"/>	①

→

→

<input type="text"/>	<input type="text"/>	<input type="text"/>	①

→

→

<input type="text"/>	<input type="text"/>	<input type="text"/>	①

→

→

a)

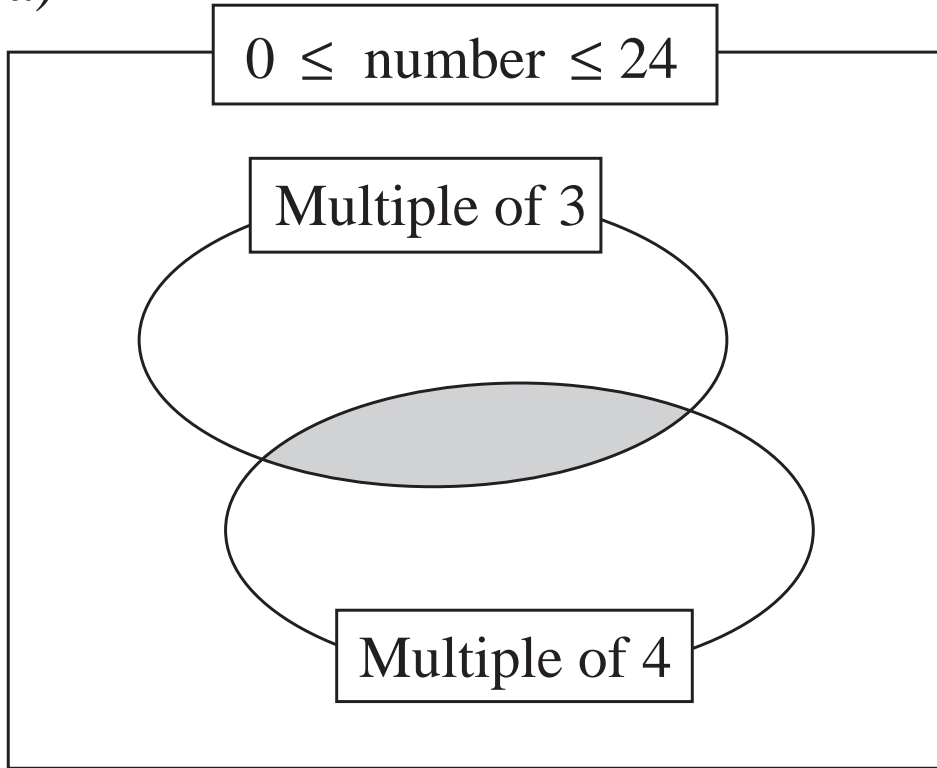

b)

	Multiple of 3	Not a multiple of 3
Multiple of 4		
Not a multiple of 4		

a)

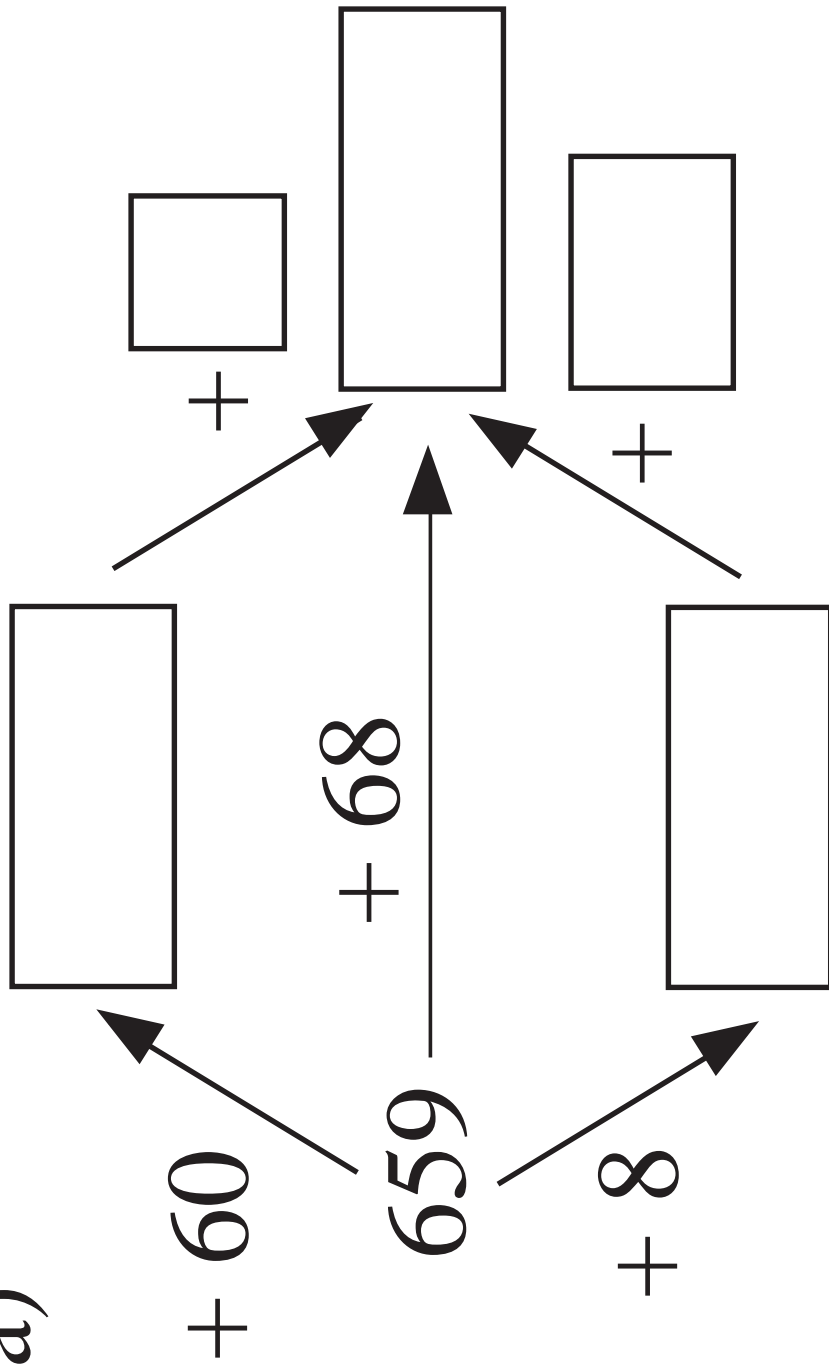

b)

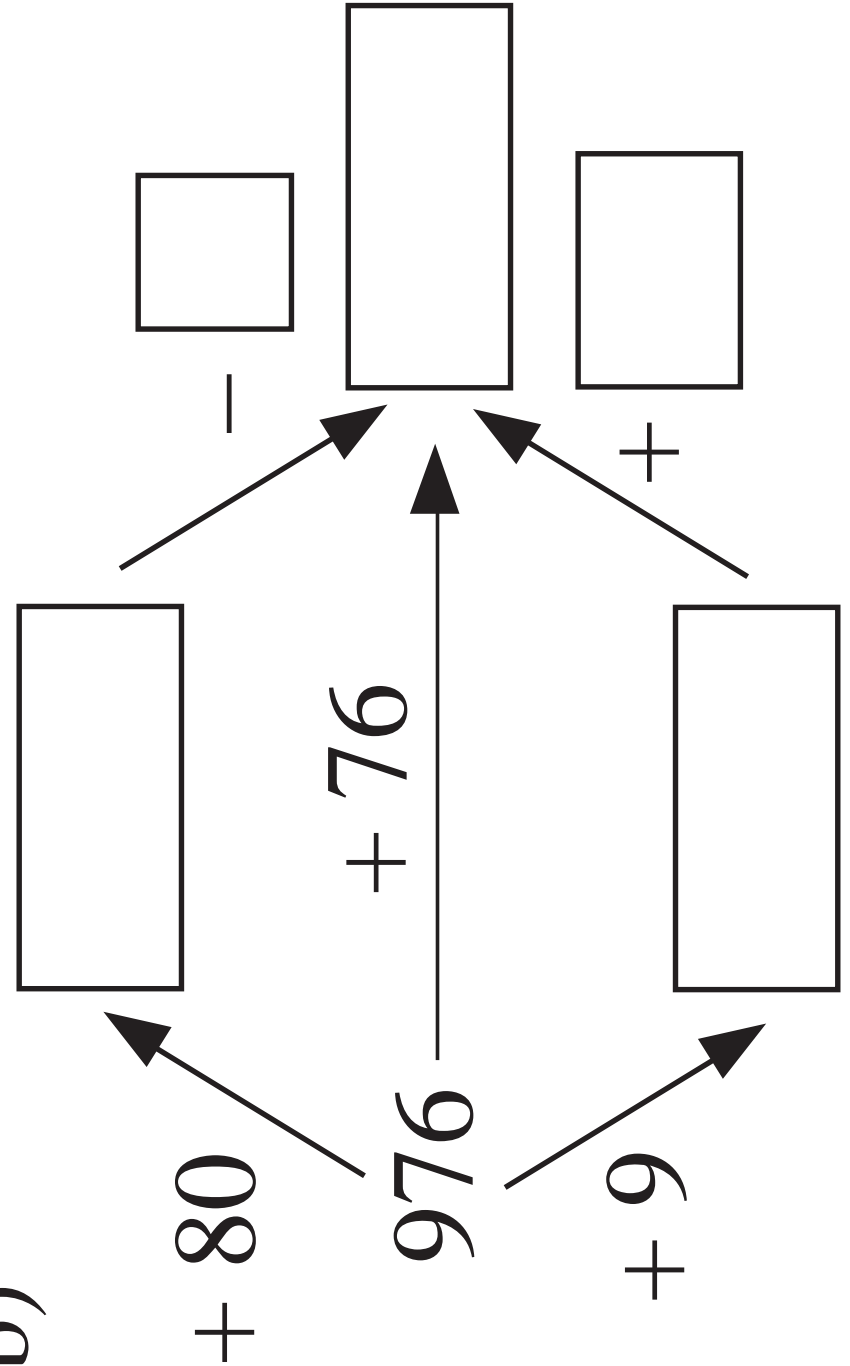

400	290	350	170	280	170
310	260	510	200	430	420
440	270	930	100	120	580
350	140	230	260	280	390

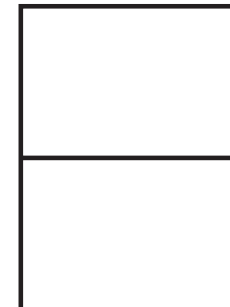
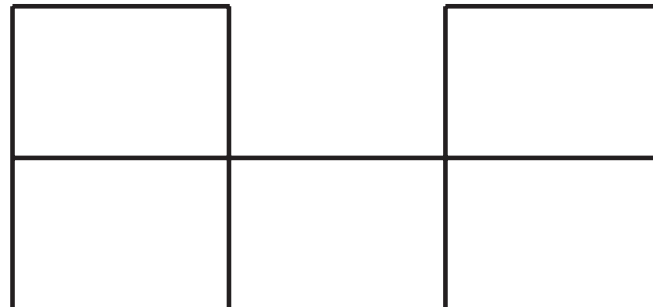
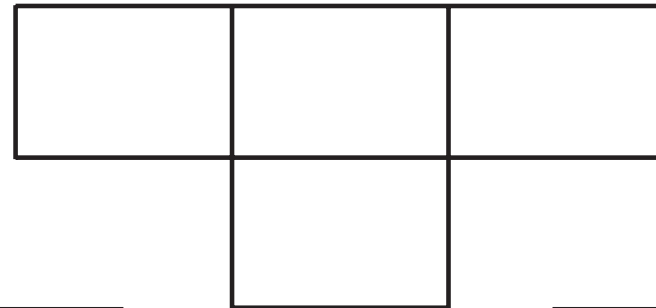
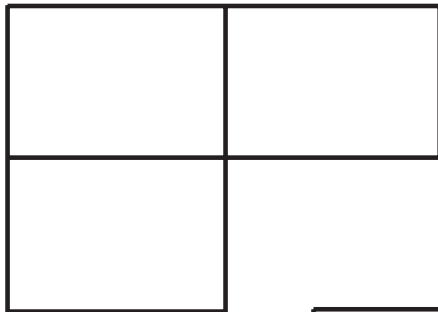

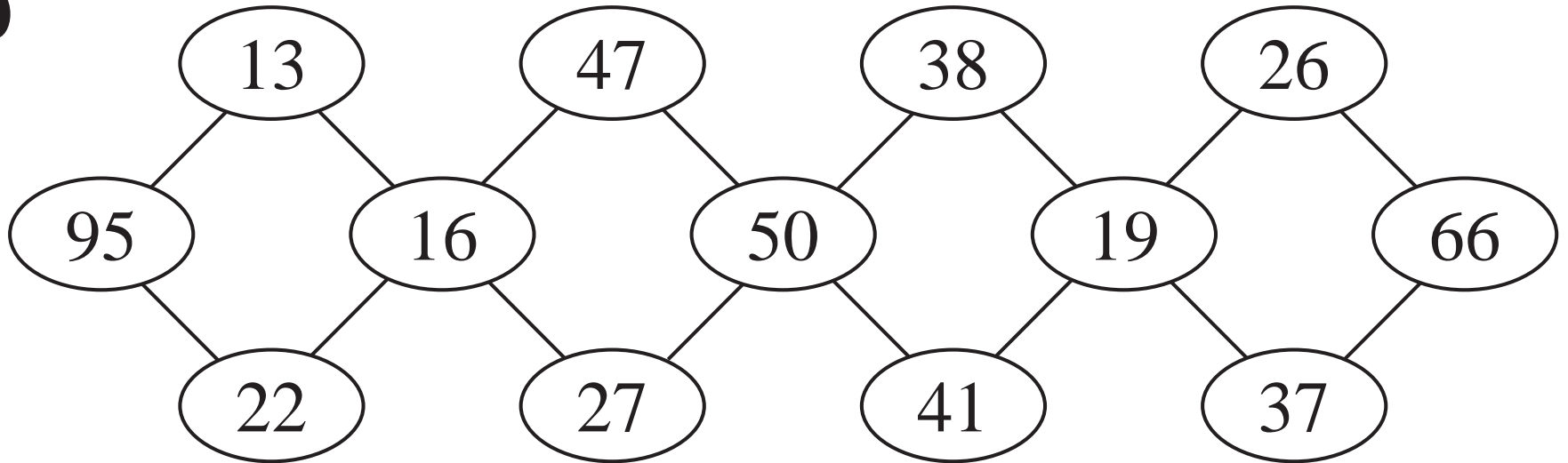
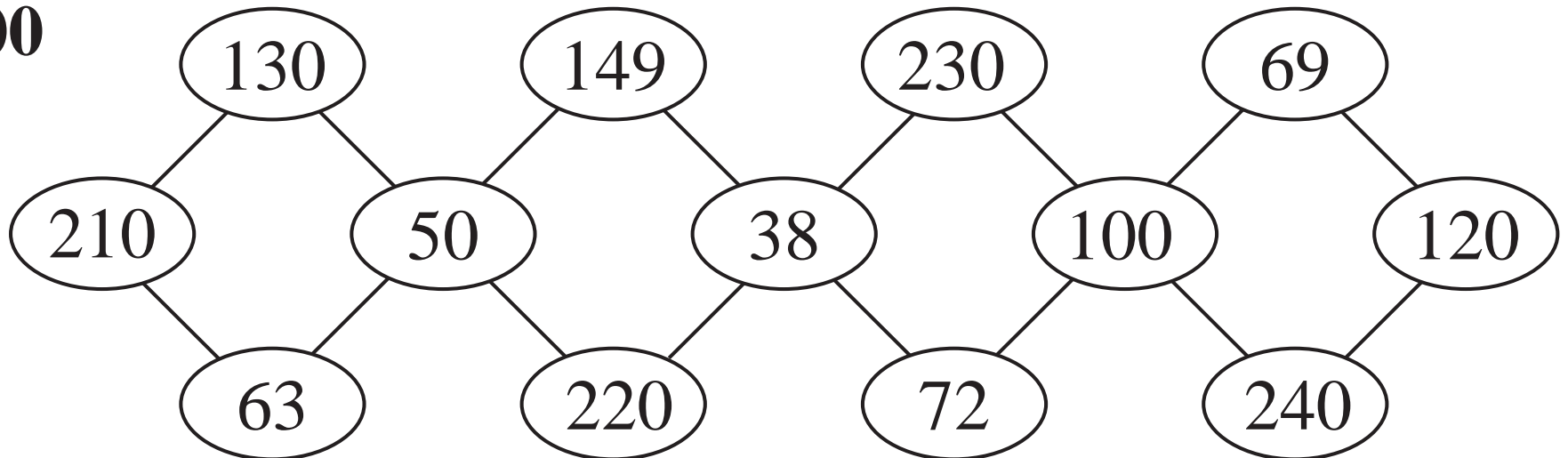
a) **350**b) **1200**

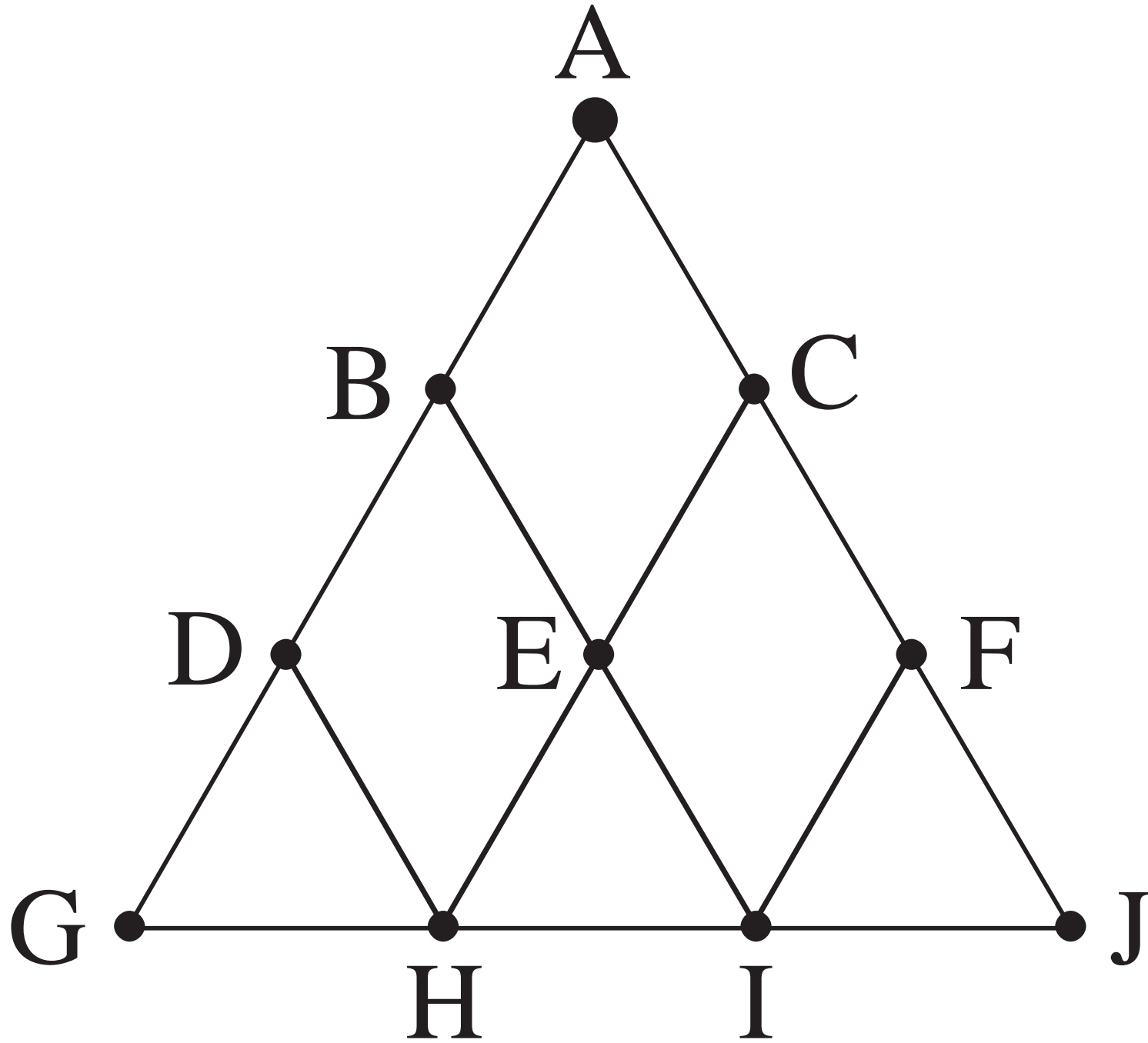

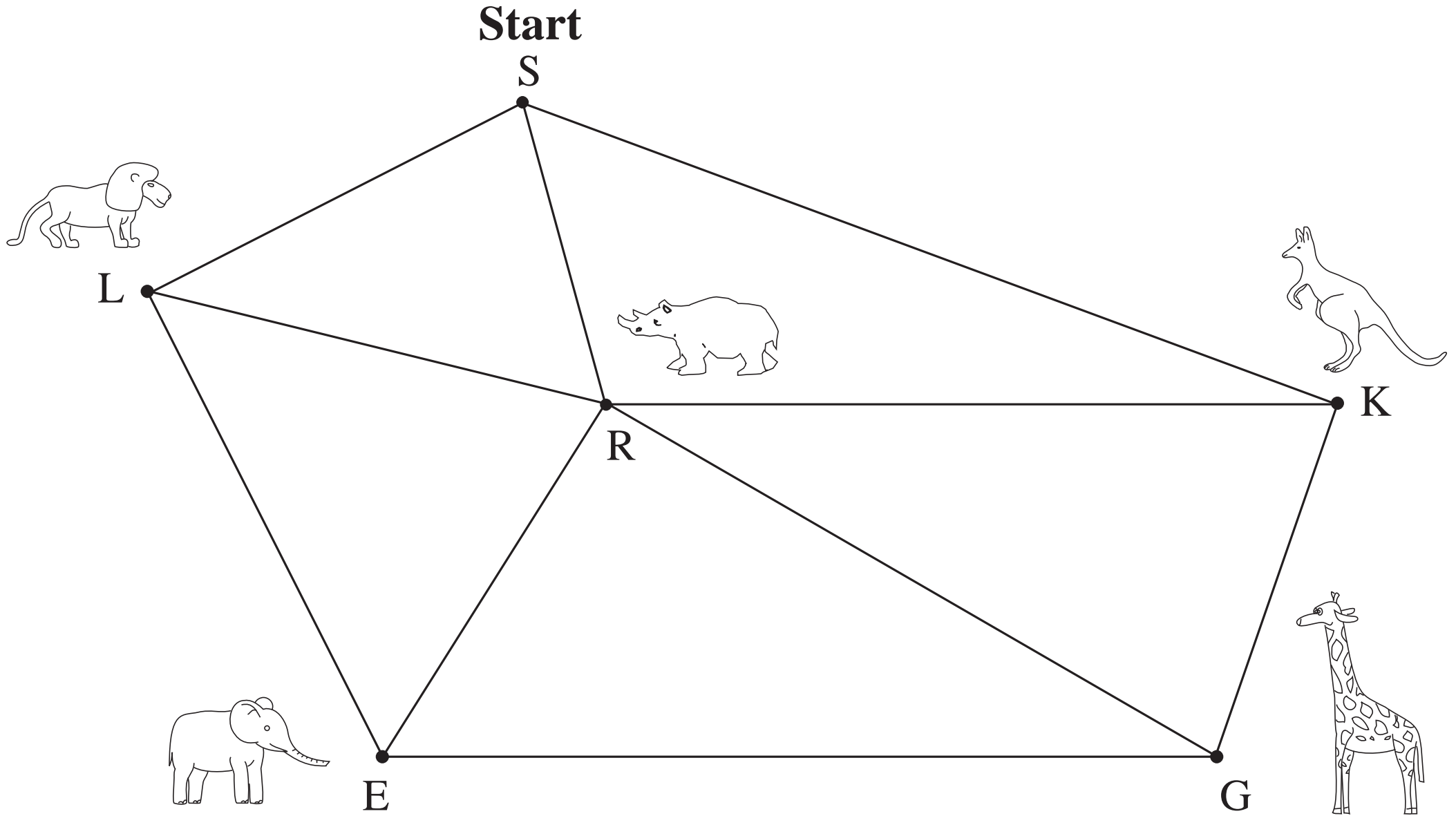

- a) 420, 400, 520,
540, 560, 580

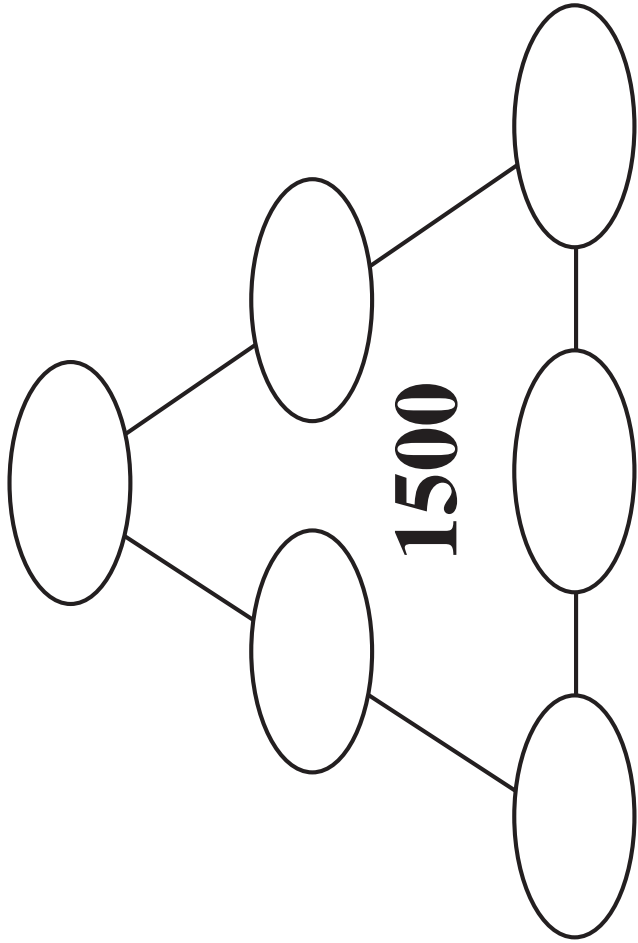

- b) 540, 560, 580, 480,
500, 520, 400, 460

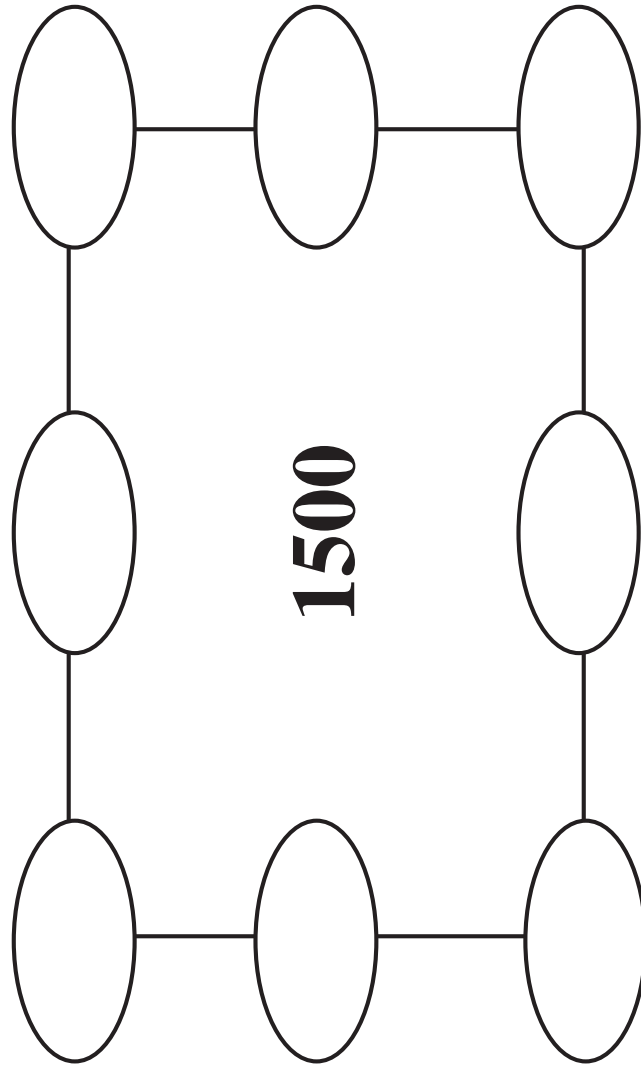

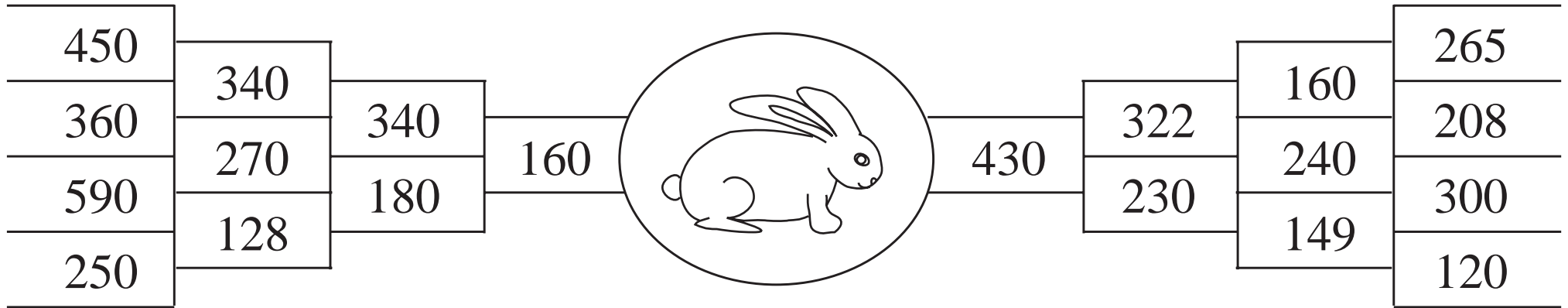

LP 174/3

a)

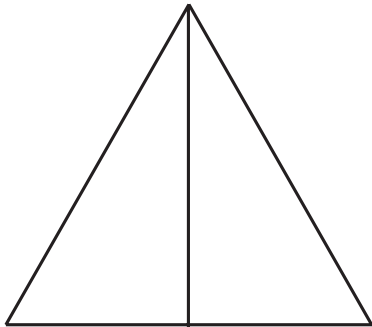

b)

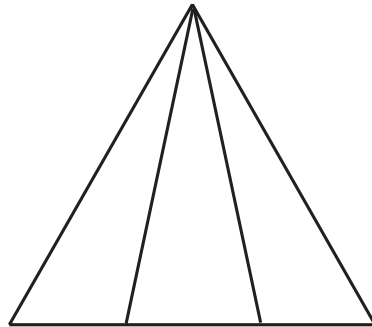

c)

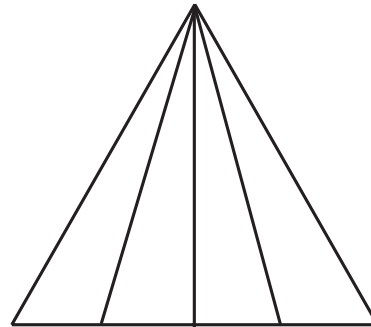

d)

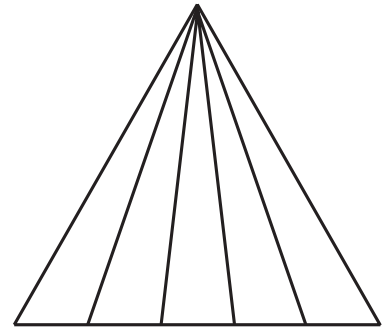

LP 174/8

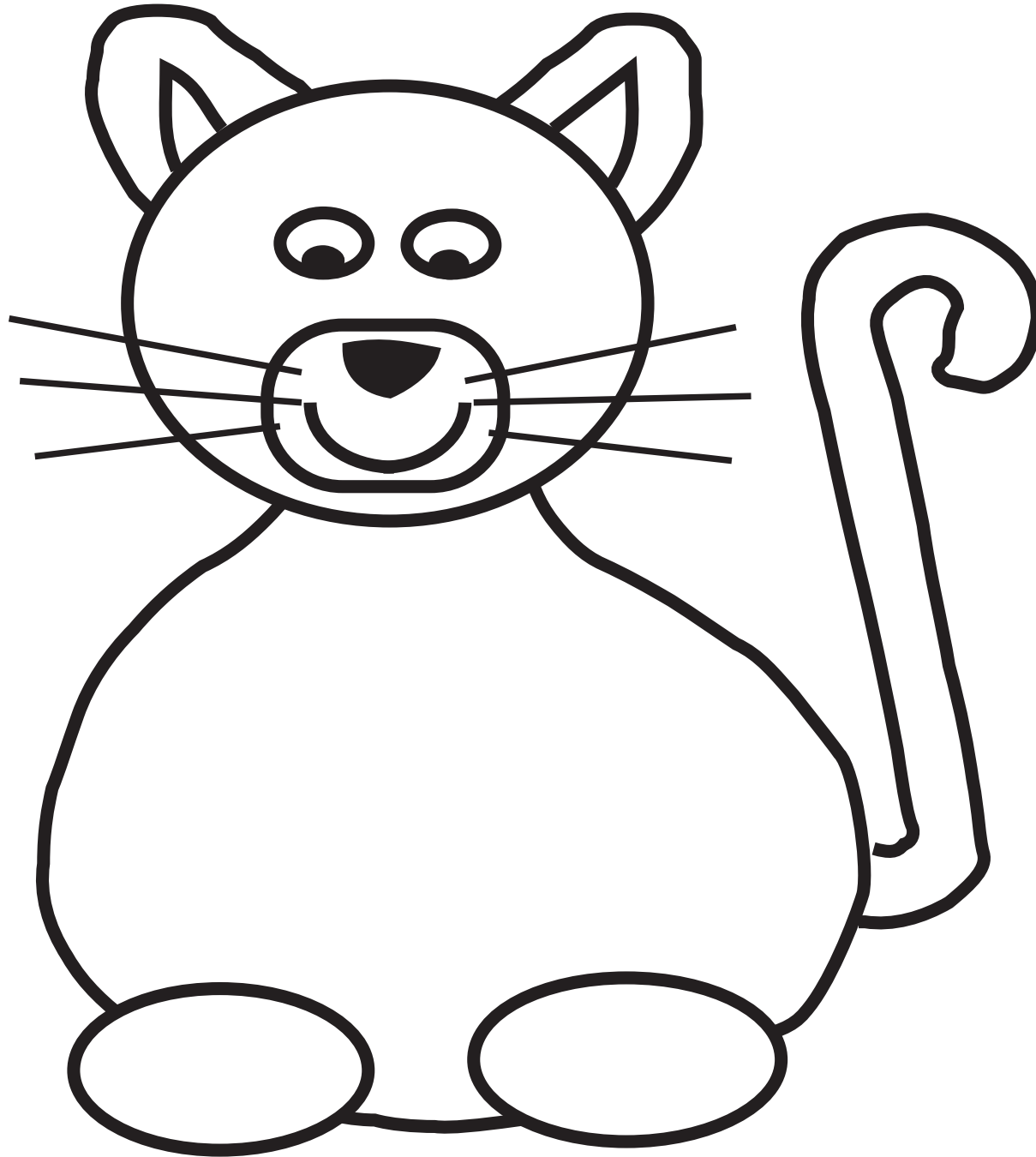

a)

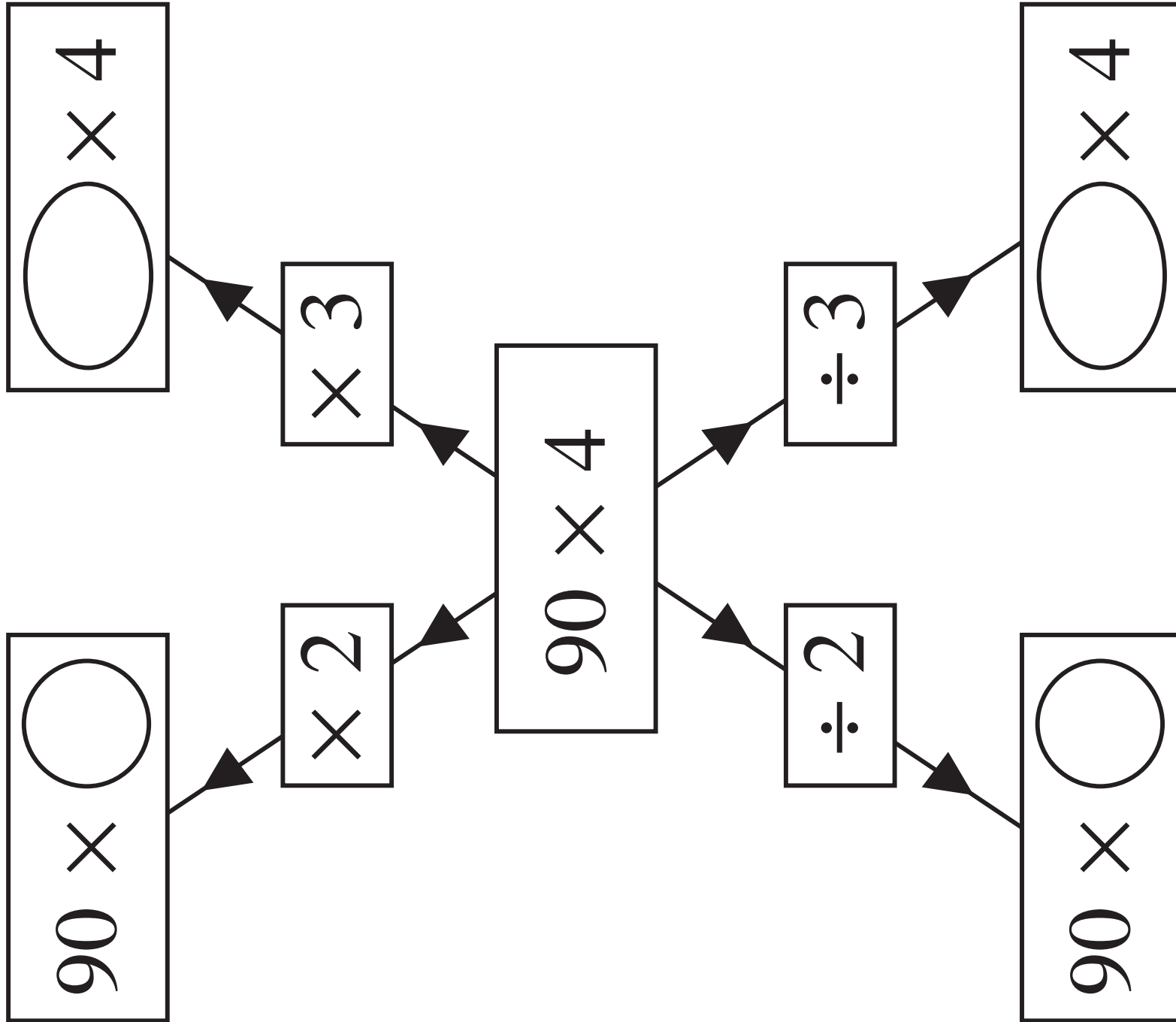

b)

