

$$\alpha = 2 \text{ r. a.} \quad \beta = \frac{1}{2} \text{ r. a.} \quad \gamma = 1.5 \text{ r. a.}$$

$$\delta = 3 \text{ r. a.} \quad \varepsilon = 3.5 \text{ r. a.}$$

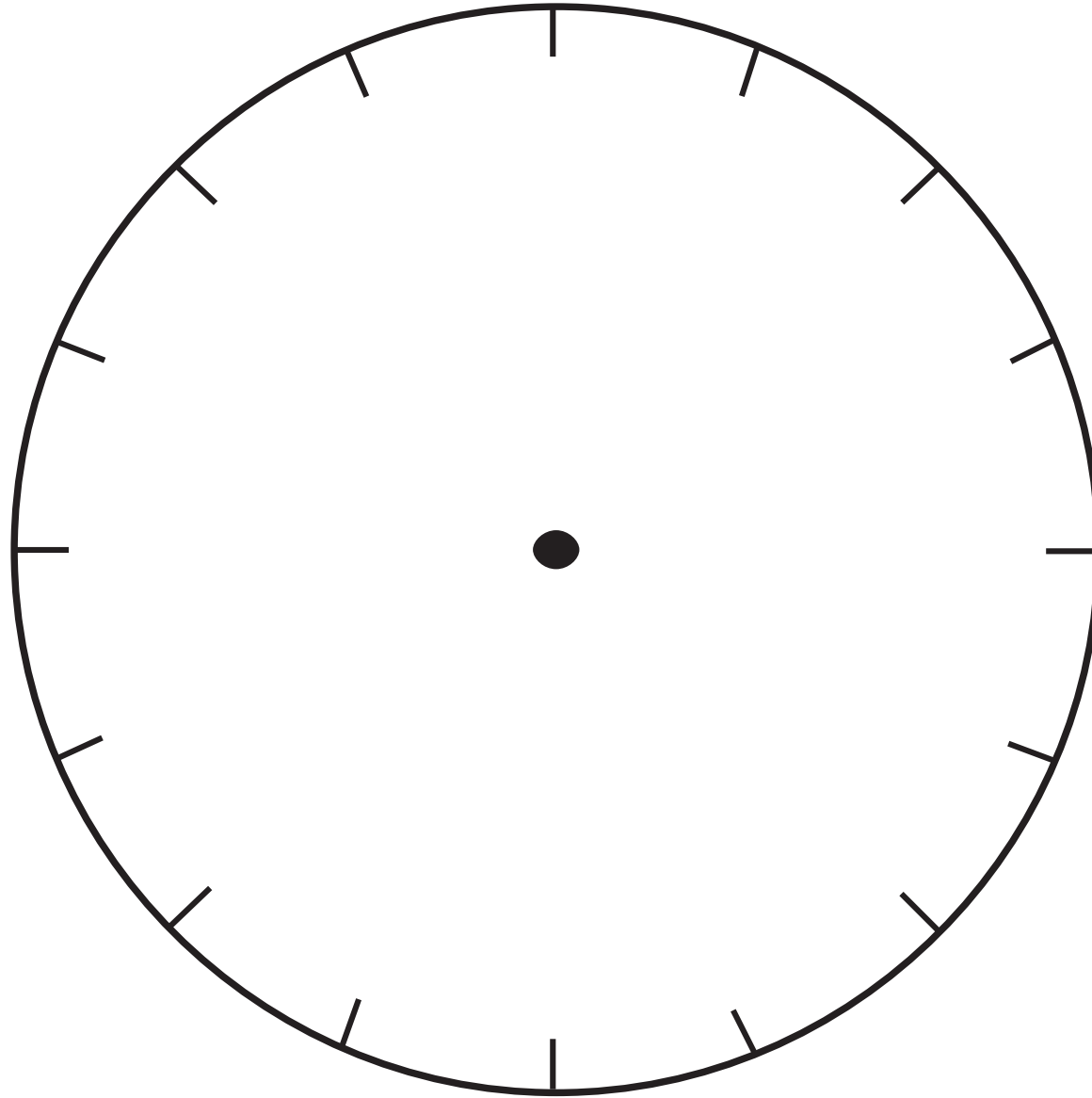

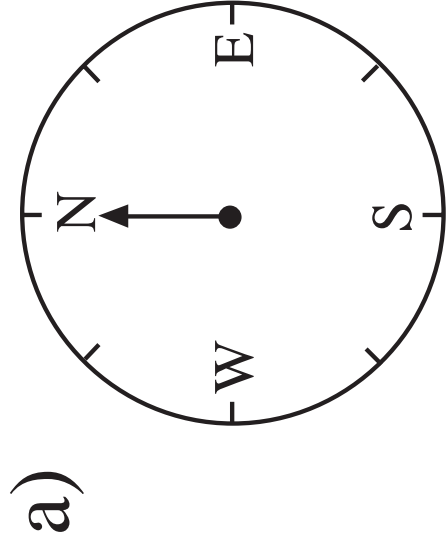

3 right angles
clockwise

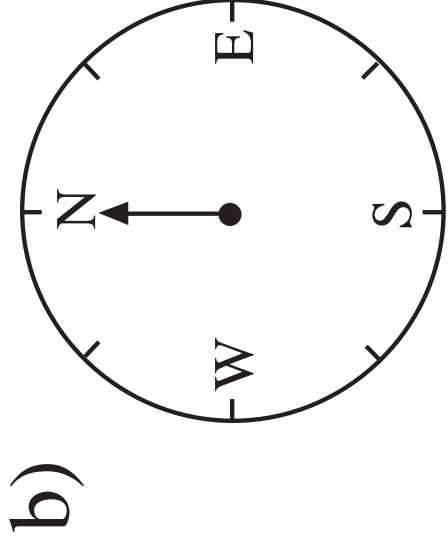

2 right angles
anti-clockwise

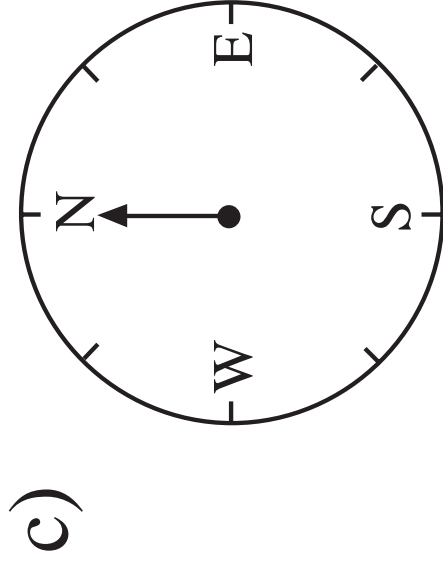

half a right angle
clockwise

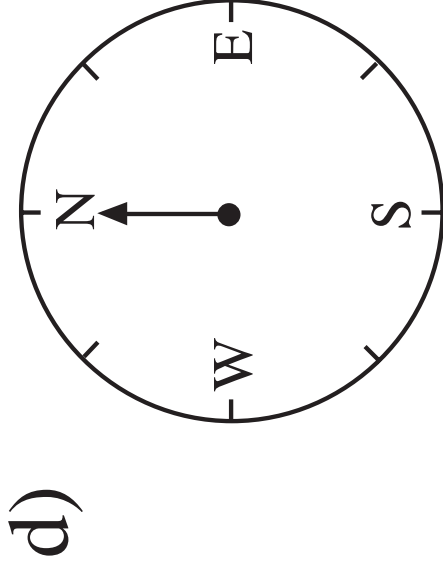

3 and a half
right angles
anti-clockwise

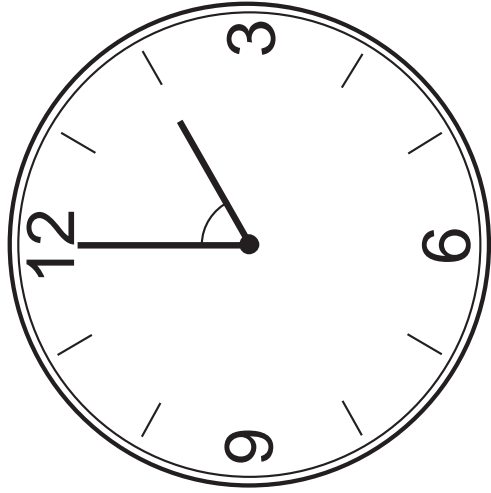

b)

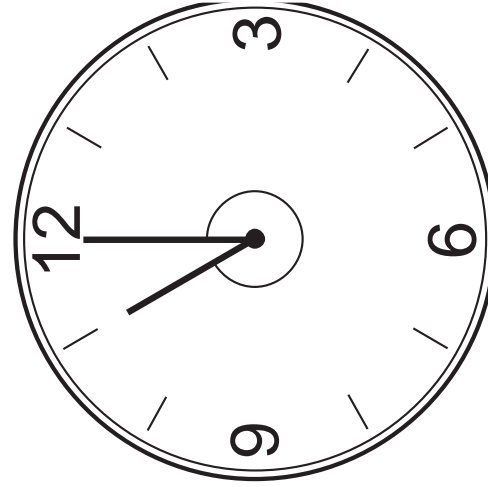

d)

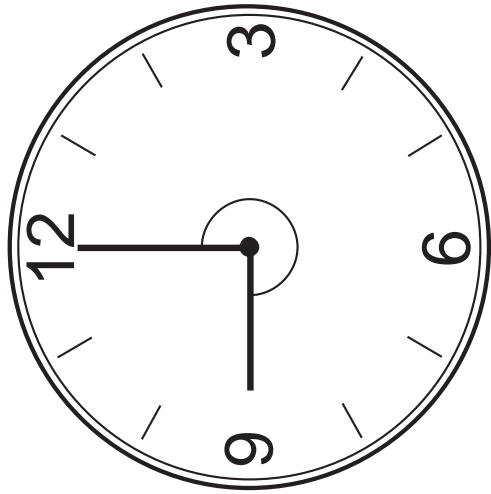

a)

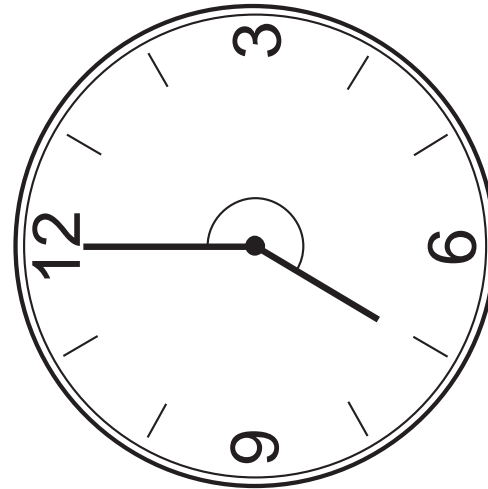

c)

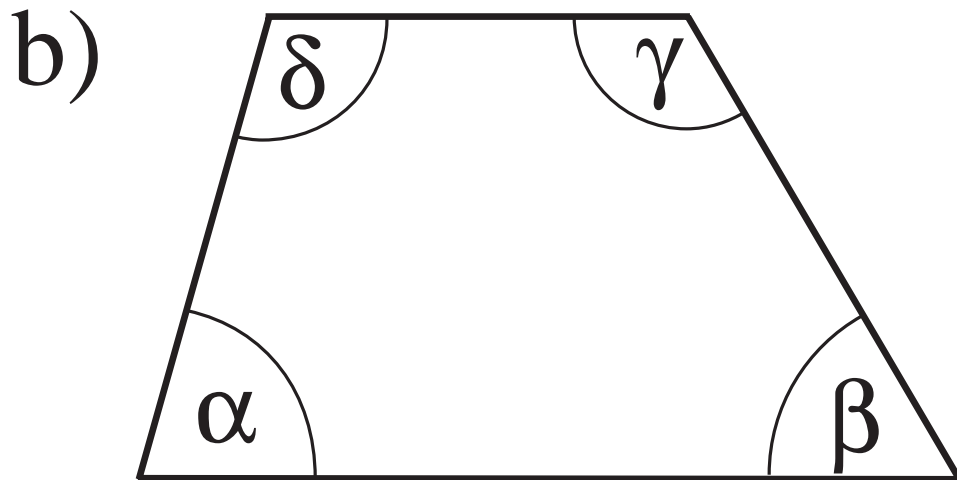
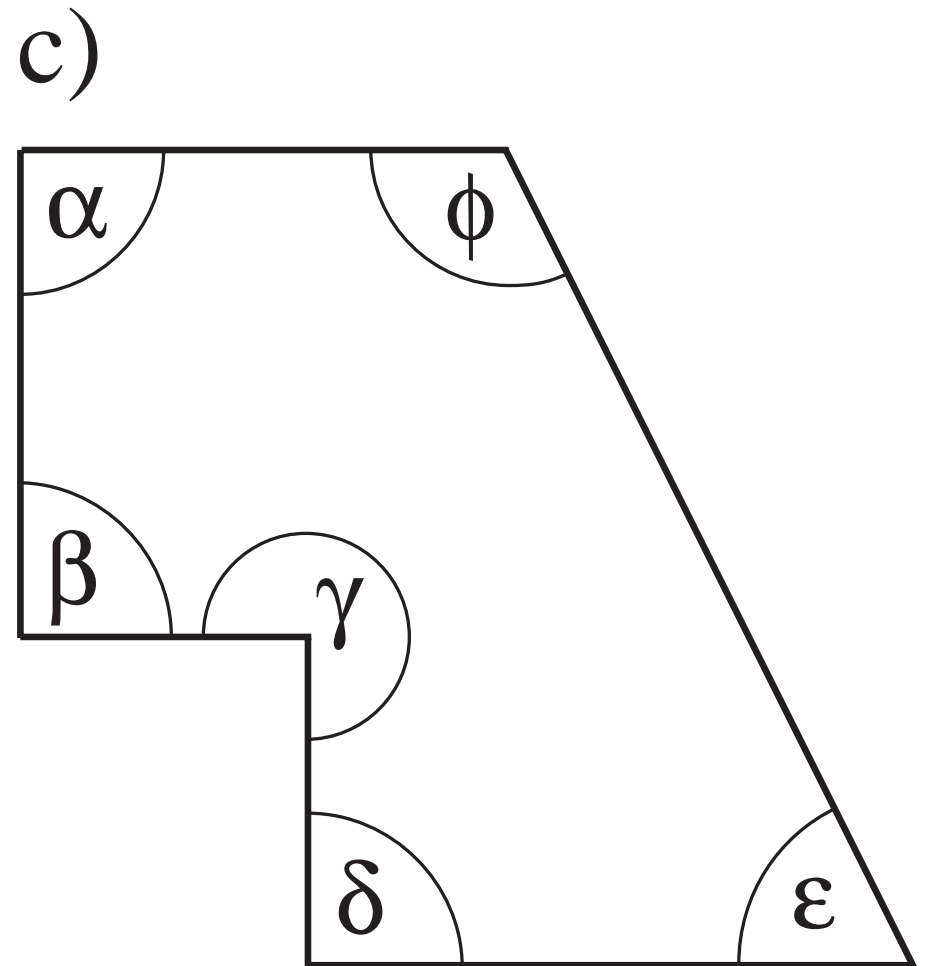
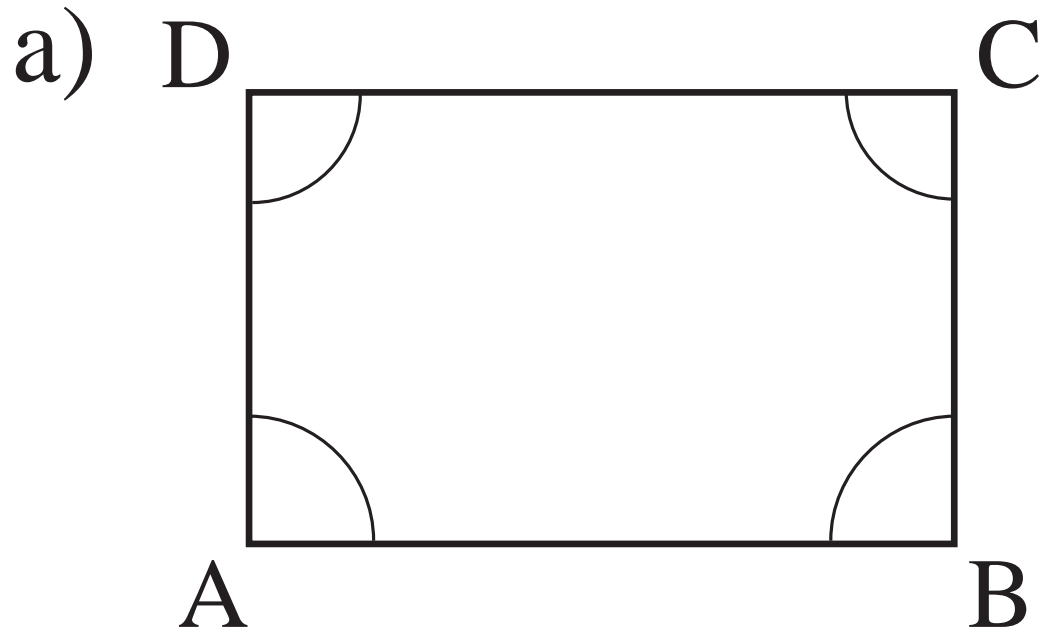

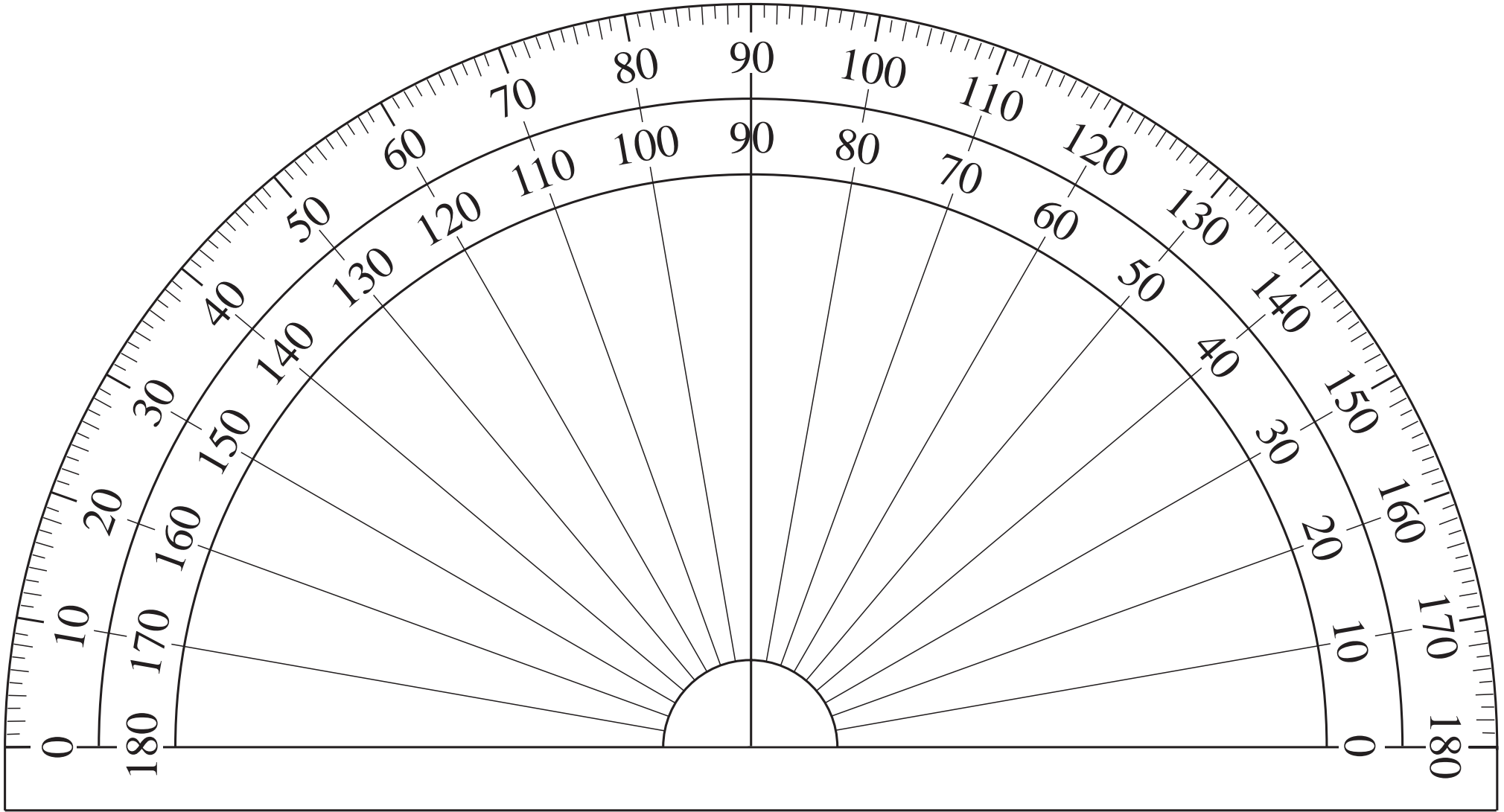

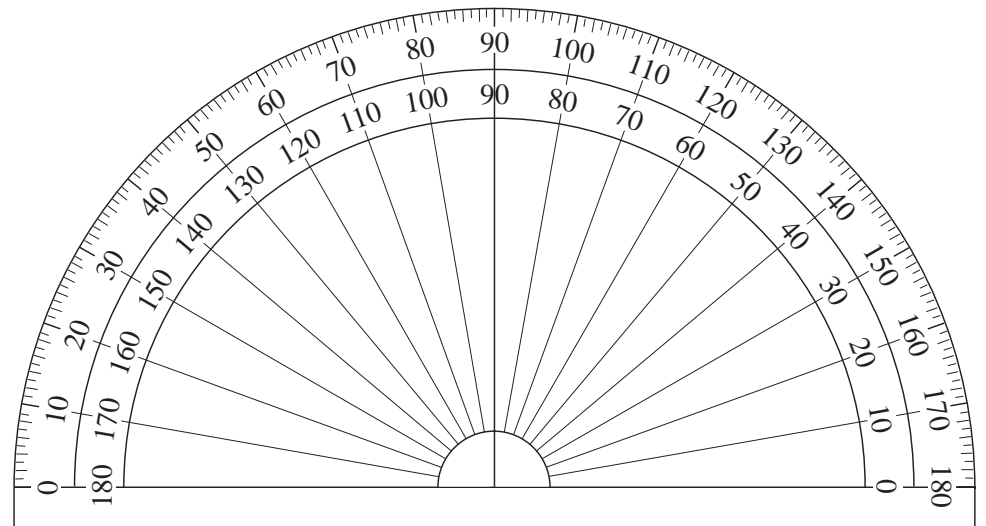
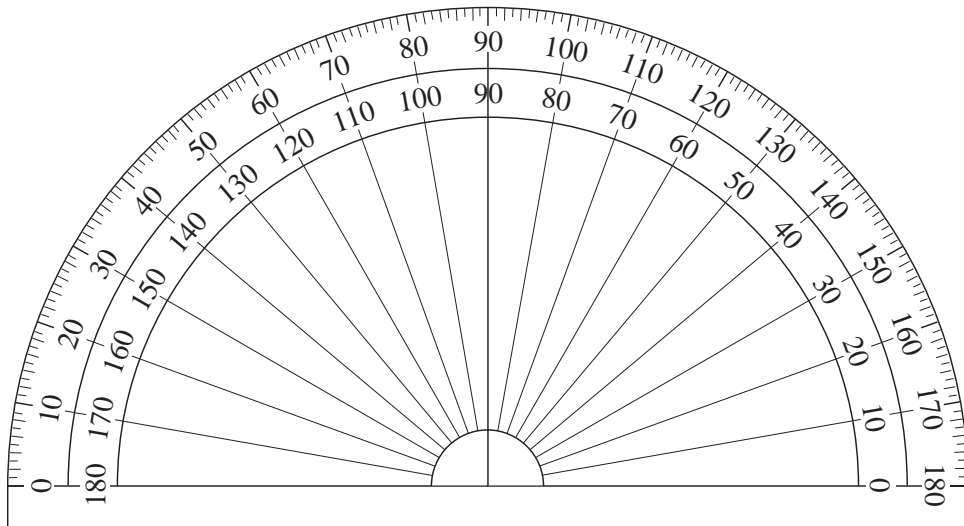
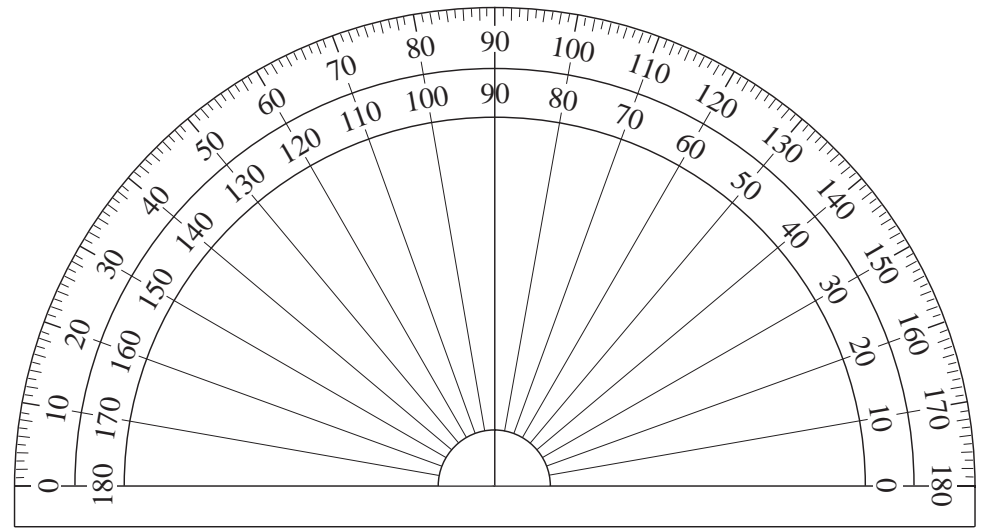
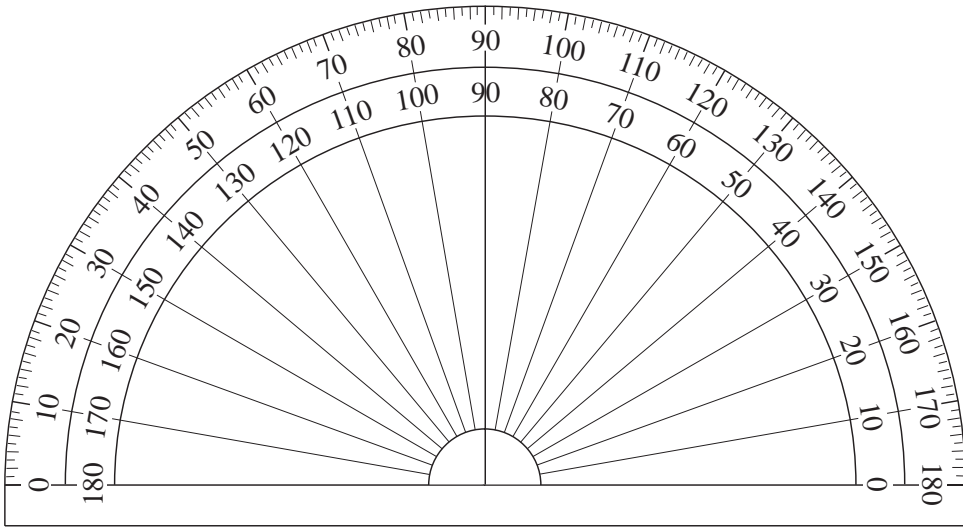

Copy onto OHT and cut out for pupil models.

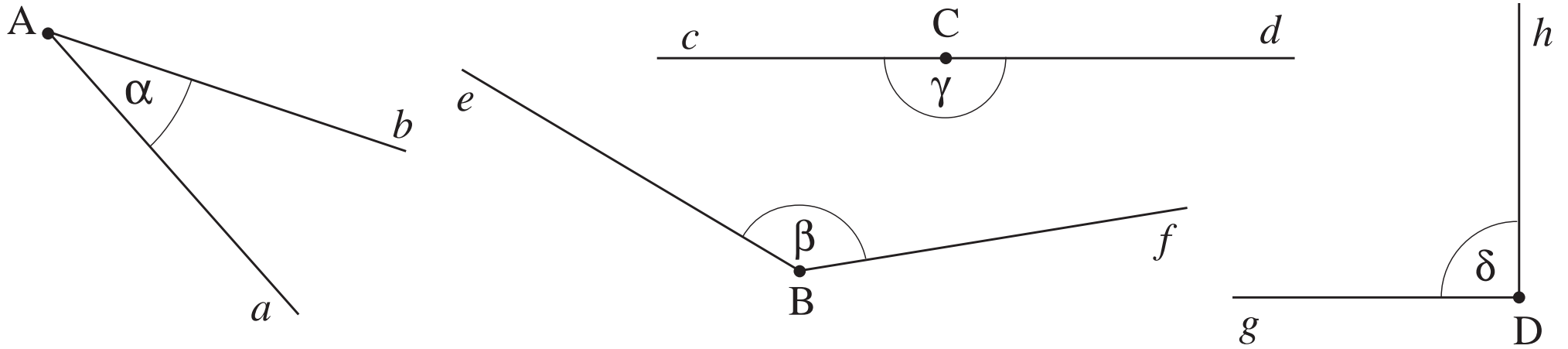

$\alpha \approx \boxed{}$

$\beta \approx \boxed{}$

$\gamma = \boxed{}$

$\delta = \boxed{}$

LP 82/4

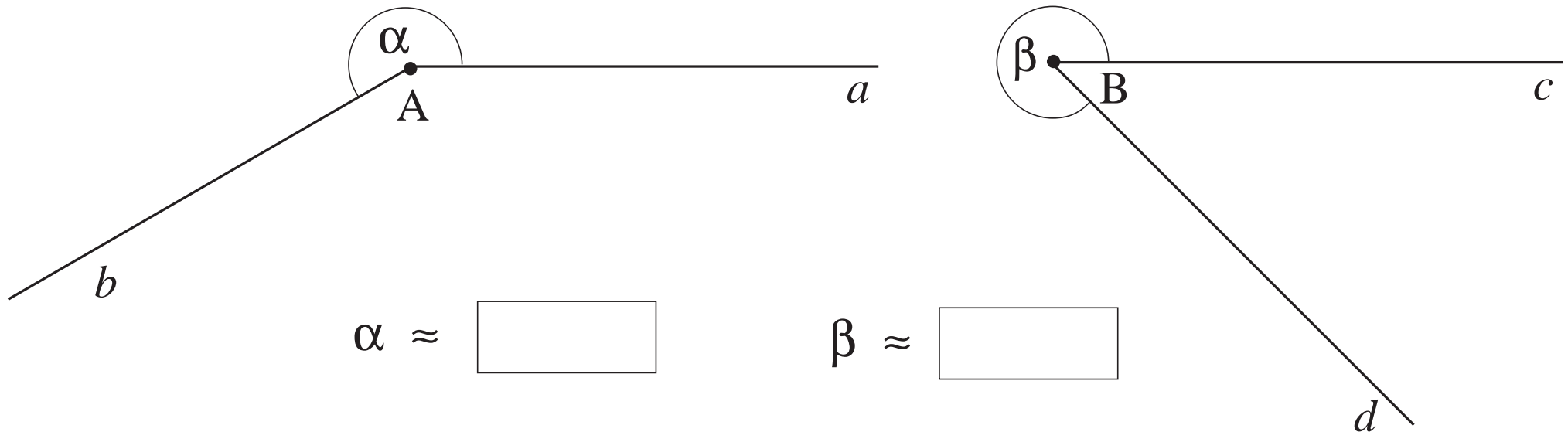

$\alpha \approx \boxed{}$

$\beta \approx \boxed{}$

LP 82/5

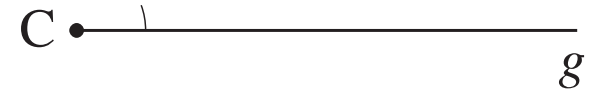
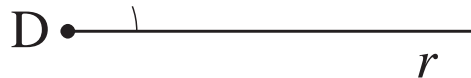
a) 60° b) 20° c) 55° d) 110° e) 240° f) 340° 

$\alpha \approx$

$\beta \approx$

$\gamma \approx$

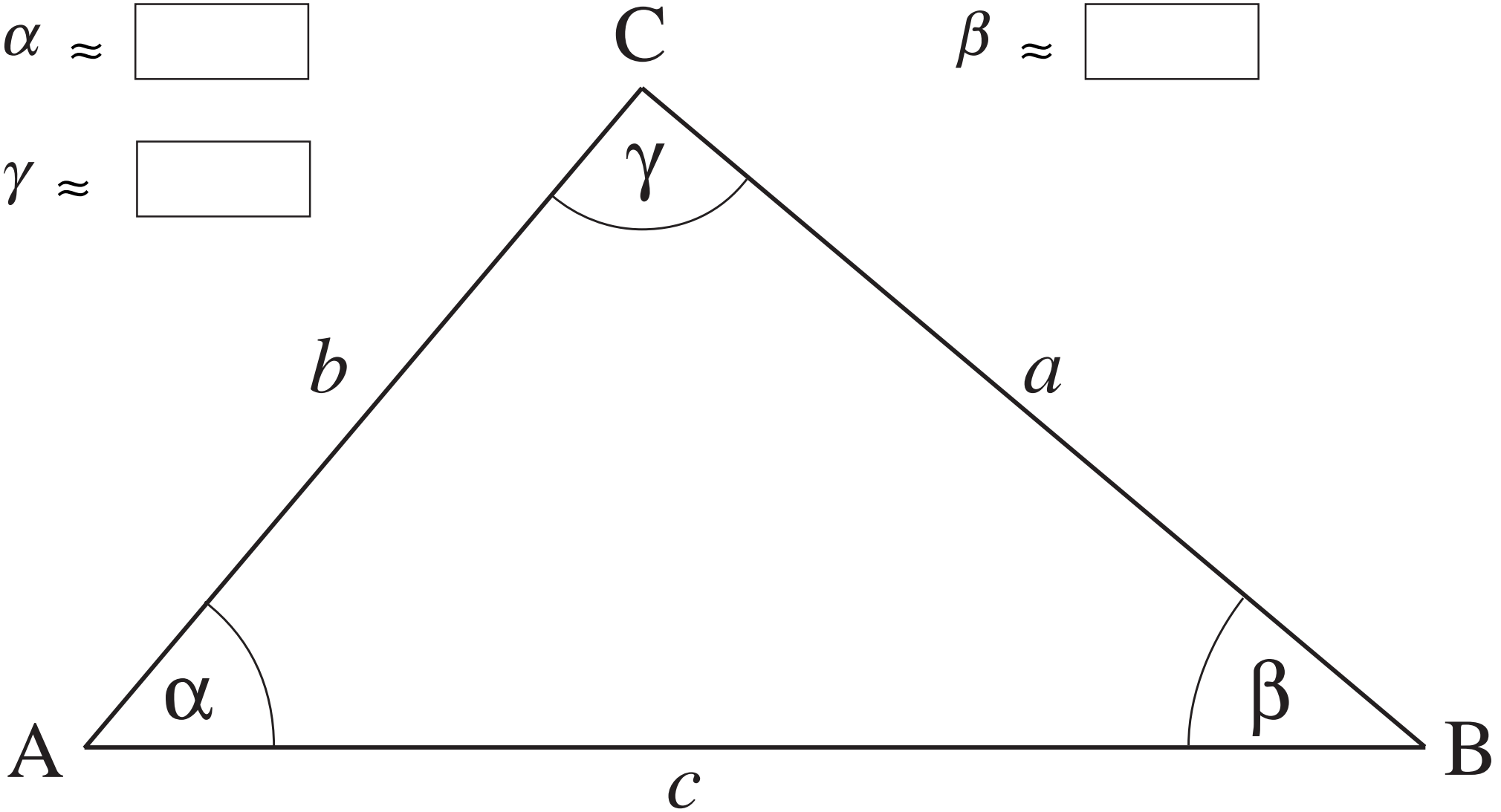

$\alpha + \beta + \gamma \approx$

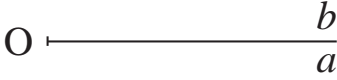
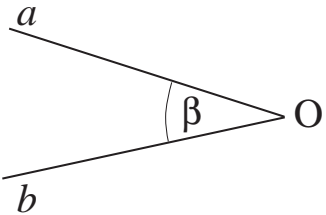
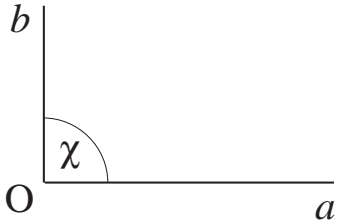
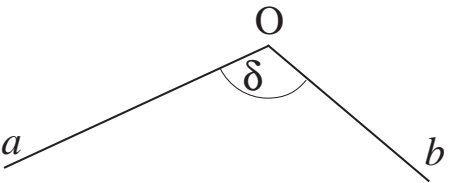
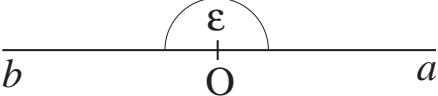
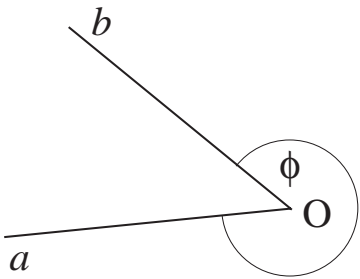
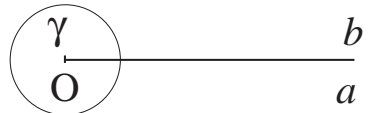
- a)  angle $\alpha =$ $^{\circ}$
- b)  angle $\beta =$ $^{\circ}$
- c)  angle $\chi =$ $^{\circ}$
- d)  angle $\delta =$ $^{\circ}$
- e)  angle $\epsilon =$ $^{\circ}$
- f)  angle $\phi =$ $^{\circ}$
- g)  angle $\gamma =$ $^{\circ}$

72°	acute angle	$181^\circ 40'$
110°	right angle	$2^\circ 11' 3''$
0°	obtuse angle	$33^\circ 33' 33''$
180°	whole angle	$90^\circ 00' 01''$
90°	zero angle	$89^\circ 2'$
300°	straight angle	$172^\circ 40'$
	reflex angle	

$\angle a =$

$\angle b =$

$\angle c =$

$\angle d =$

$\angle e =$

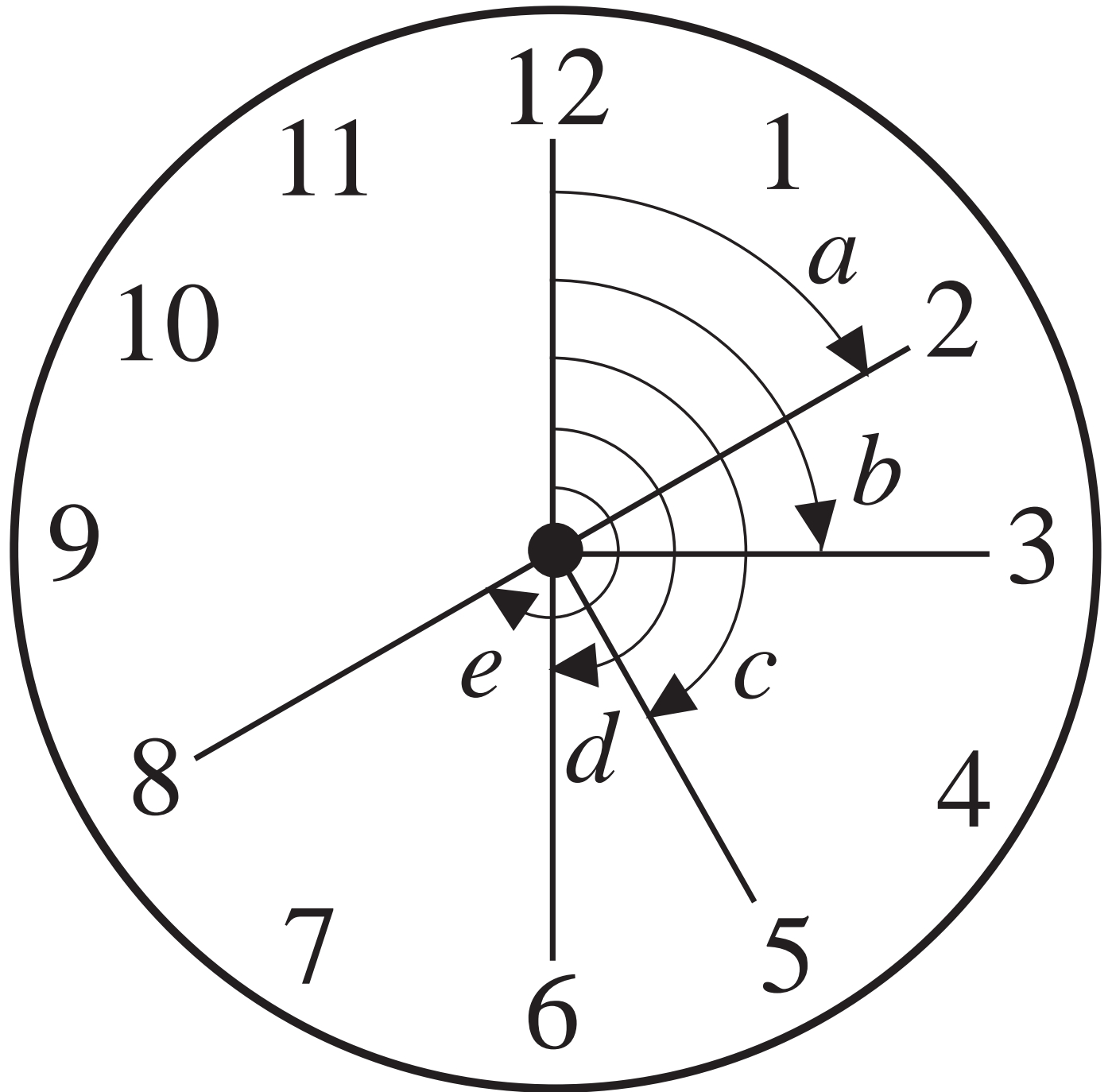

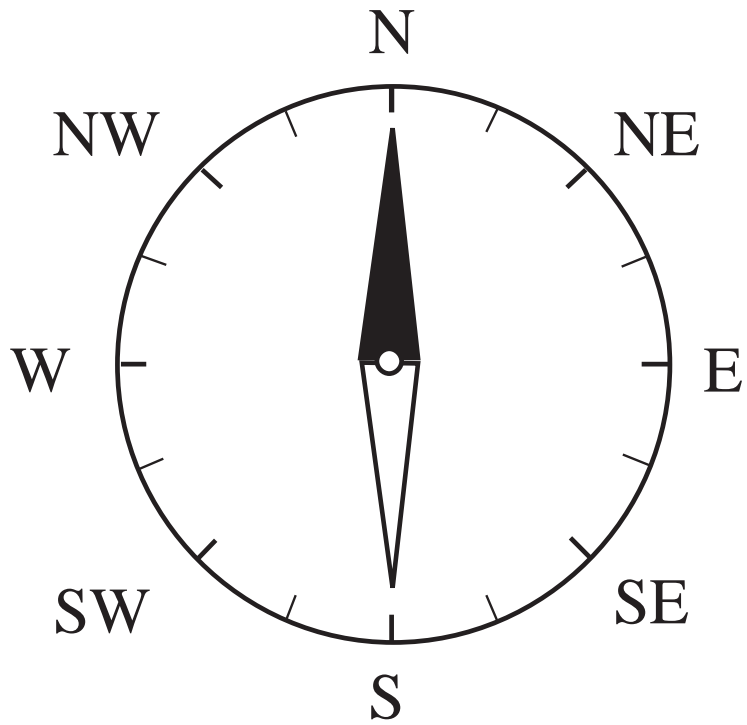

a) N and NE

b) N and E

c) N and SE

d) N and SW

e) NE and SE

f) E and NW

g) W and SSW

h) E and NNE

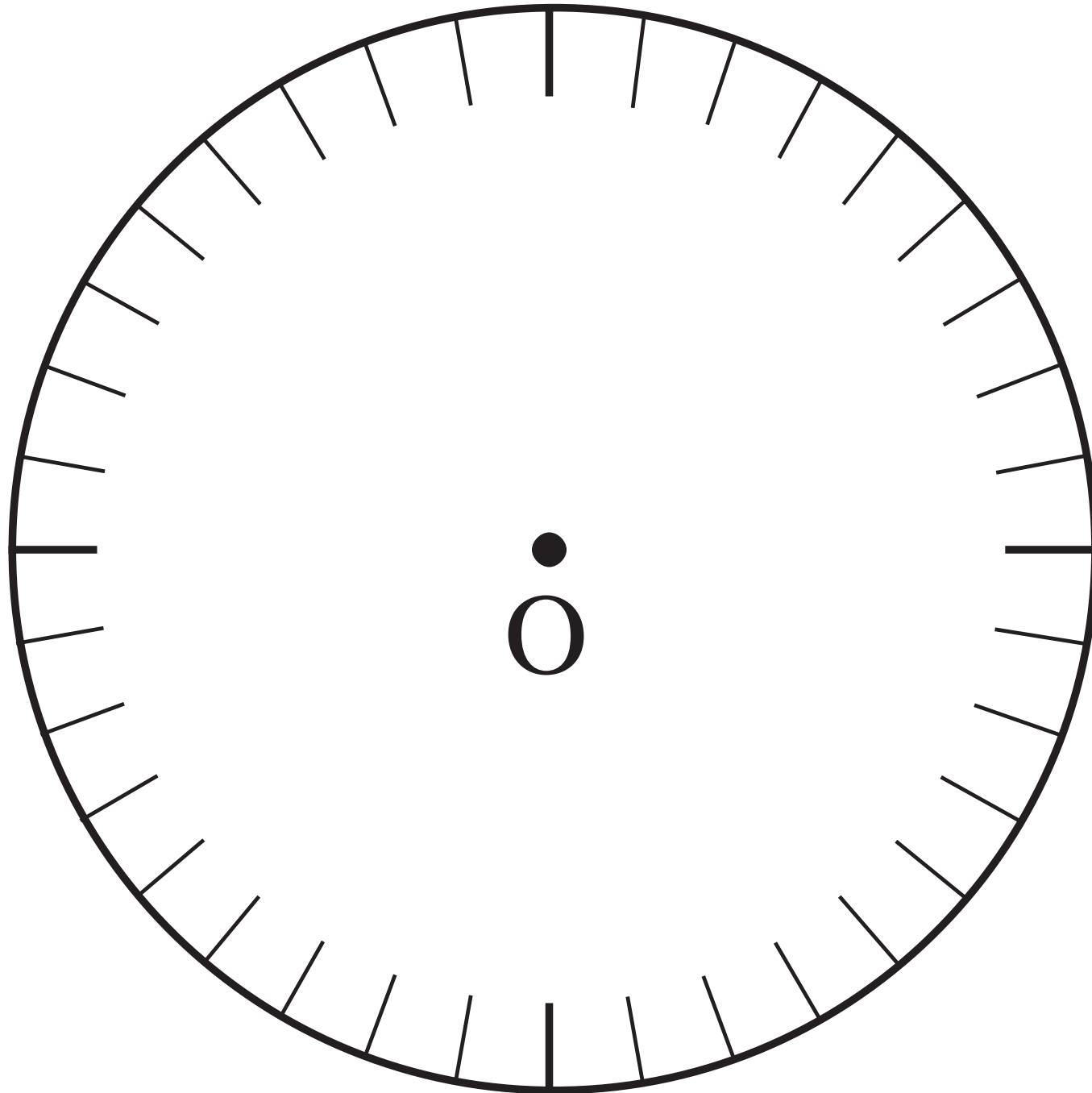

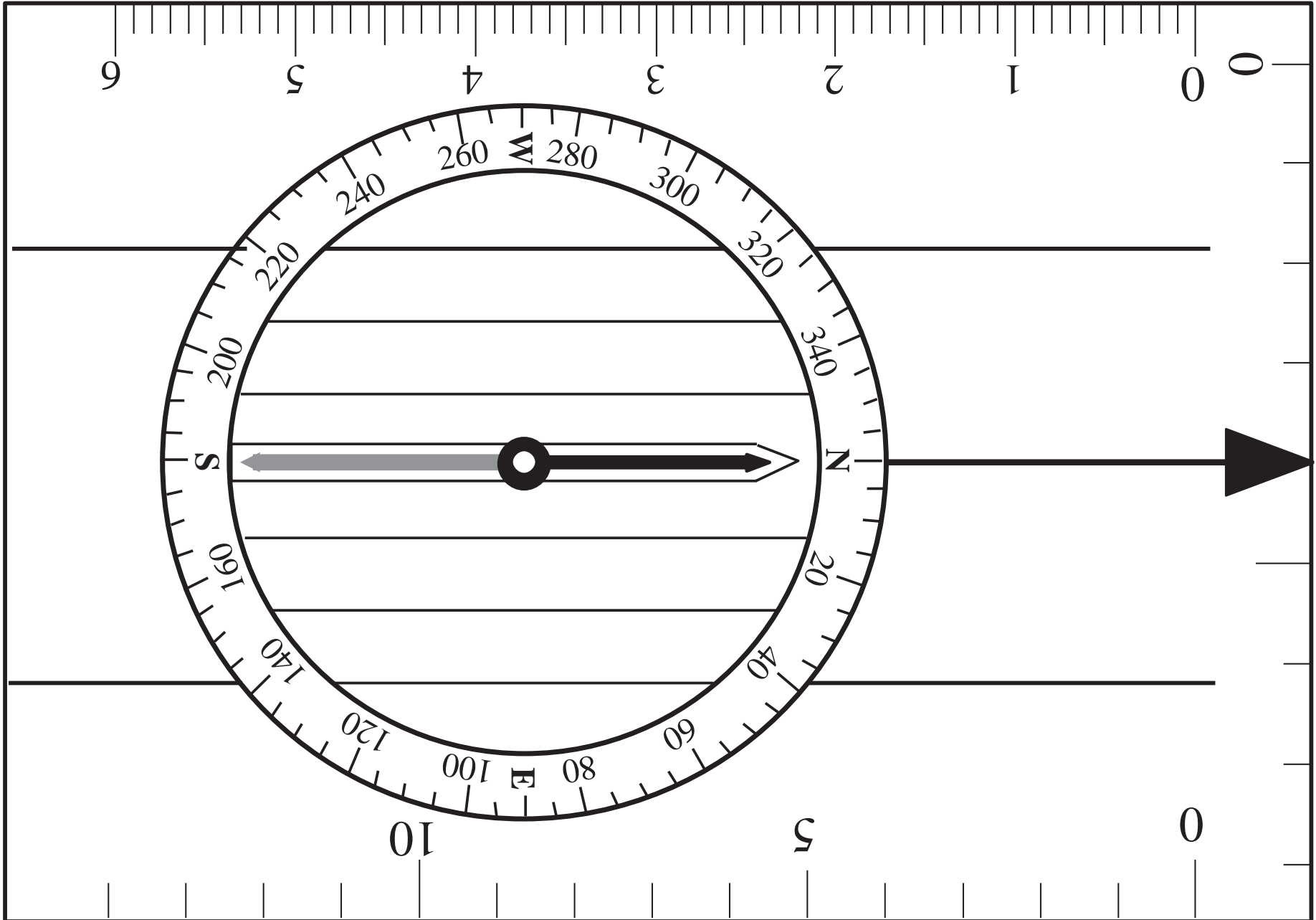

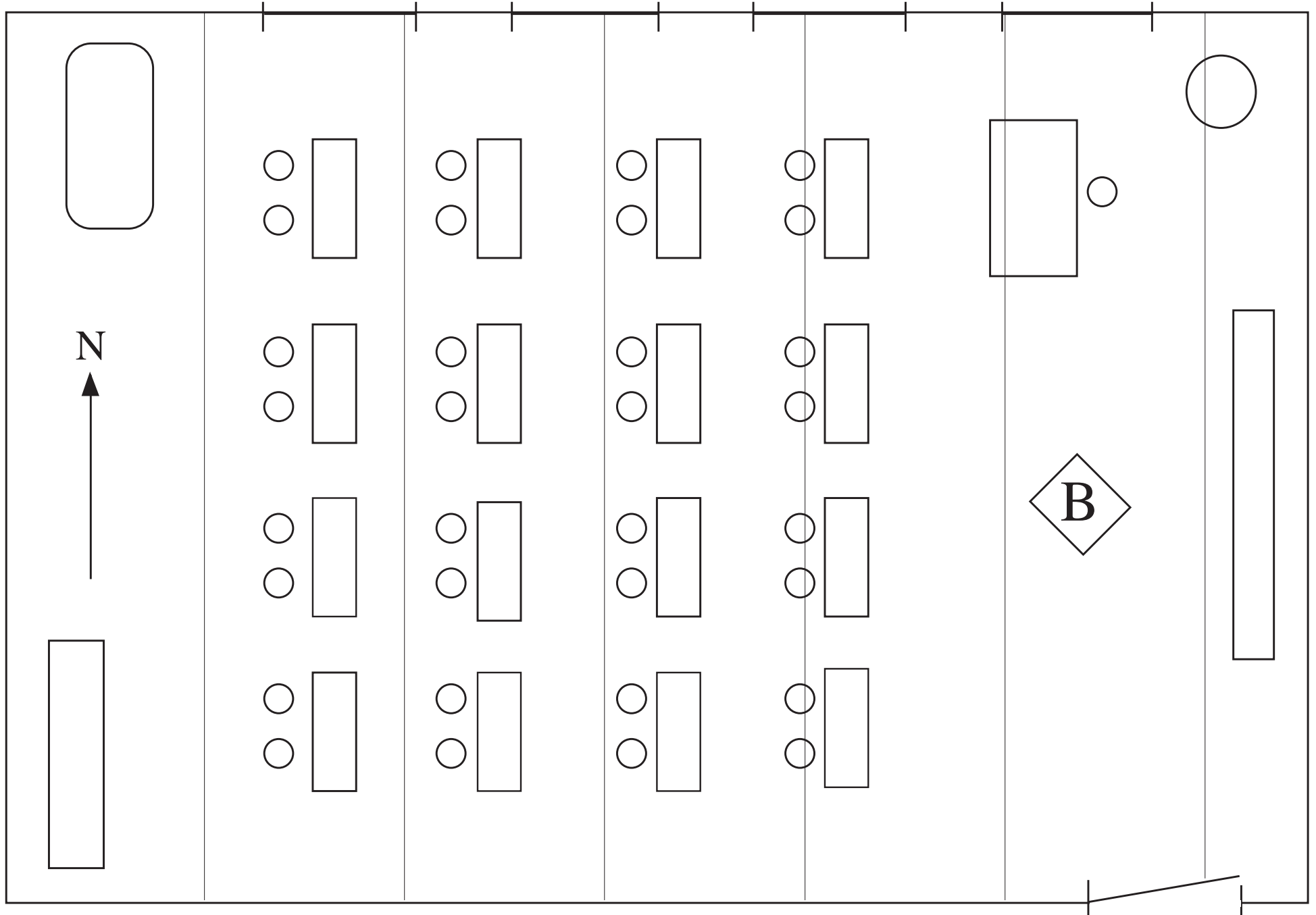

Sketch

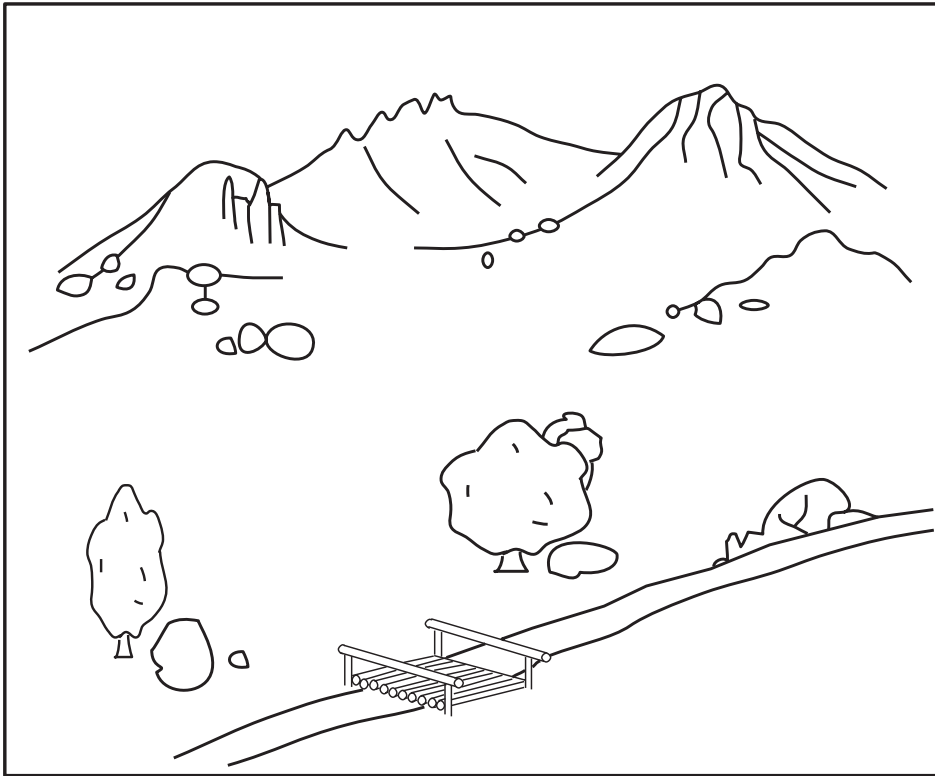

Map

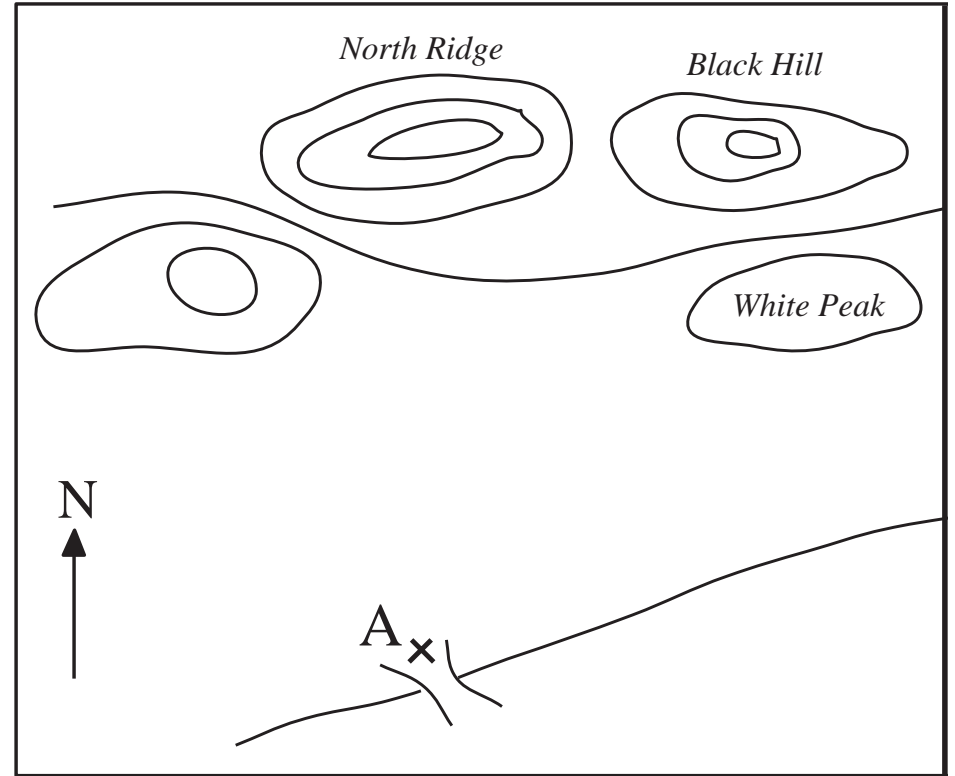

a)

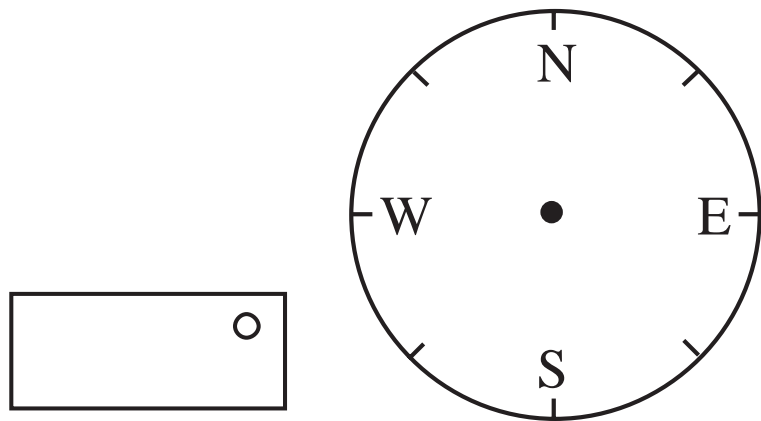

b)

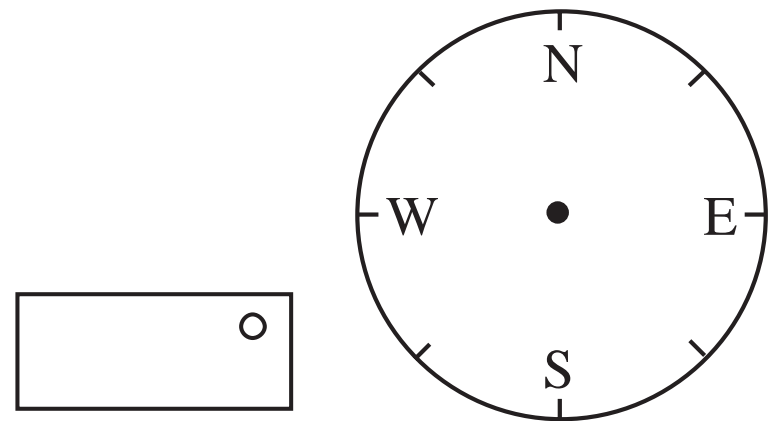

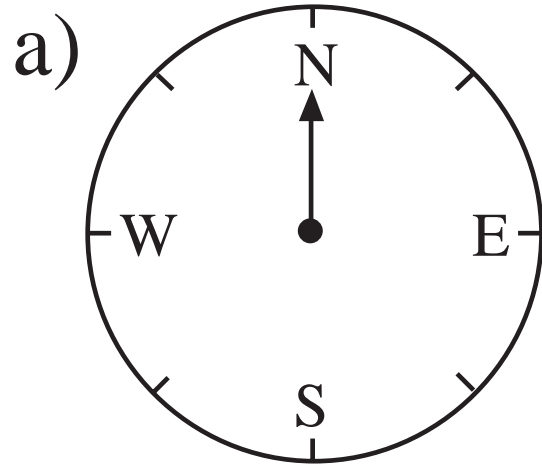

$+ 90^\circ$

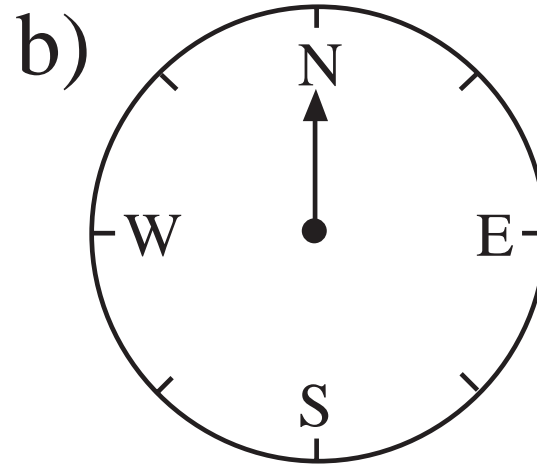

$- 135^\circ$

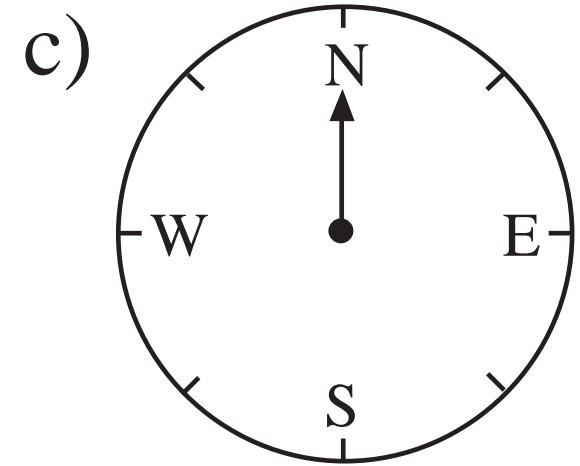

$- 45^\circ$

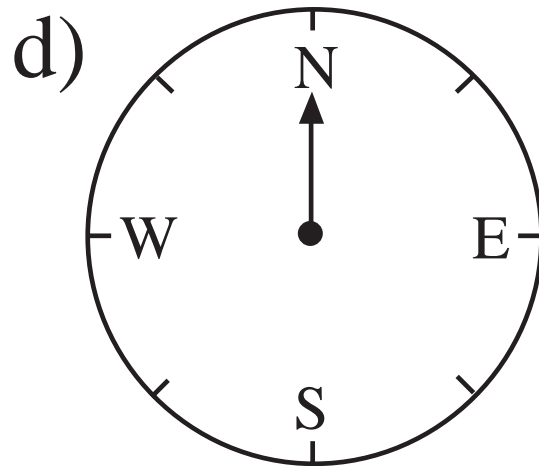

$+ 225^\circ$

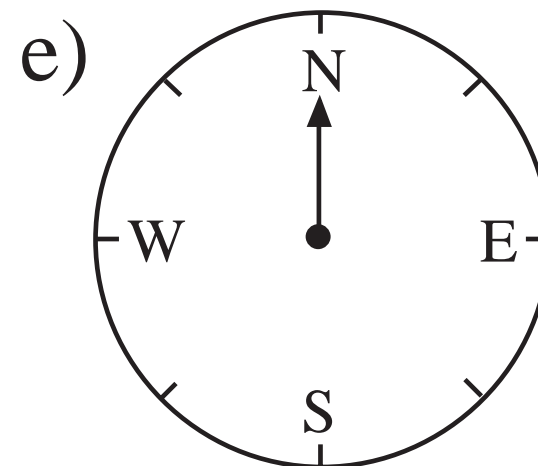

$- 270^\circ$

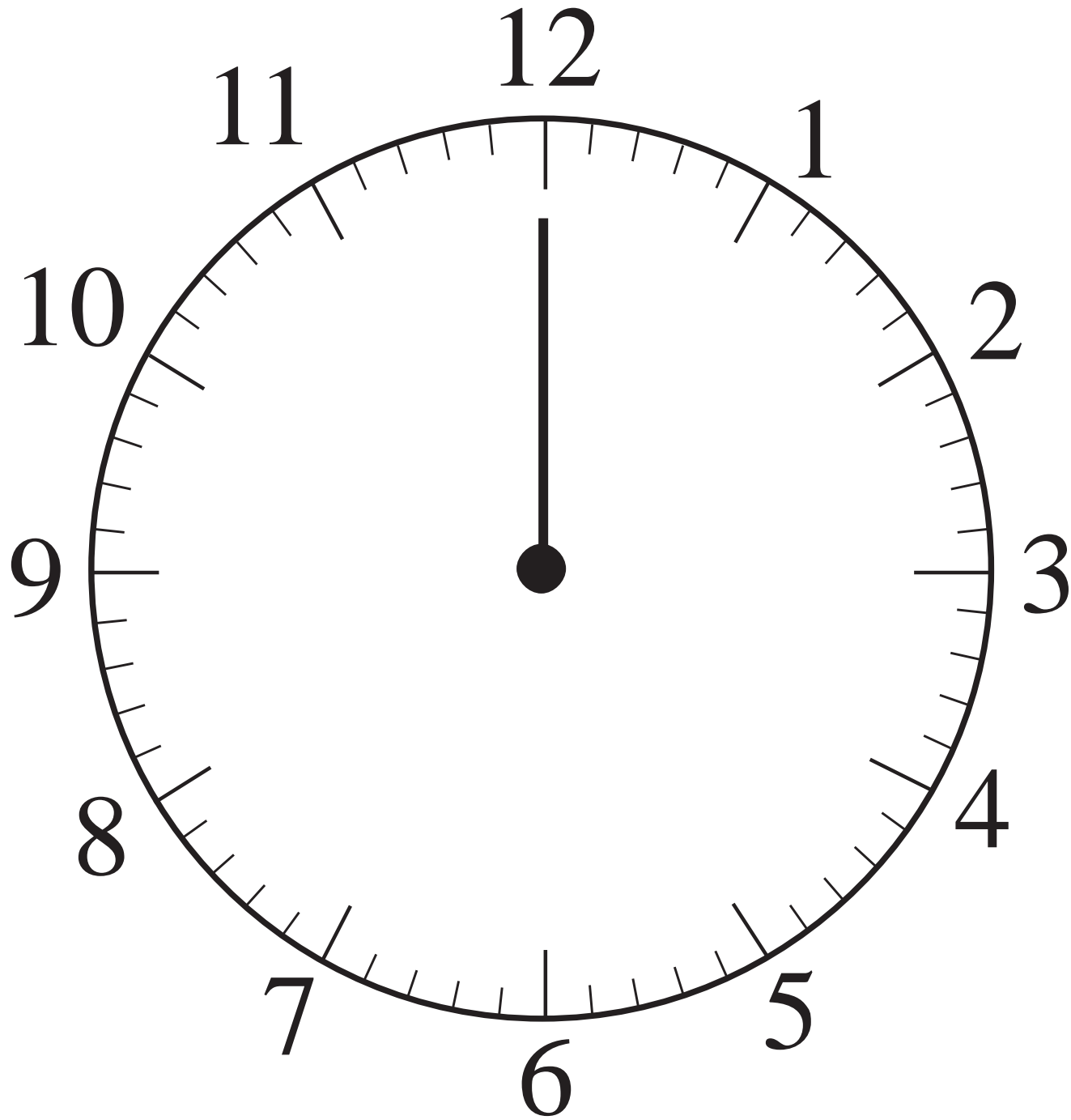

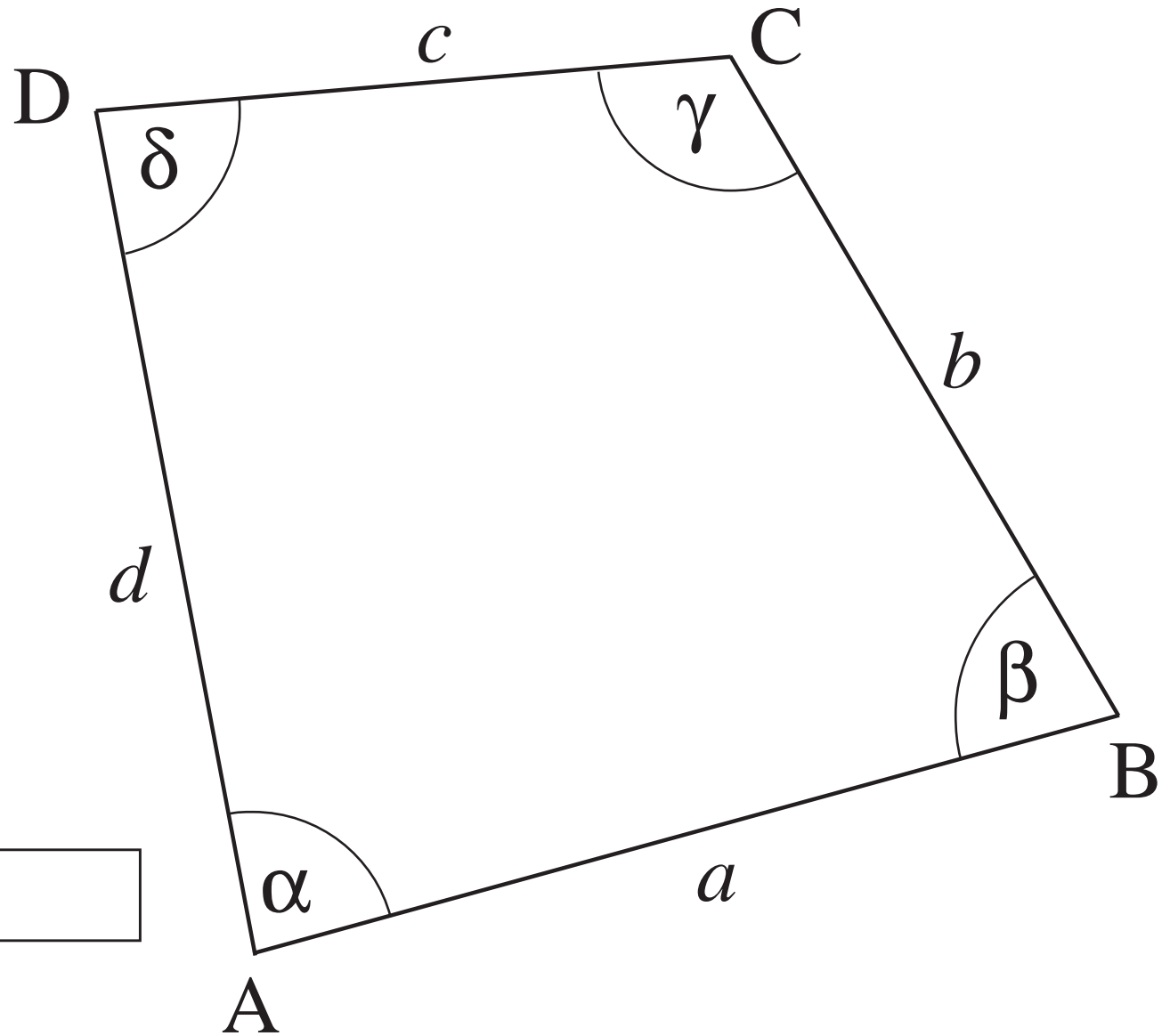

$$\alpha \approx \boxed{}$$

$$\beta \approx \boxed{}$$

$$\gamma \approx \boxed{}$$

$$\delta \approx \boxed{}$$

$$\alpha + \beta + \gamma + \delta \approx \boxed{}$$

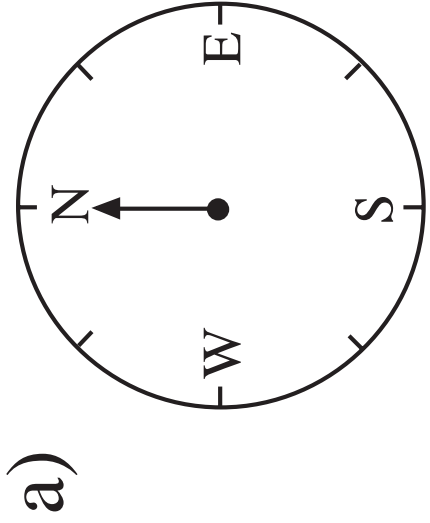

1 and a half
right angles
clockwise

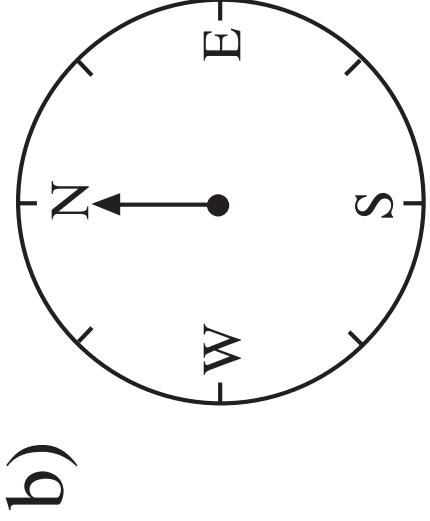

half a right angle
anti-clockwise

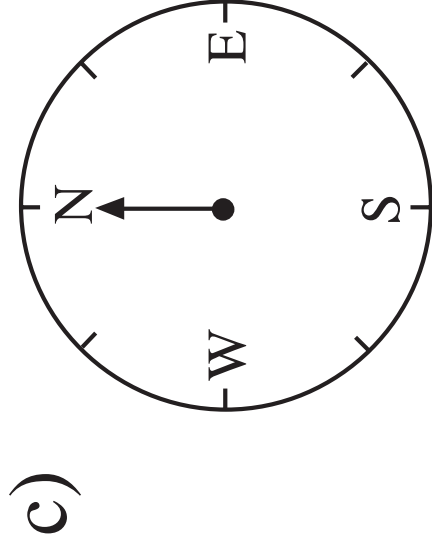

2 and a half
right angles
clockwise

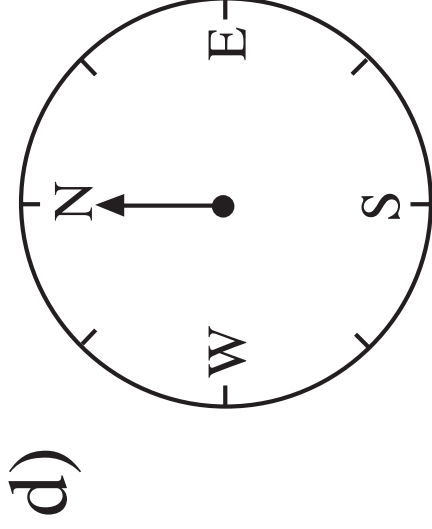

1 and a quarter
right angles
clockwise

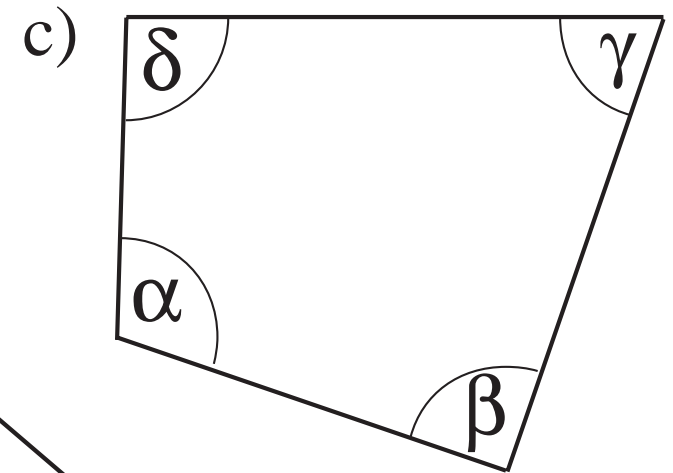
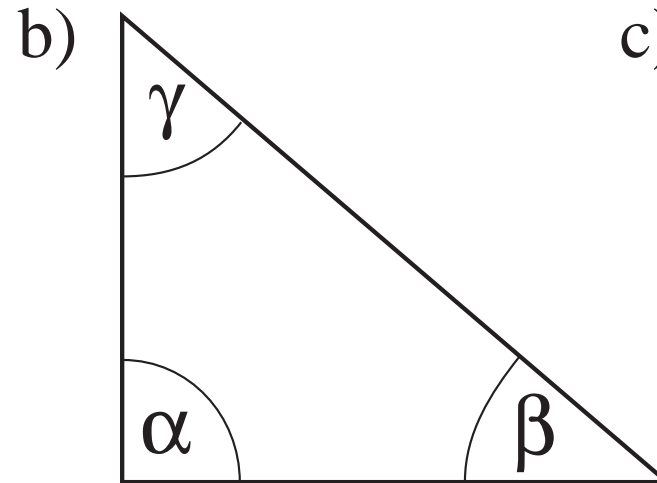
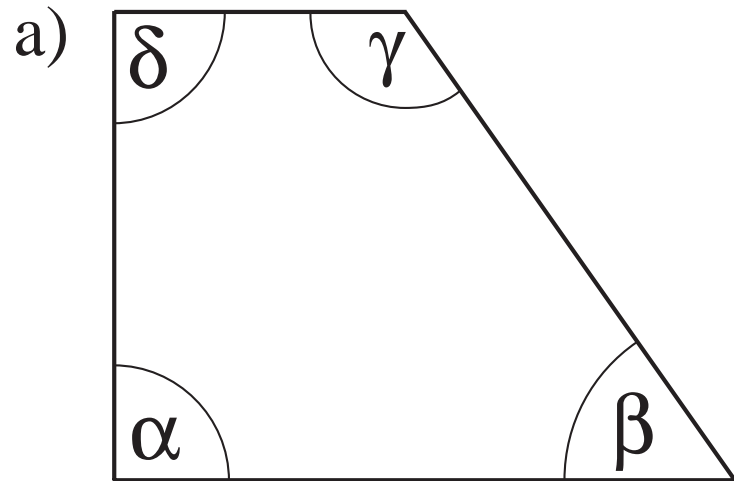
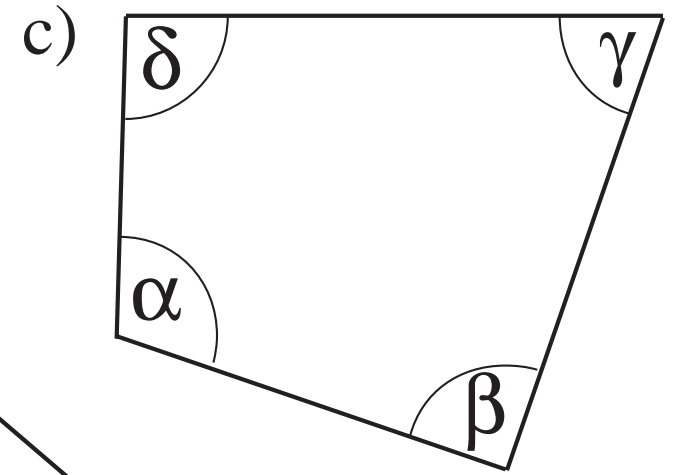
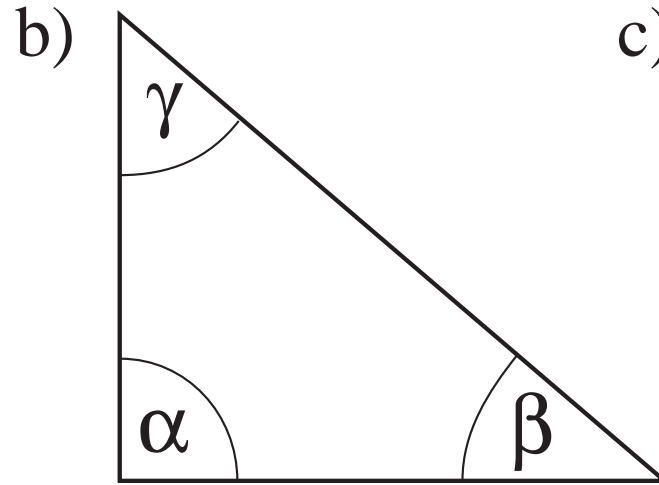
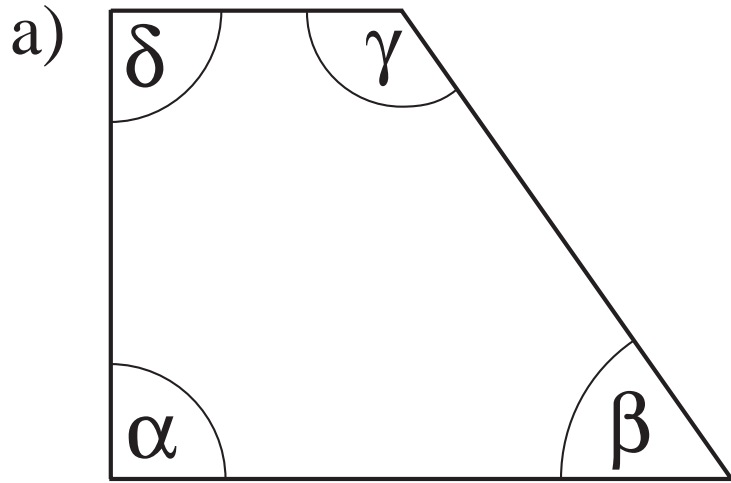

a)

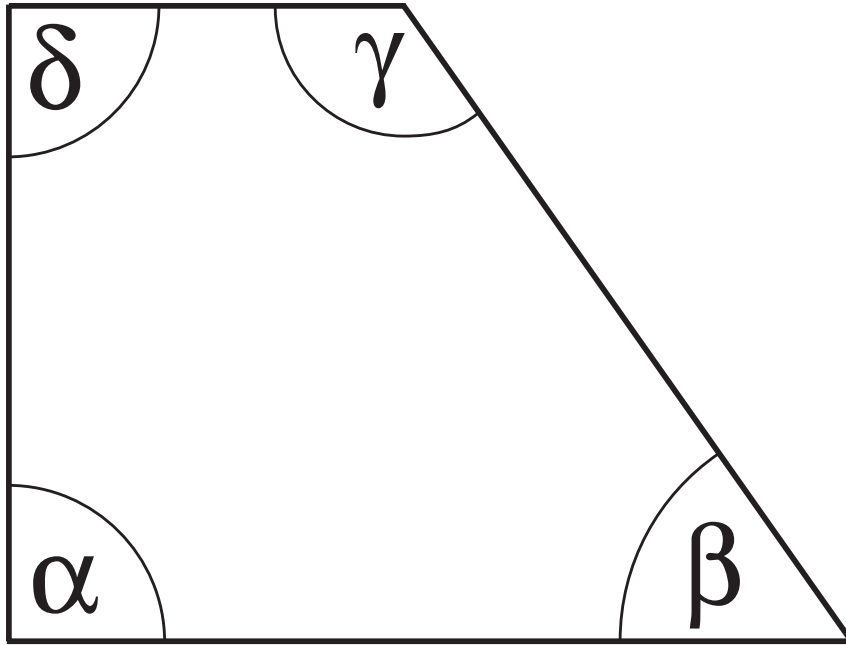

b)

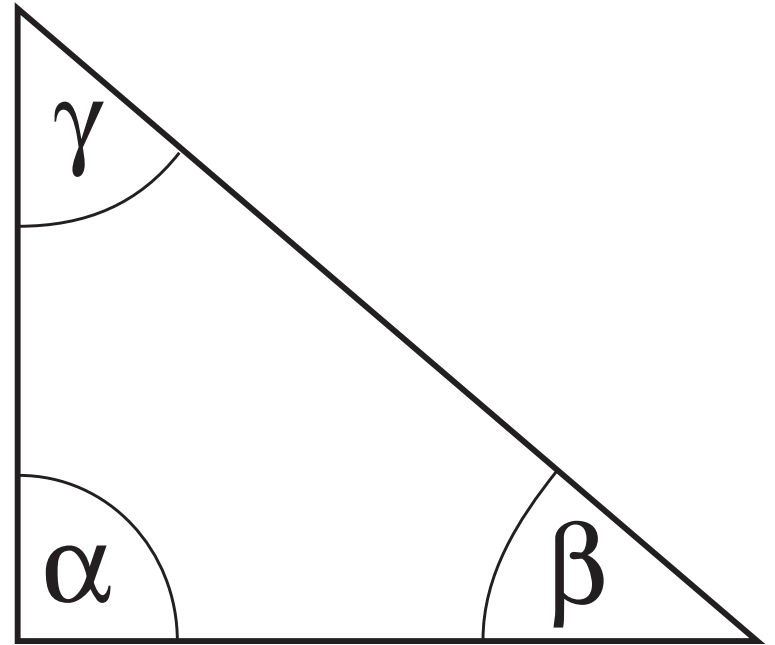

c)

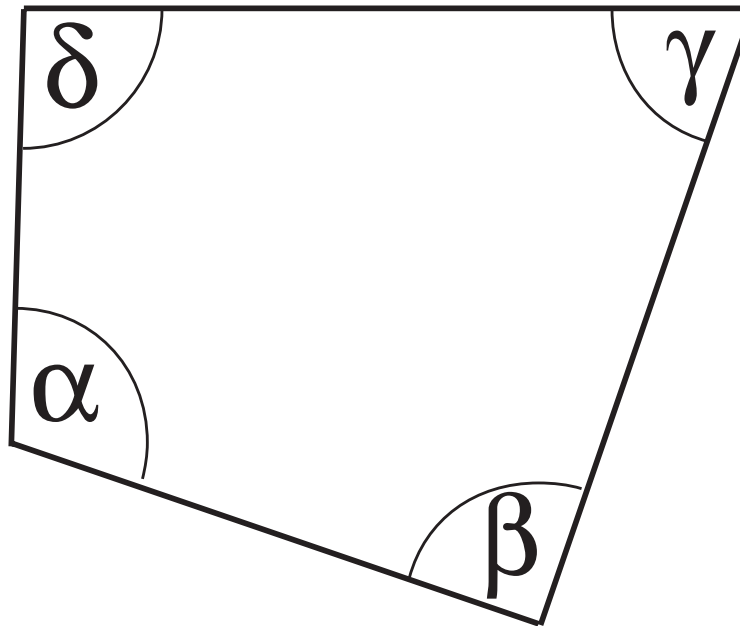

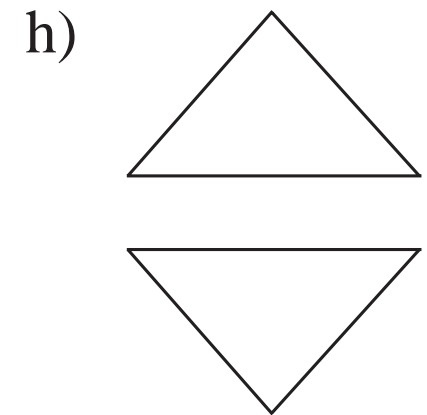
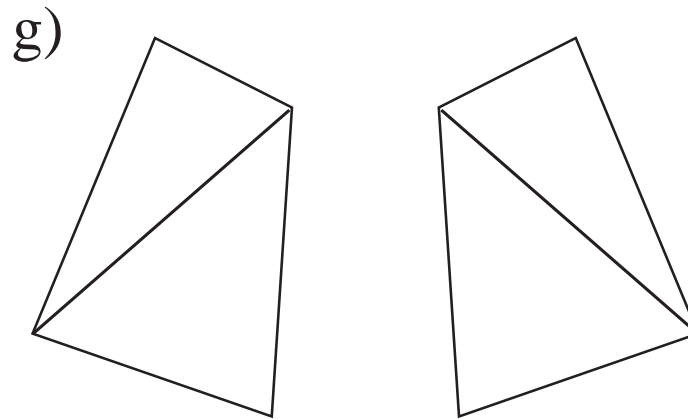
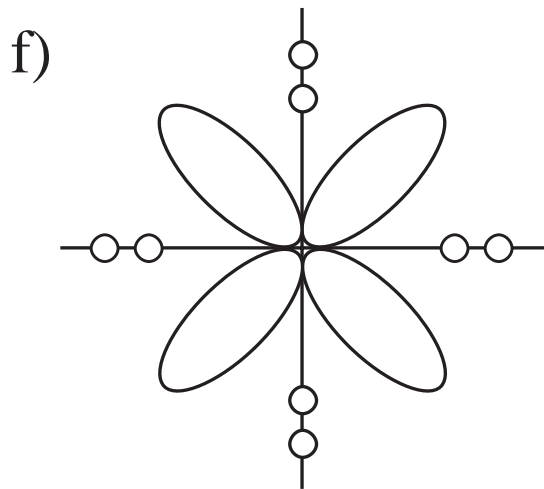
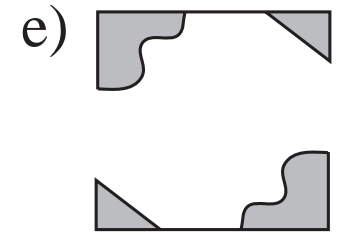
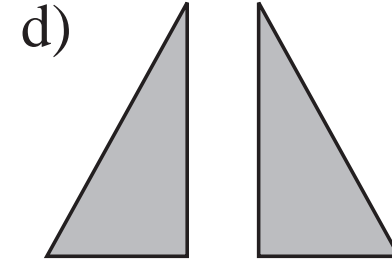
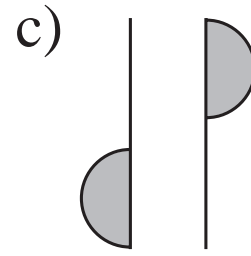
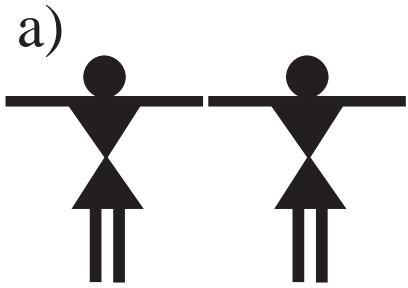

a)

mirror line

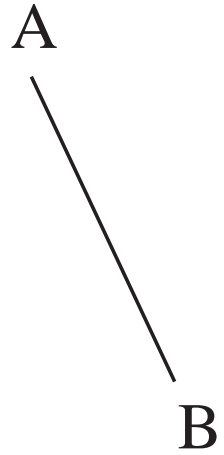

b)

mirror line

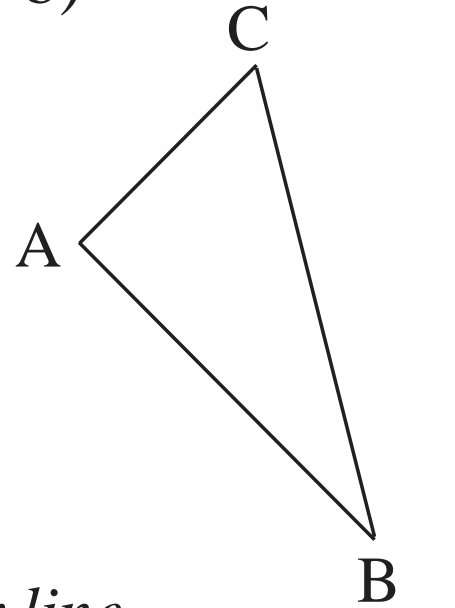

c)

mirror line

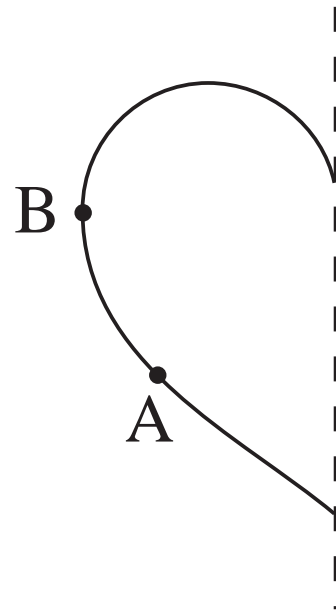

a)

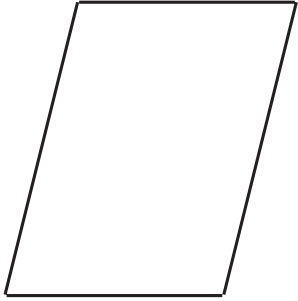

b)

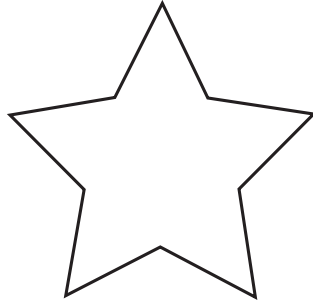

c)

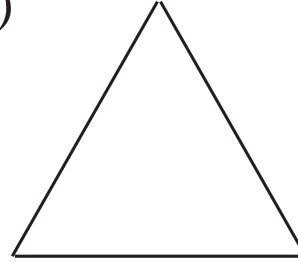

d)



e)

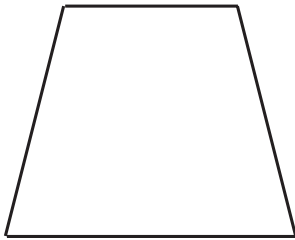

f)

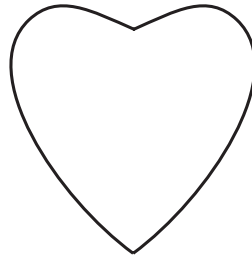

g)

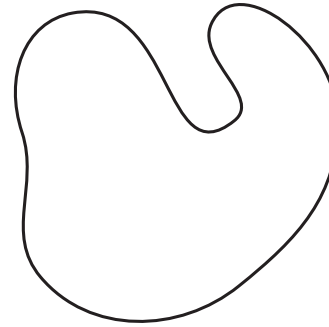

h)

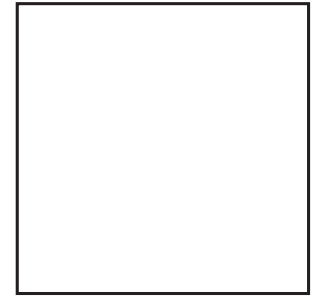

a)

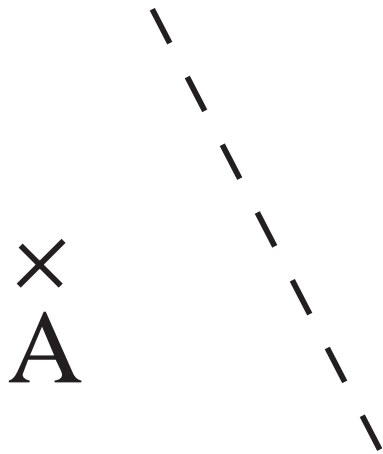

b)

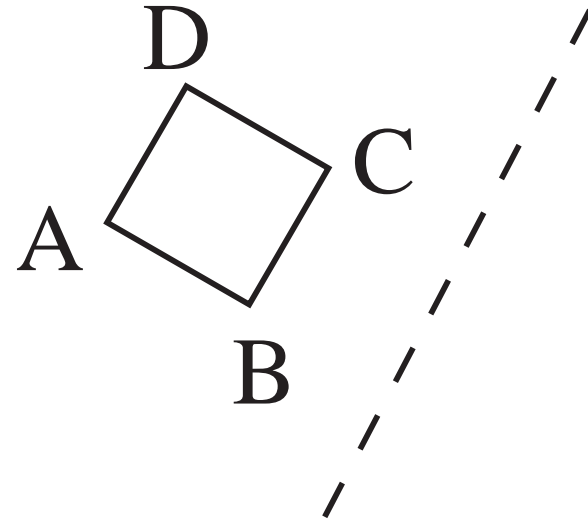

c)

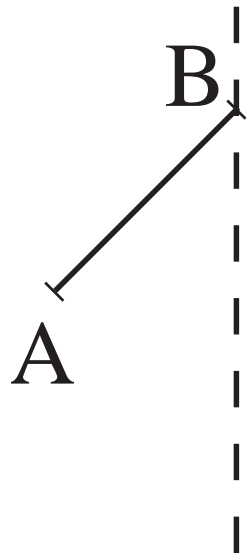



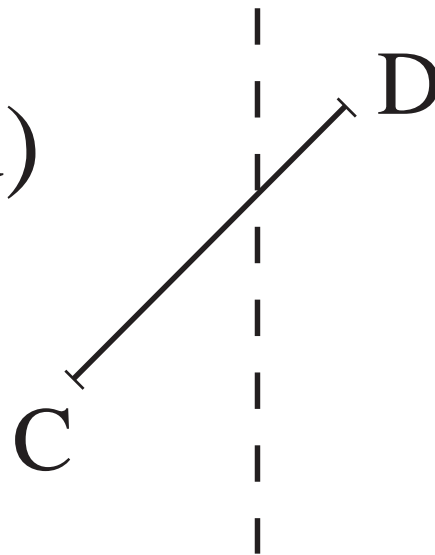

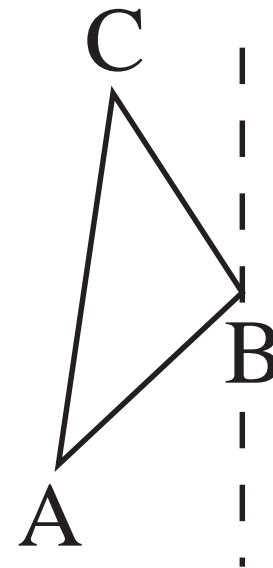

d)



e)



In	A	T			E	7				
Out										

LP 87/1

a)

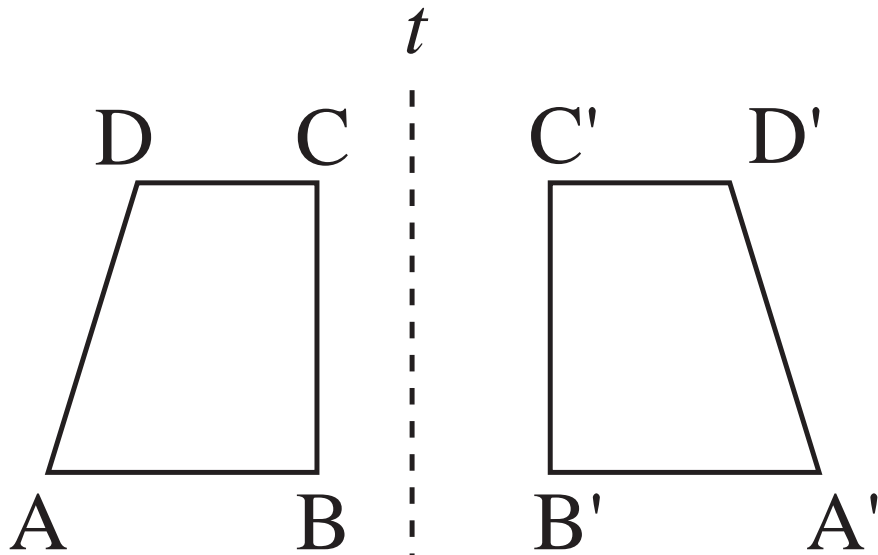

b)

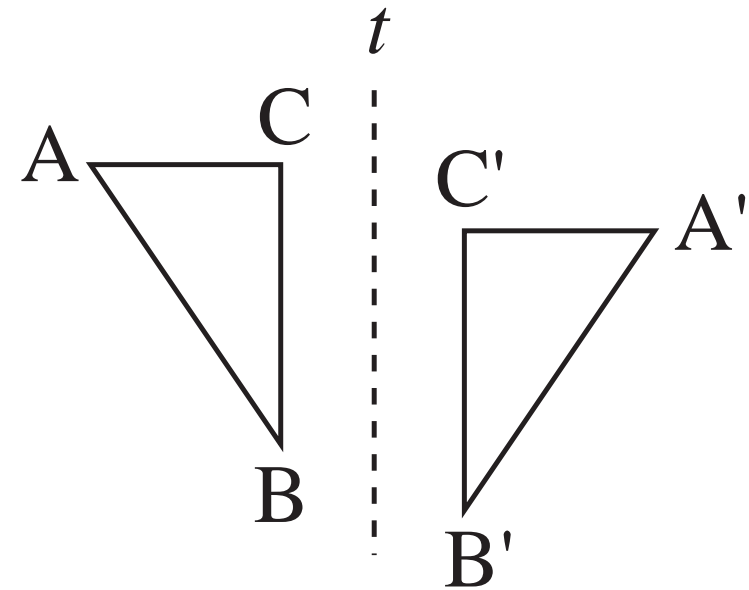

LP 87/3

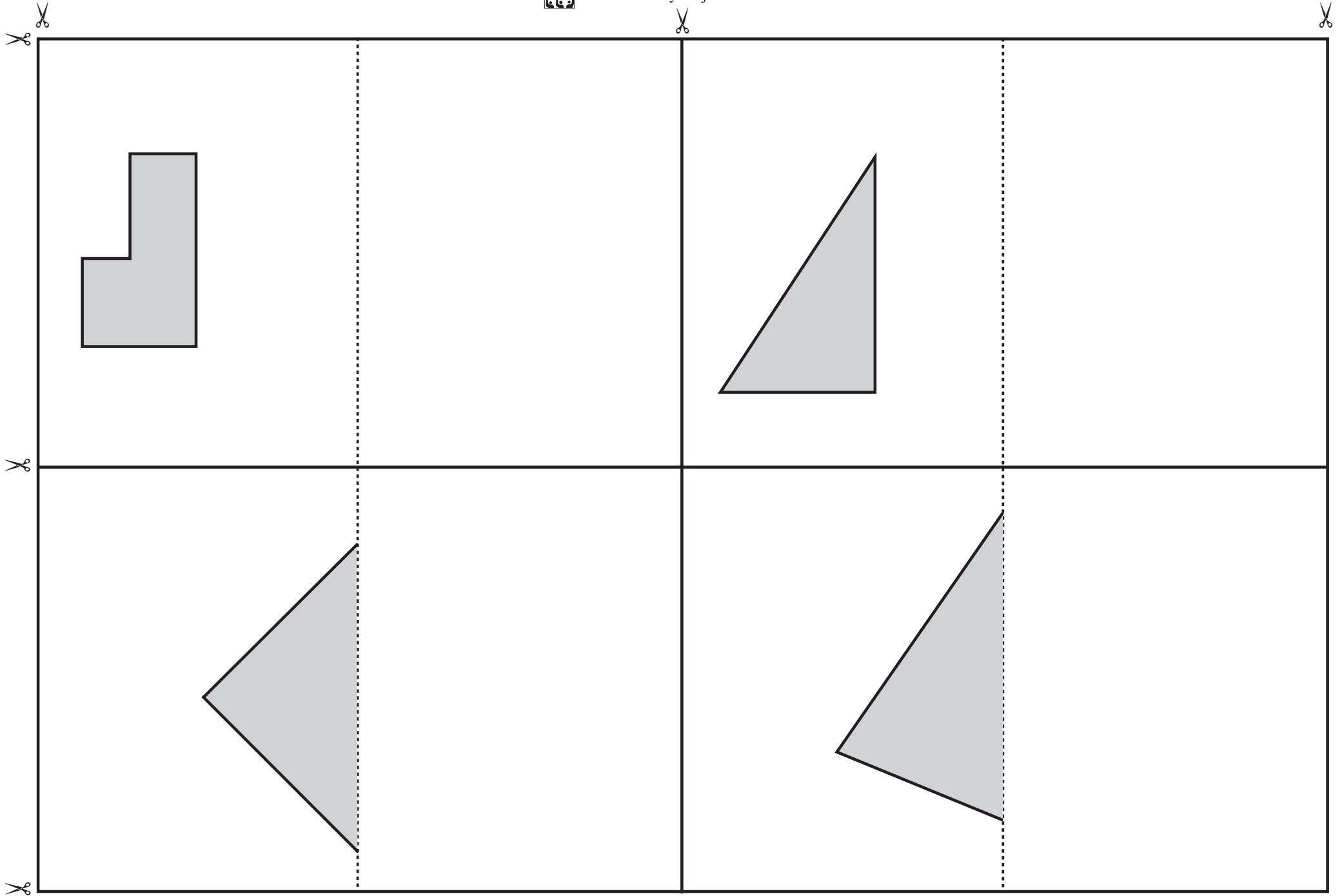

1 sheet per P, cut into 4: a), b), d), e)

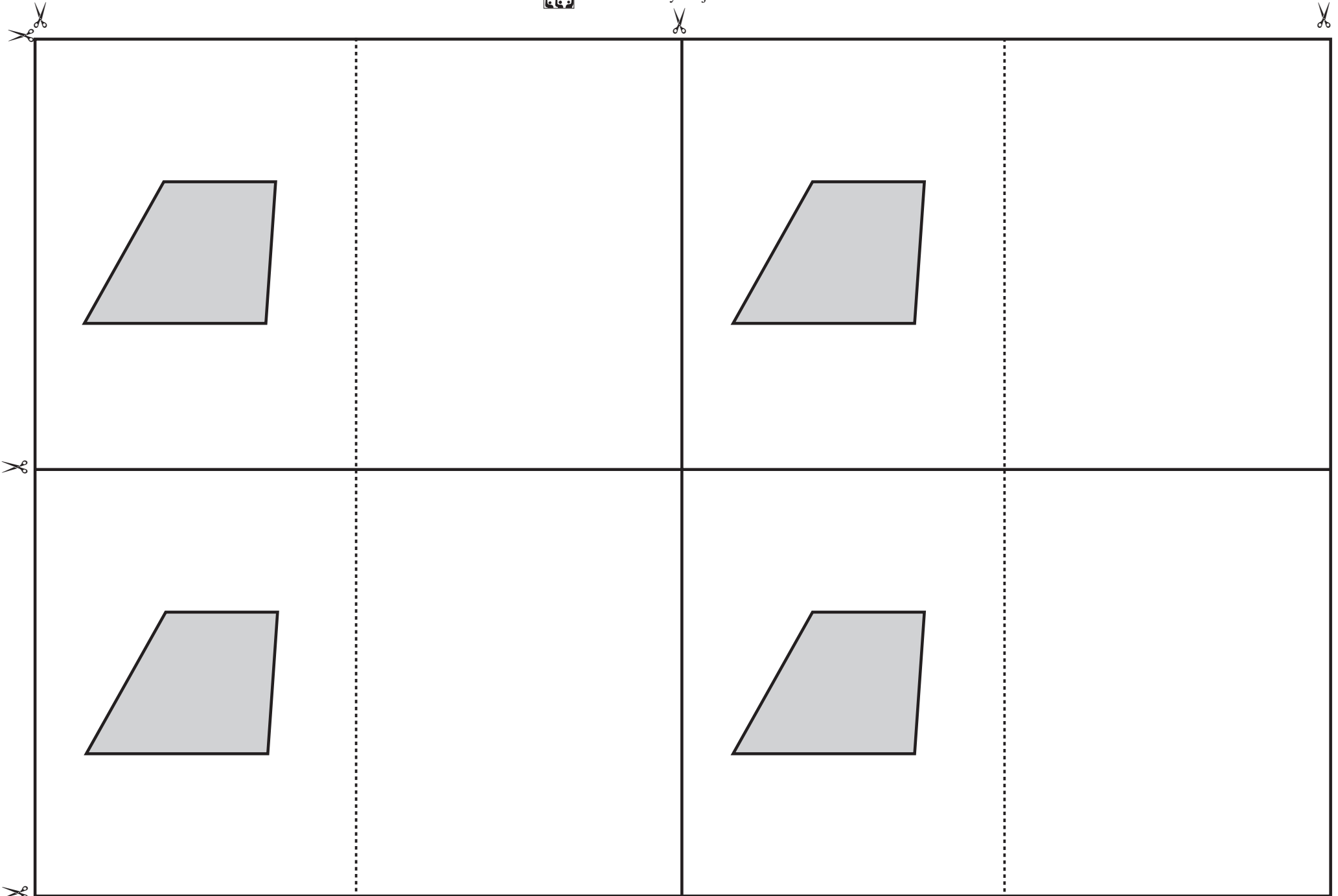

1 sheet per 5 Ps, cut into 4: c)

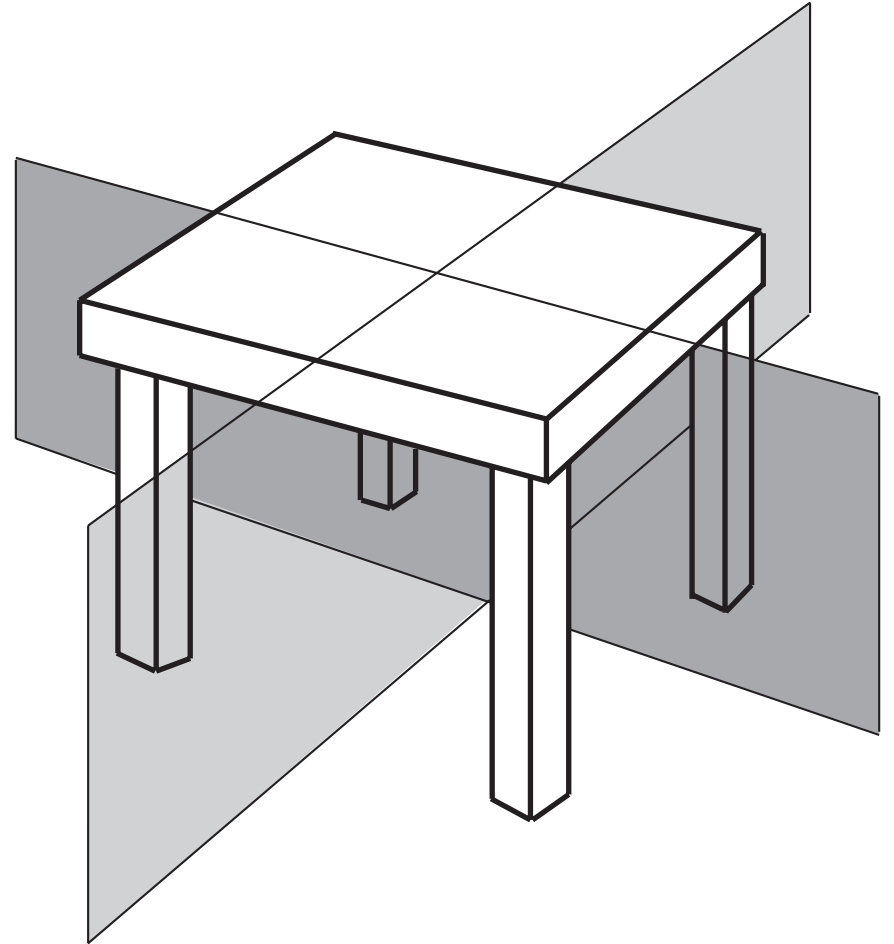
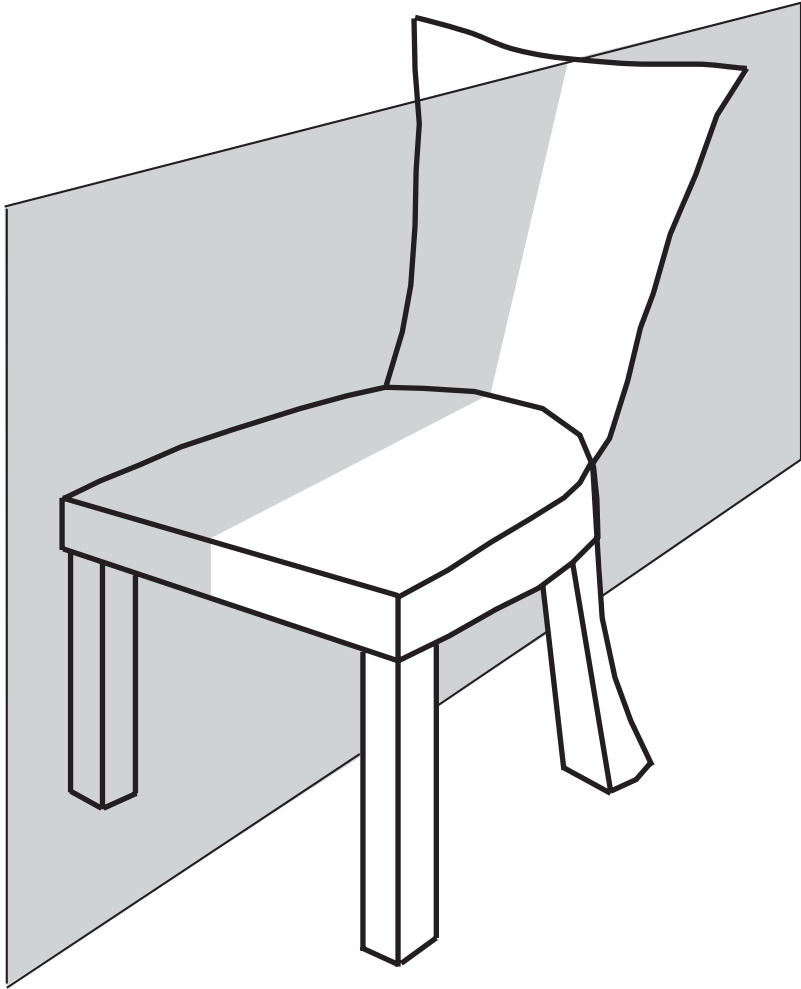

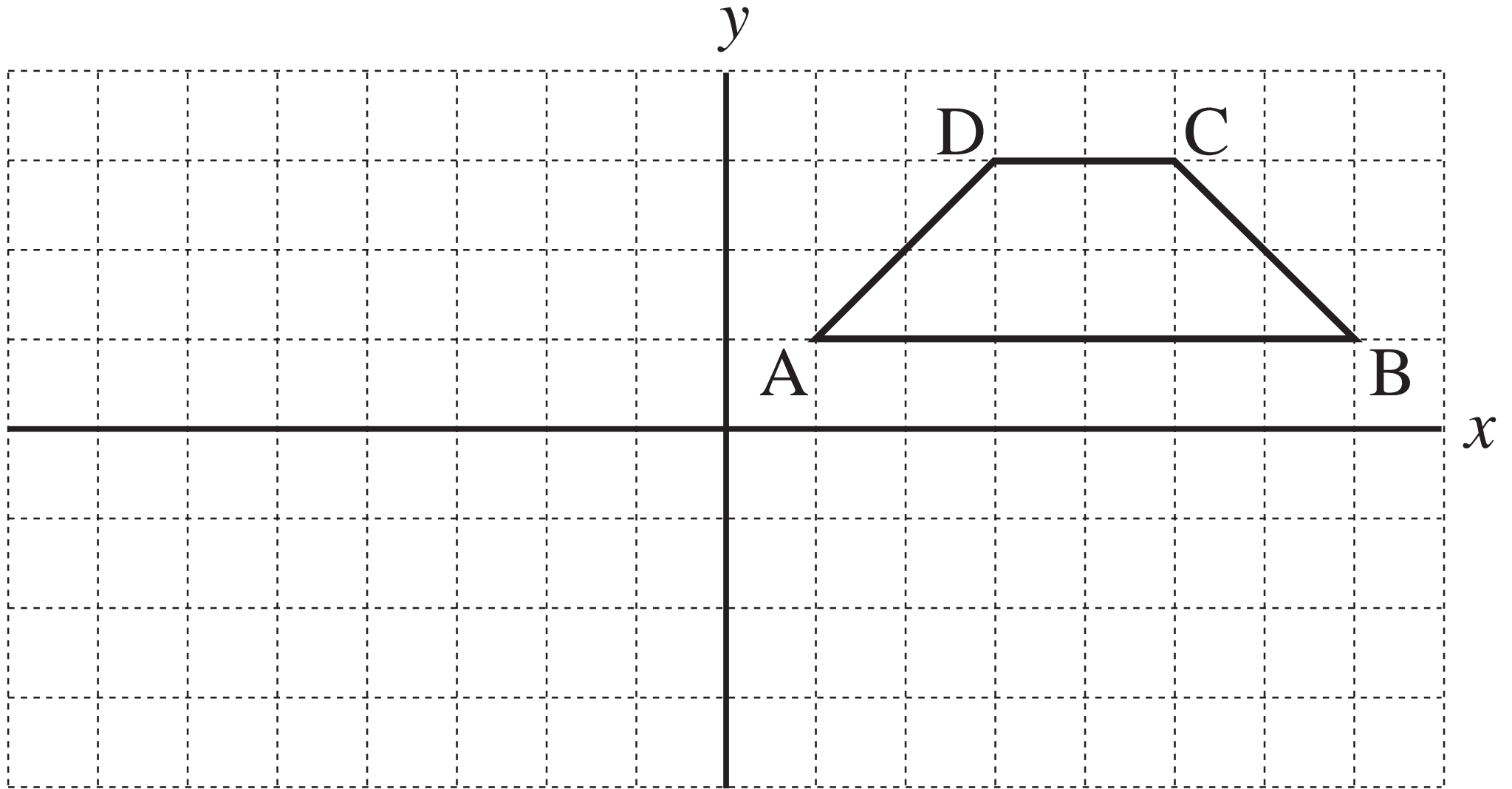

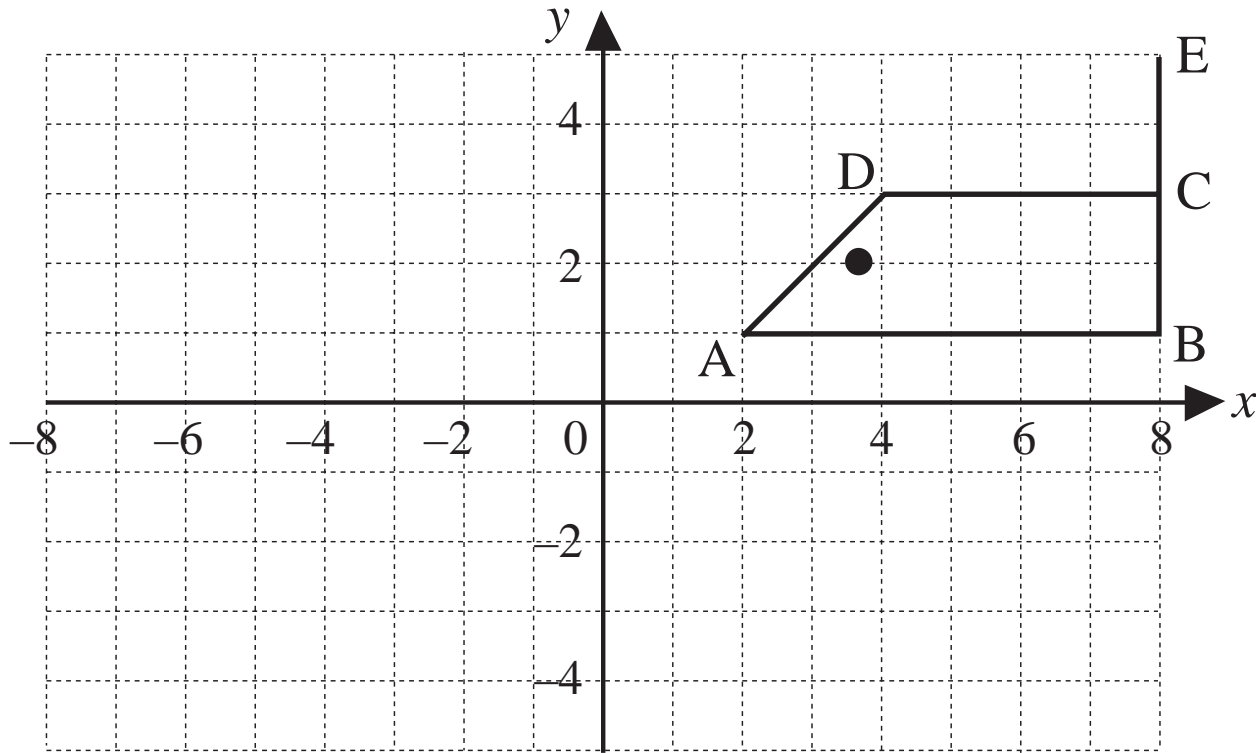

A (2, 1) B (,) C (,)

D (,) E (,)

A' (,) B' (,) C' (,)

D' (,) E' (,)

A* (,) B* (,) C* (,)

D* (,) E* (,)

A'' (,) B'' (,) C'' (,)

D'' (,) E'' (,)

a)

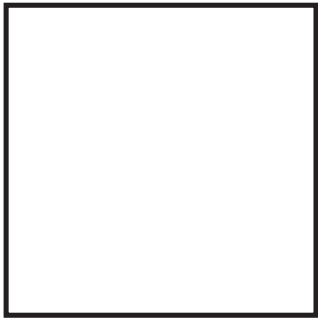

b)

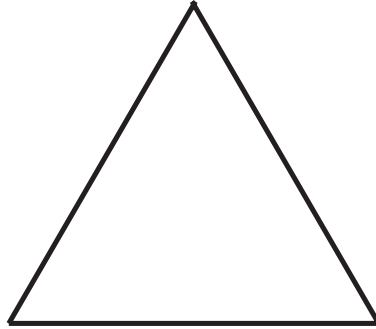

c)

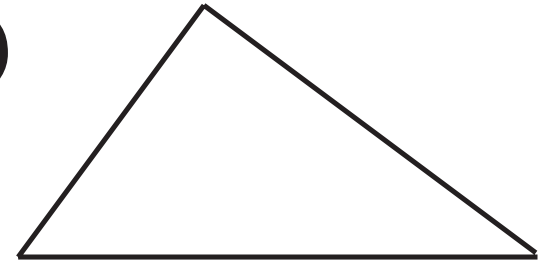

d)

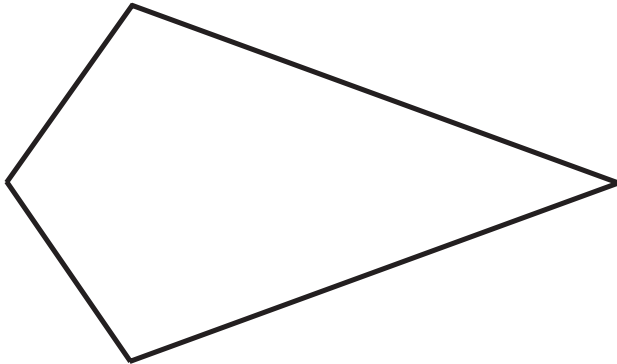

e)



f)

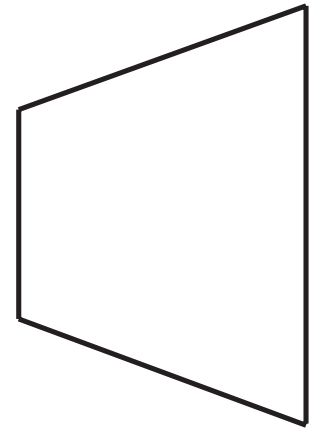

g)

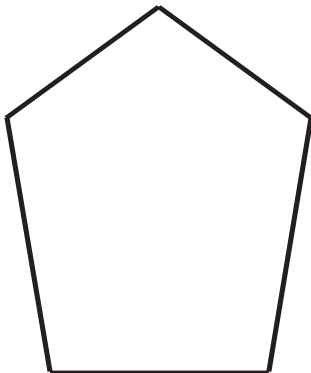

h)

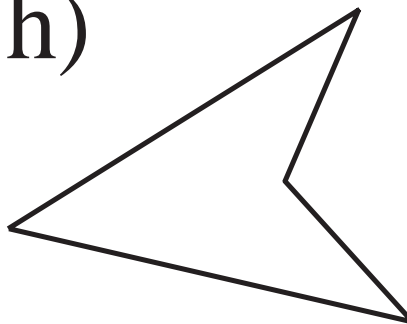

i)

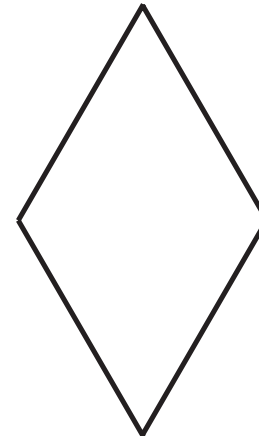

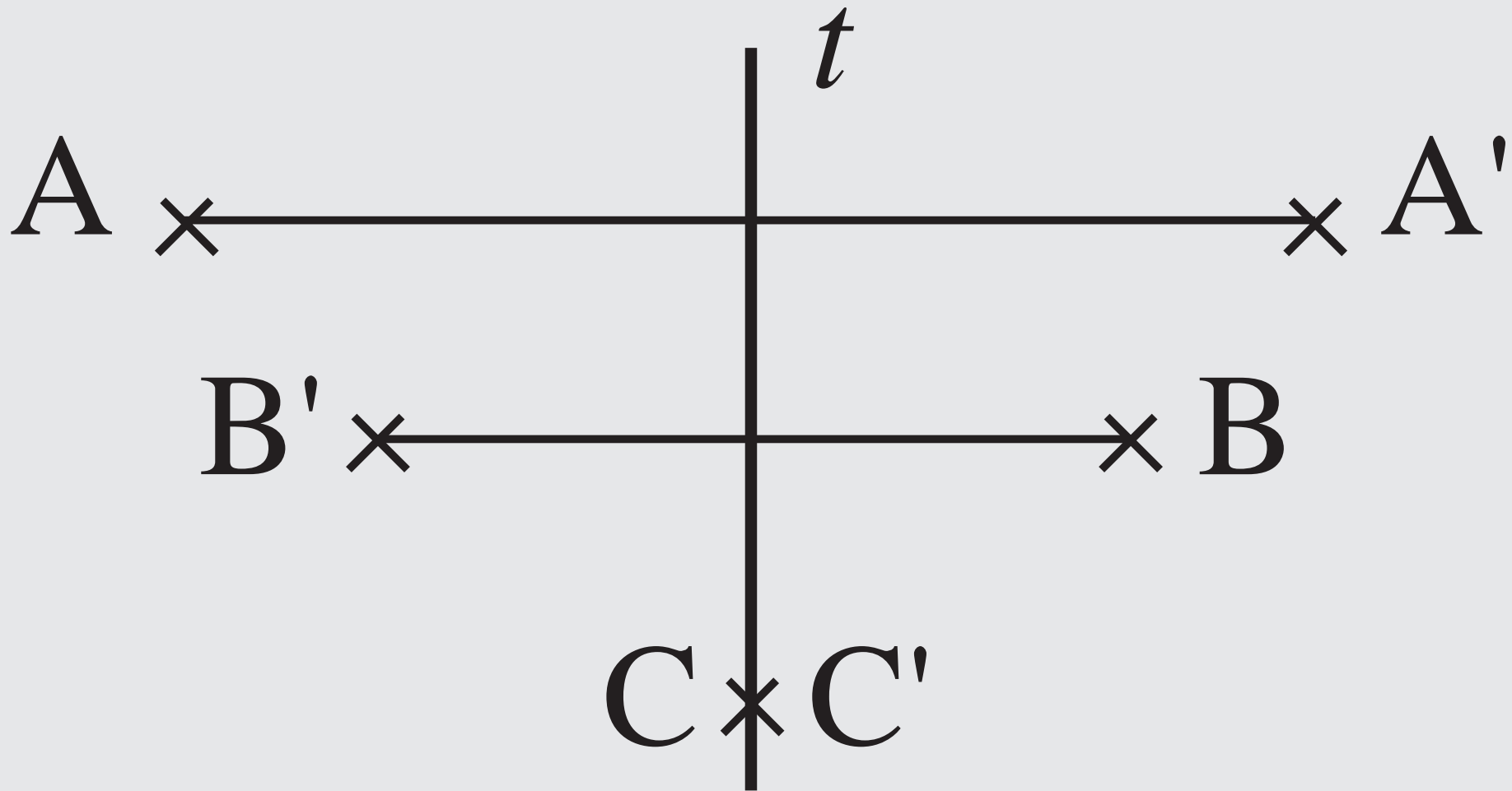

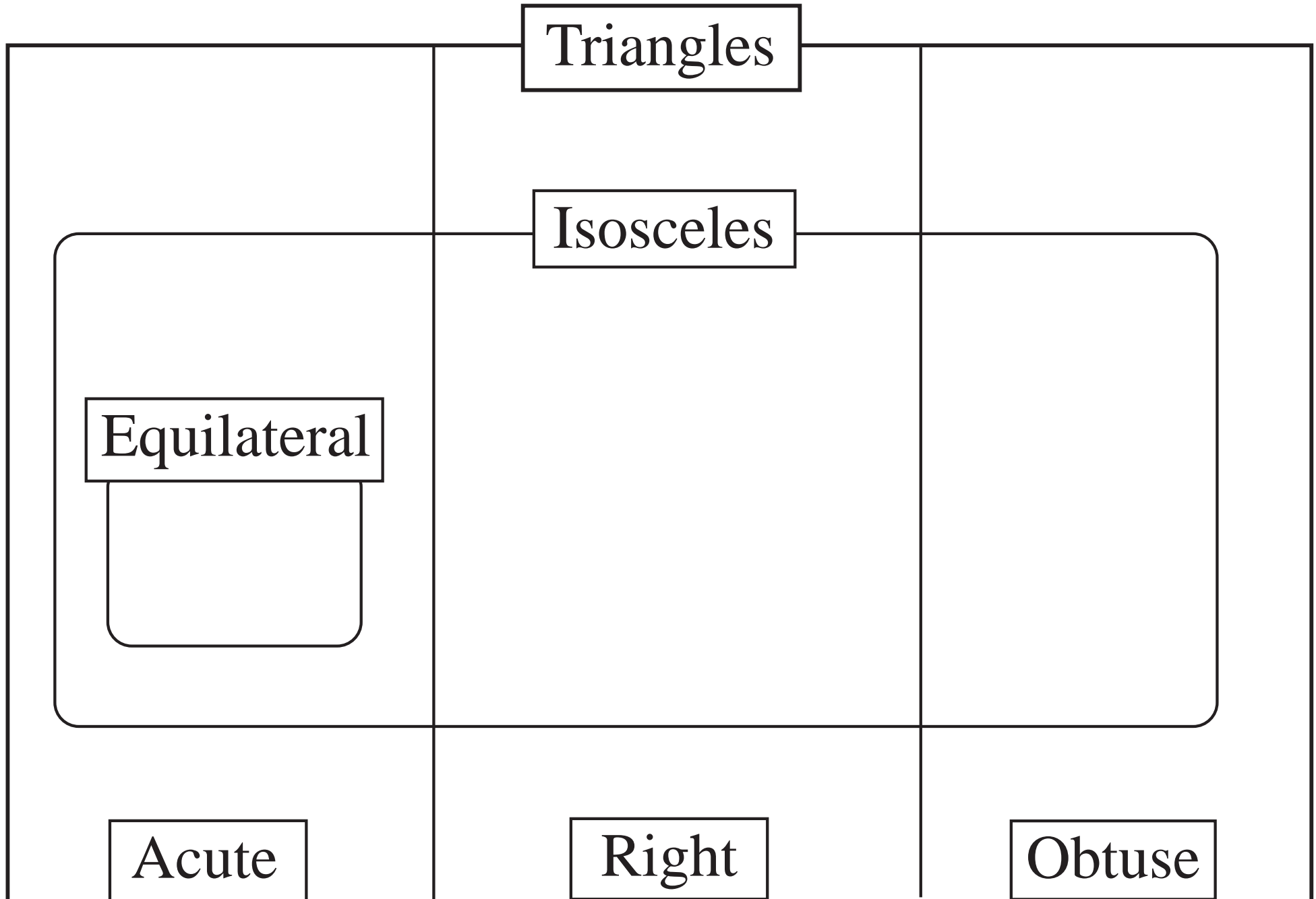

Quadrilaterals

At least 1 line of symmetry

At least 2 lines of symmetry

4 lines of symmetry

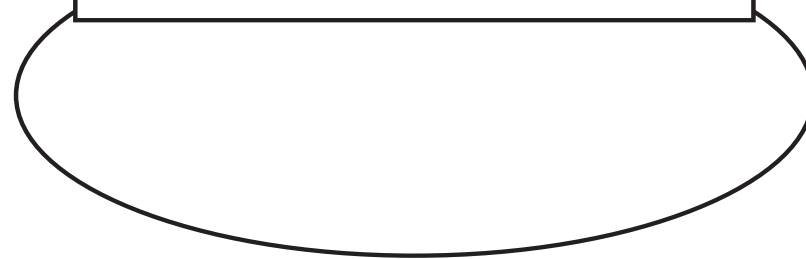

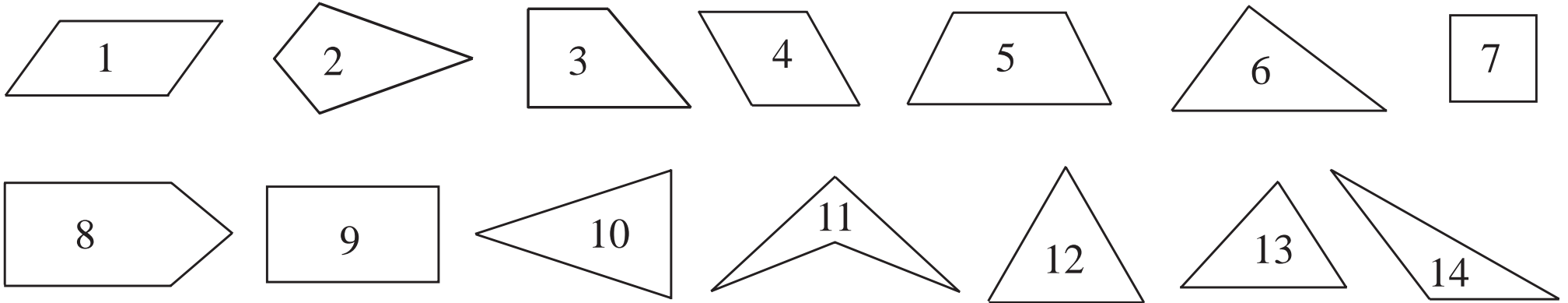

LP 88/3

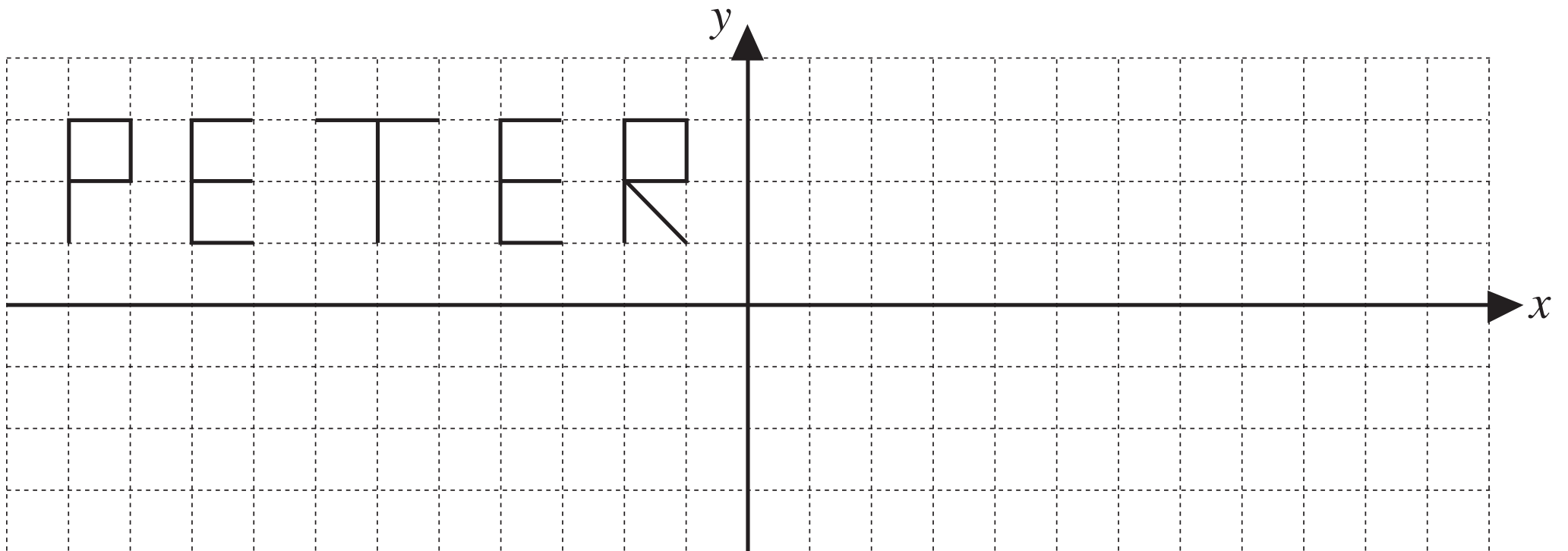

LP 88/4

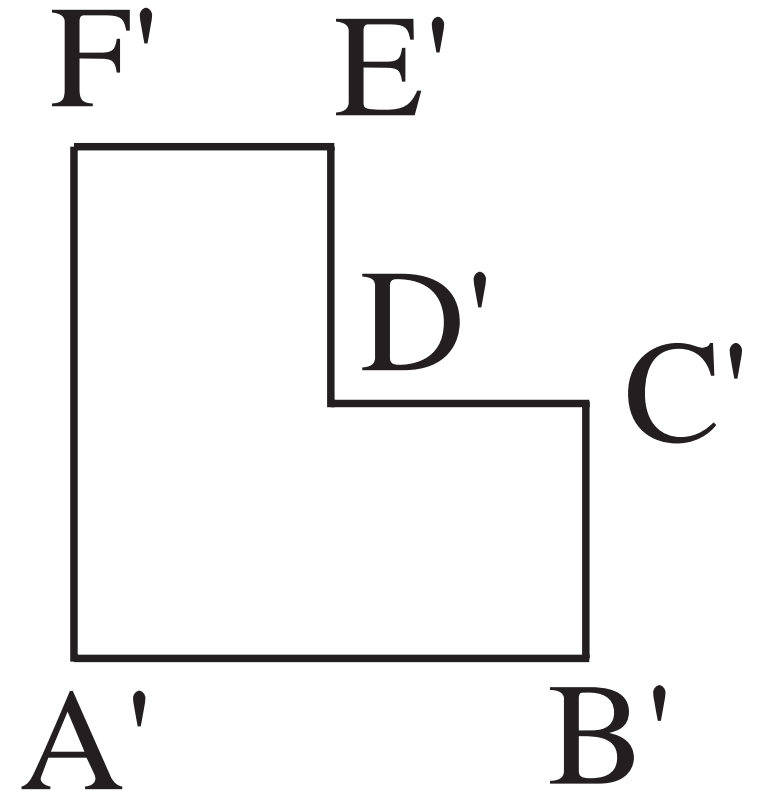
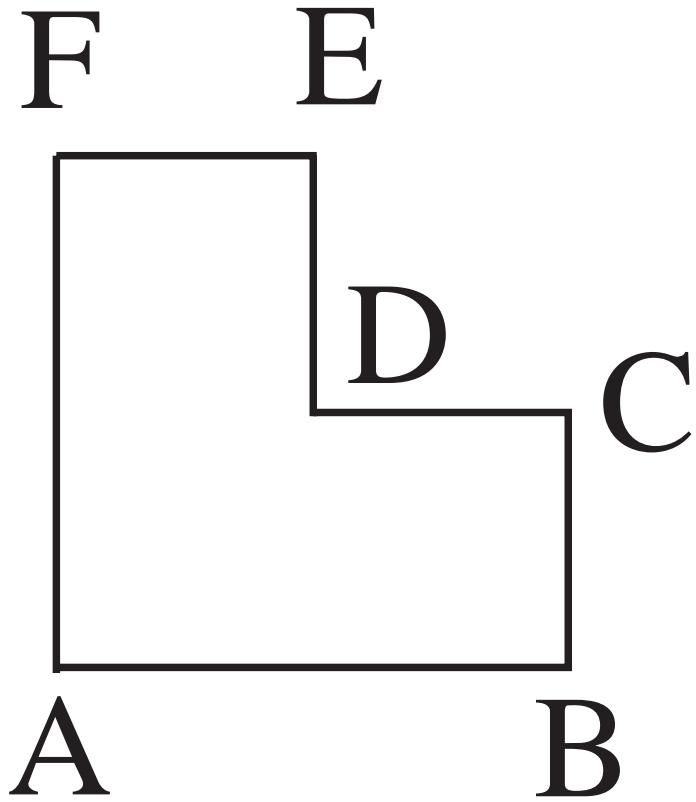

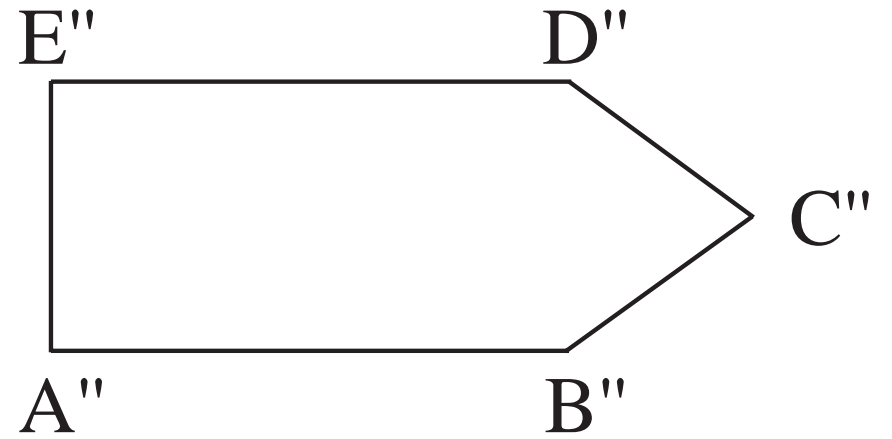
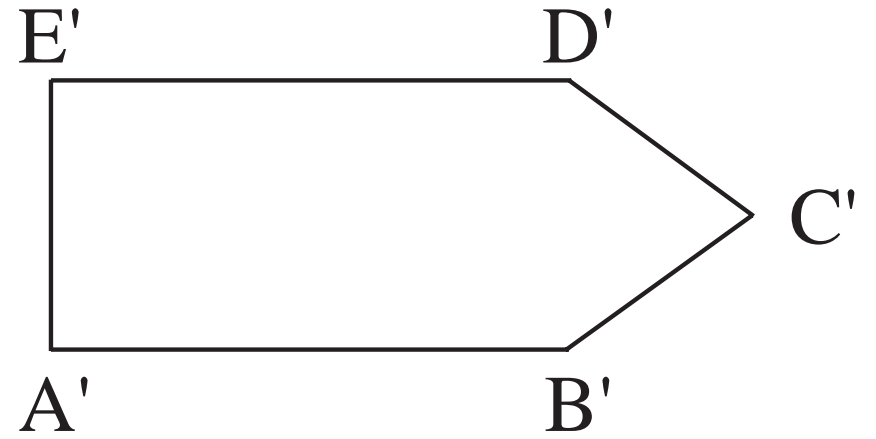
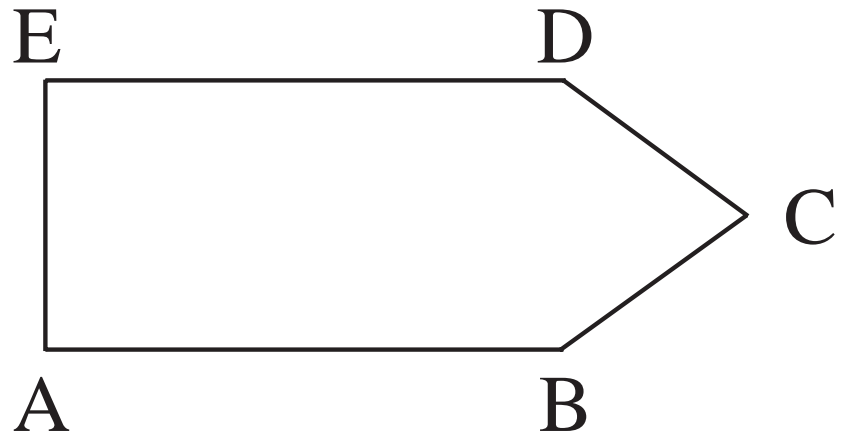

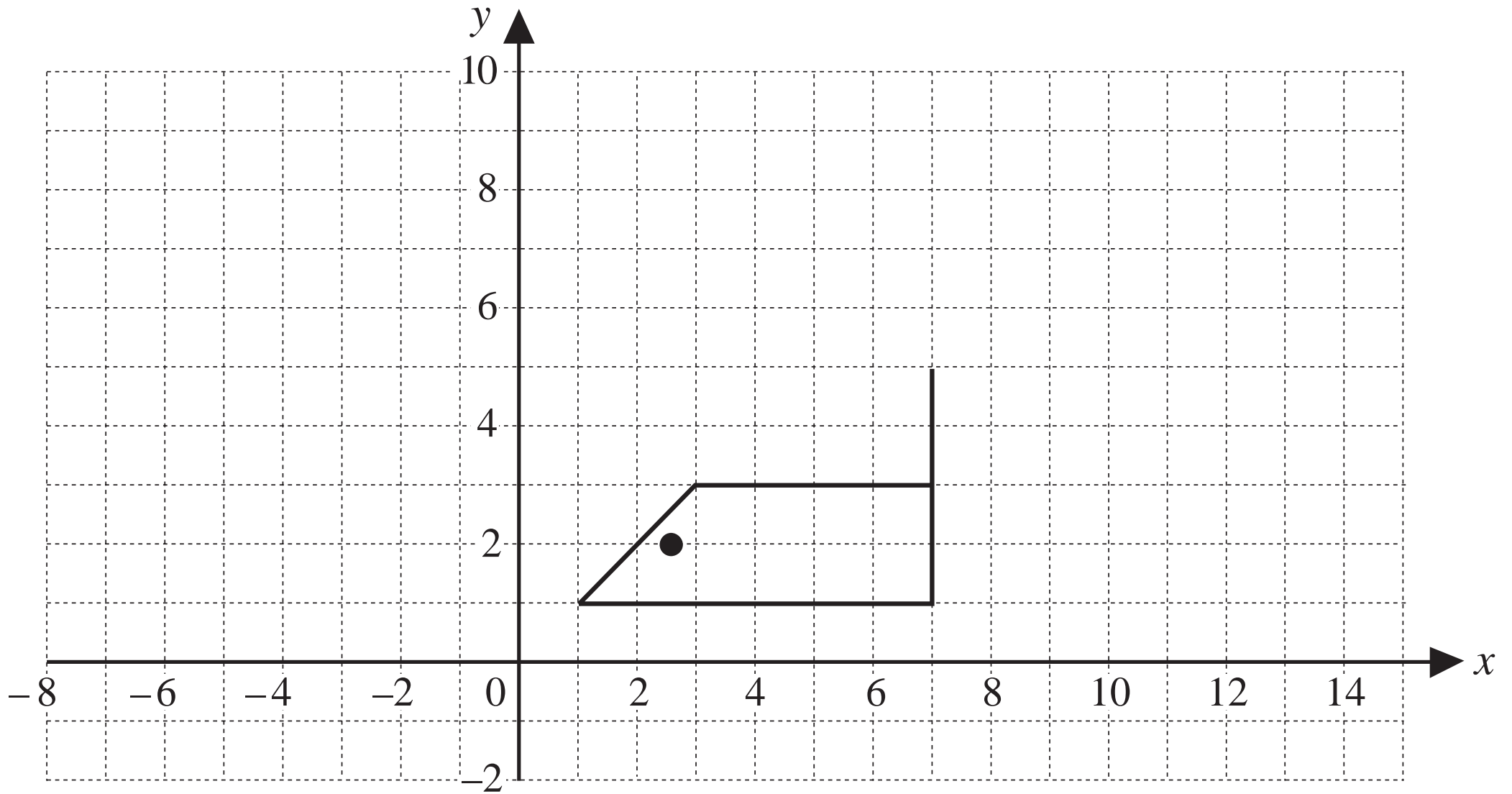

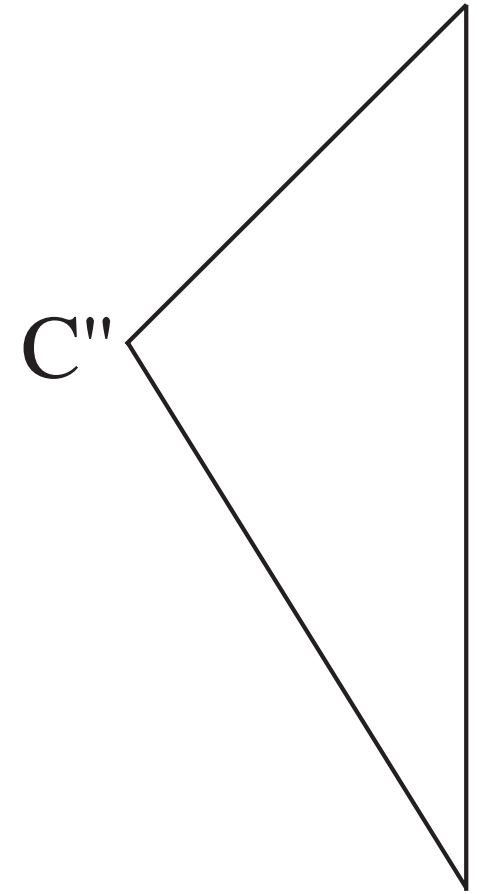
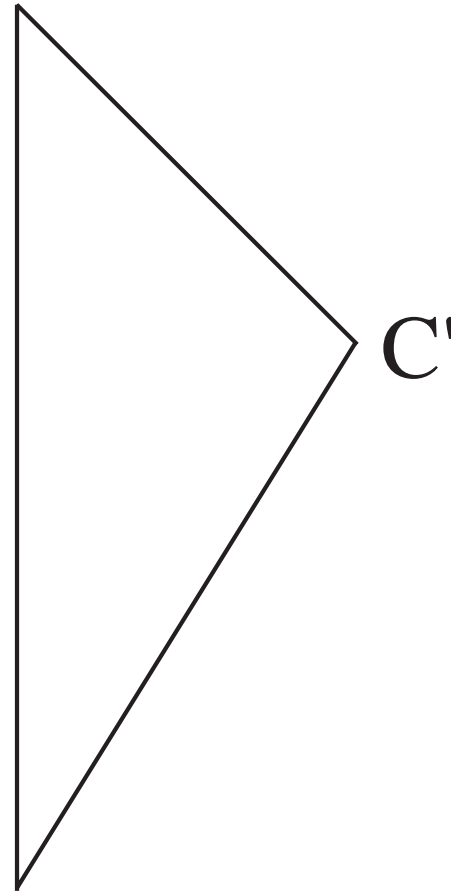
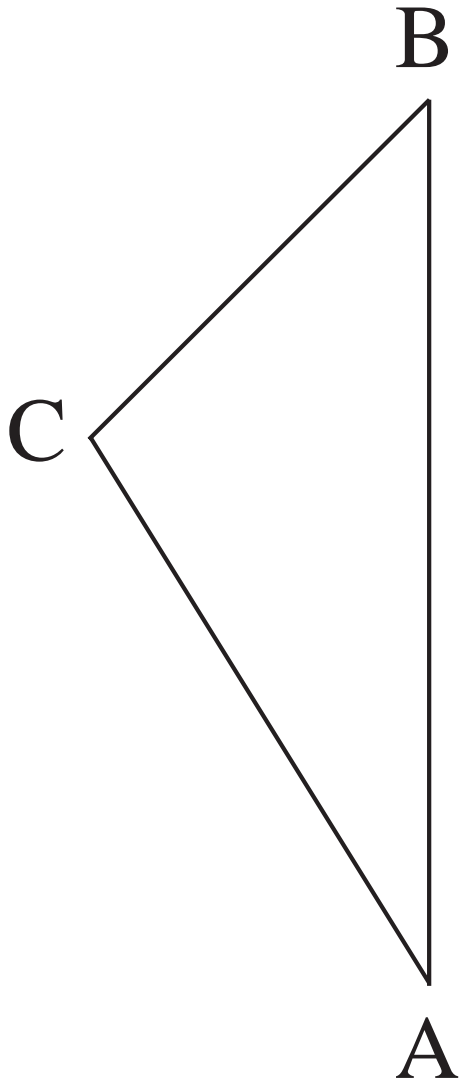

a)

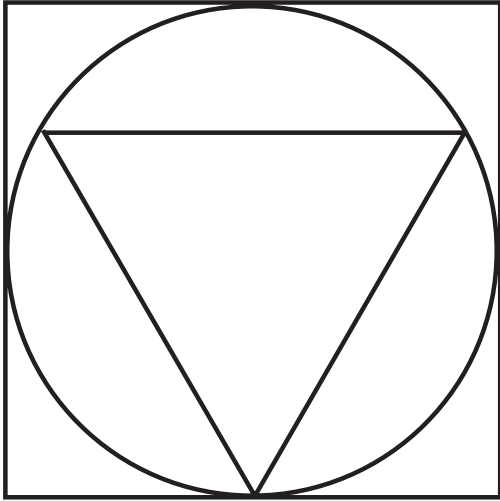

b)

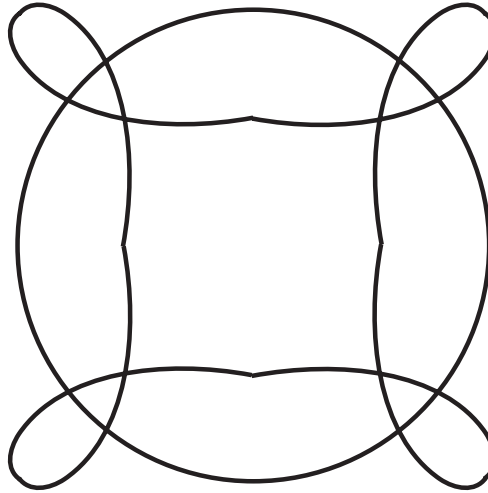

c)

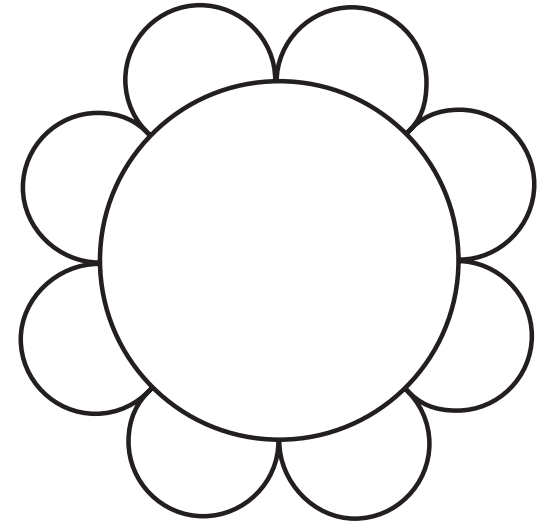

d)

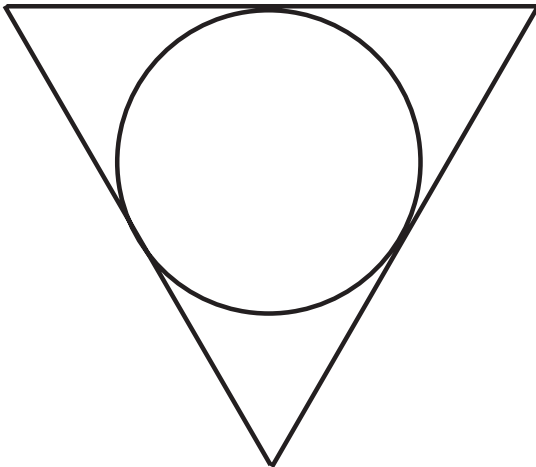

e)

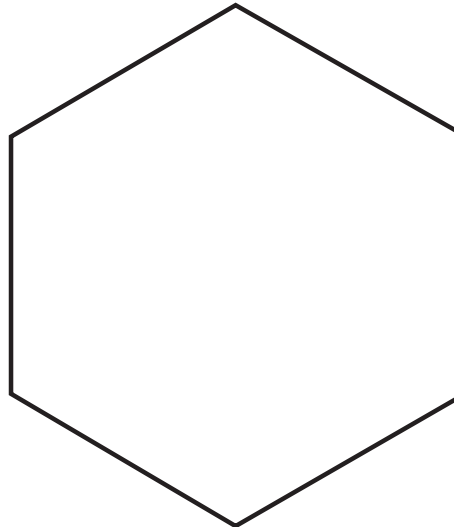

f)

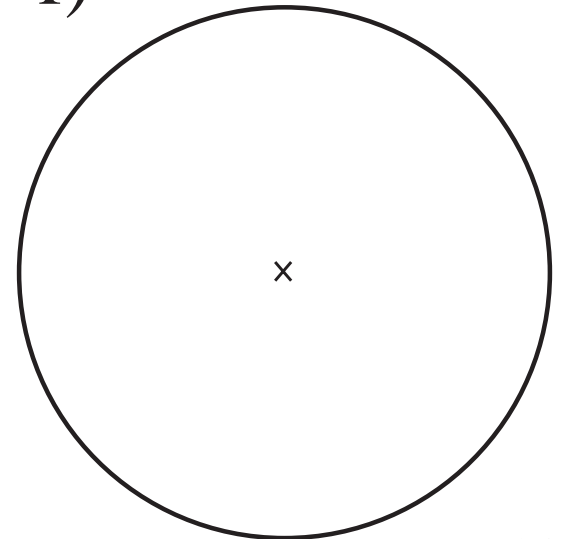

×
A

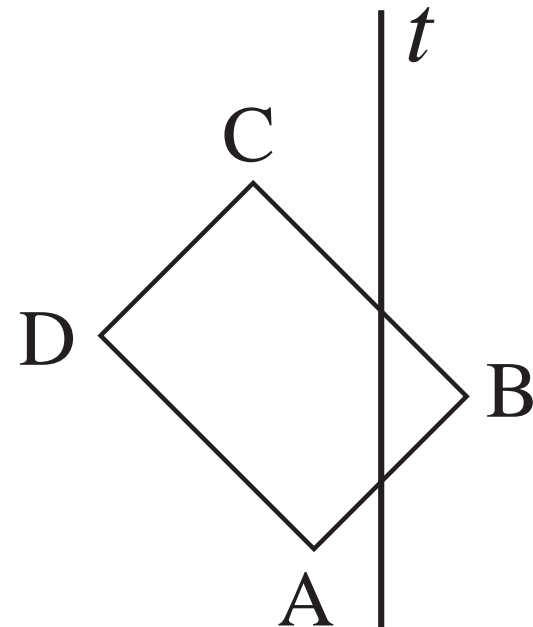
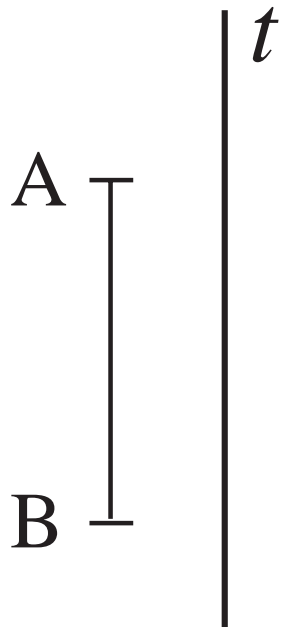
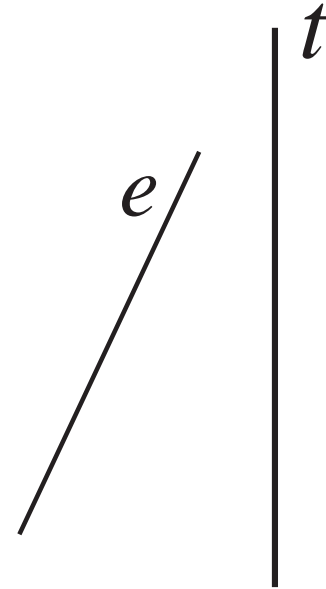

$\mathbb{R} \times$ $\begin{array}{c} \mathbb{P} \\ \times \\ \mathbb{Q} \end{array} \times e$

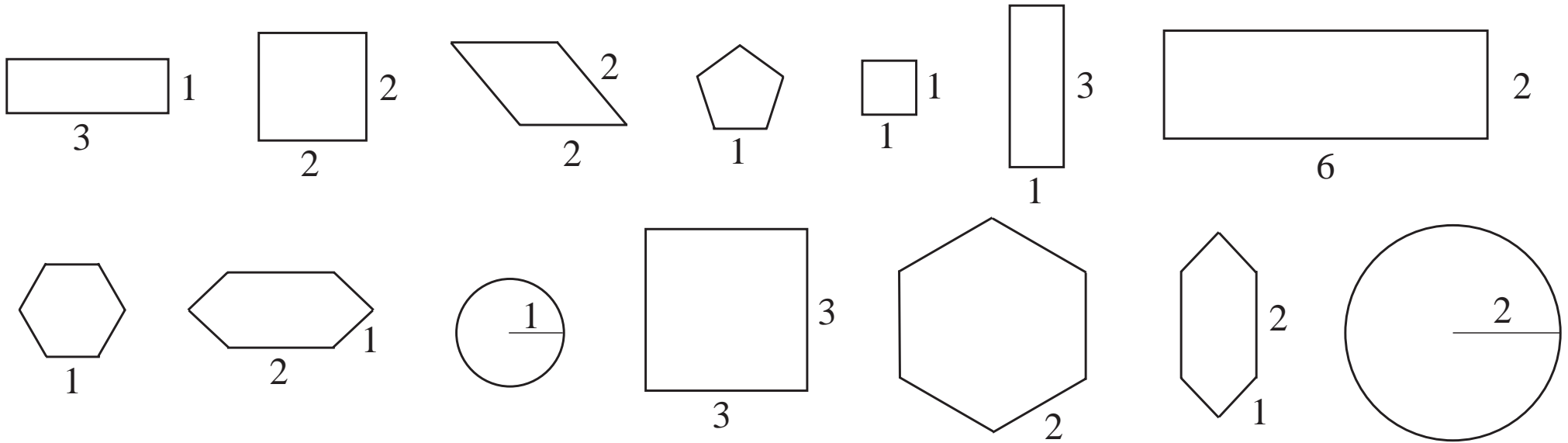

LP 89/4

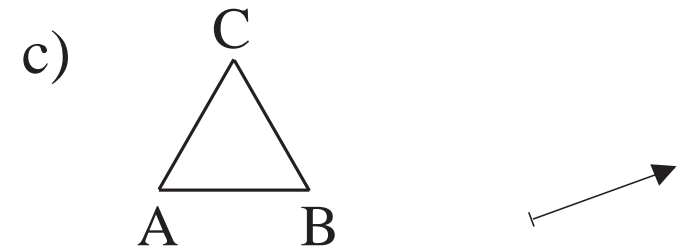
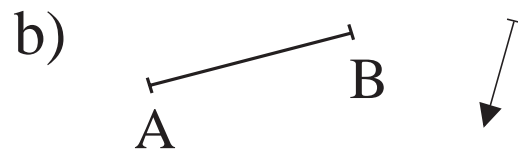

LP 89/5

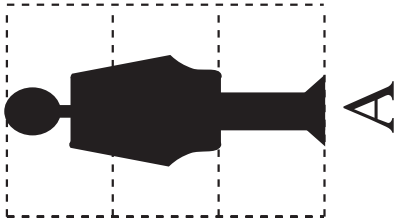

A

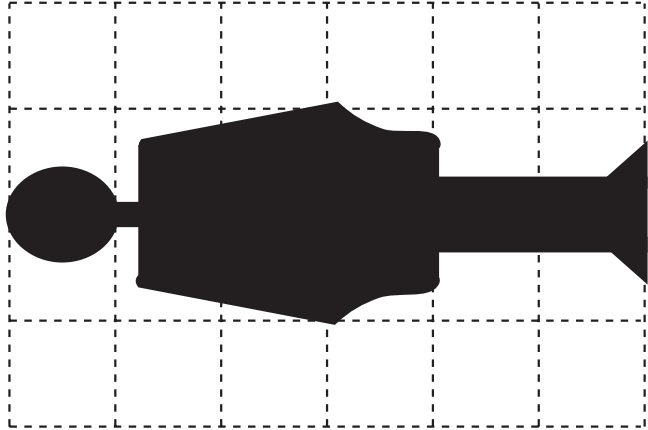

B

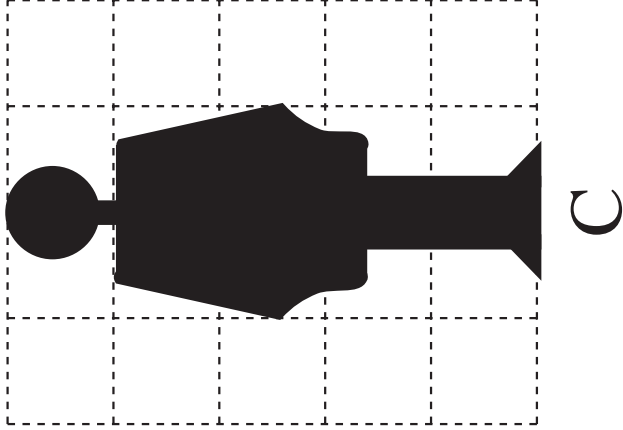

C

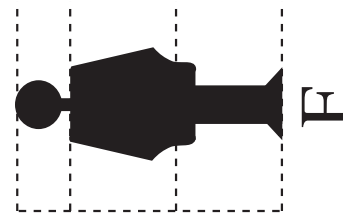

F

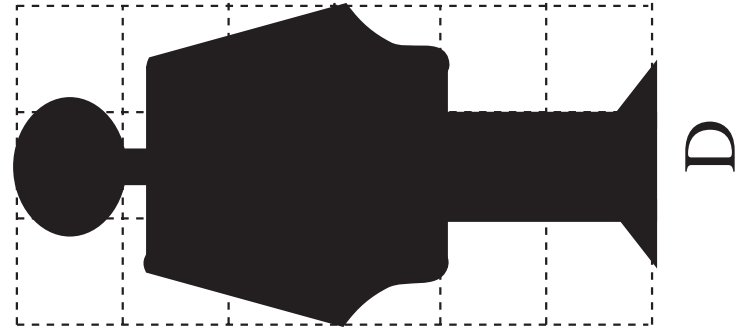

D



E

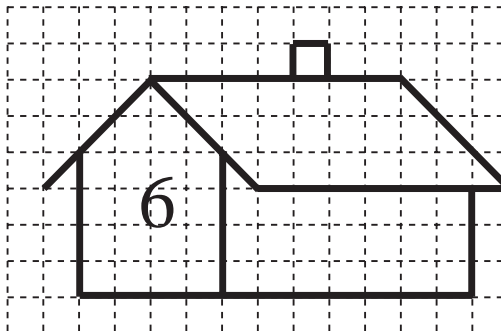
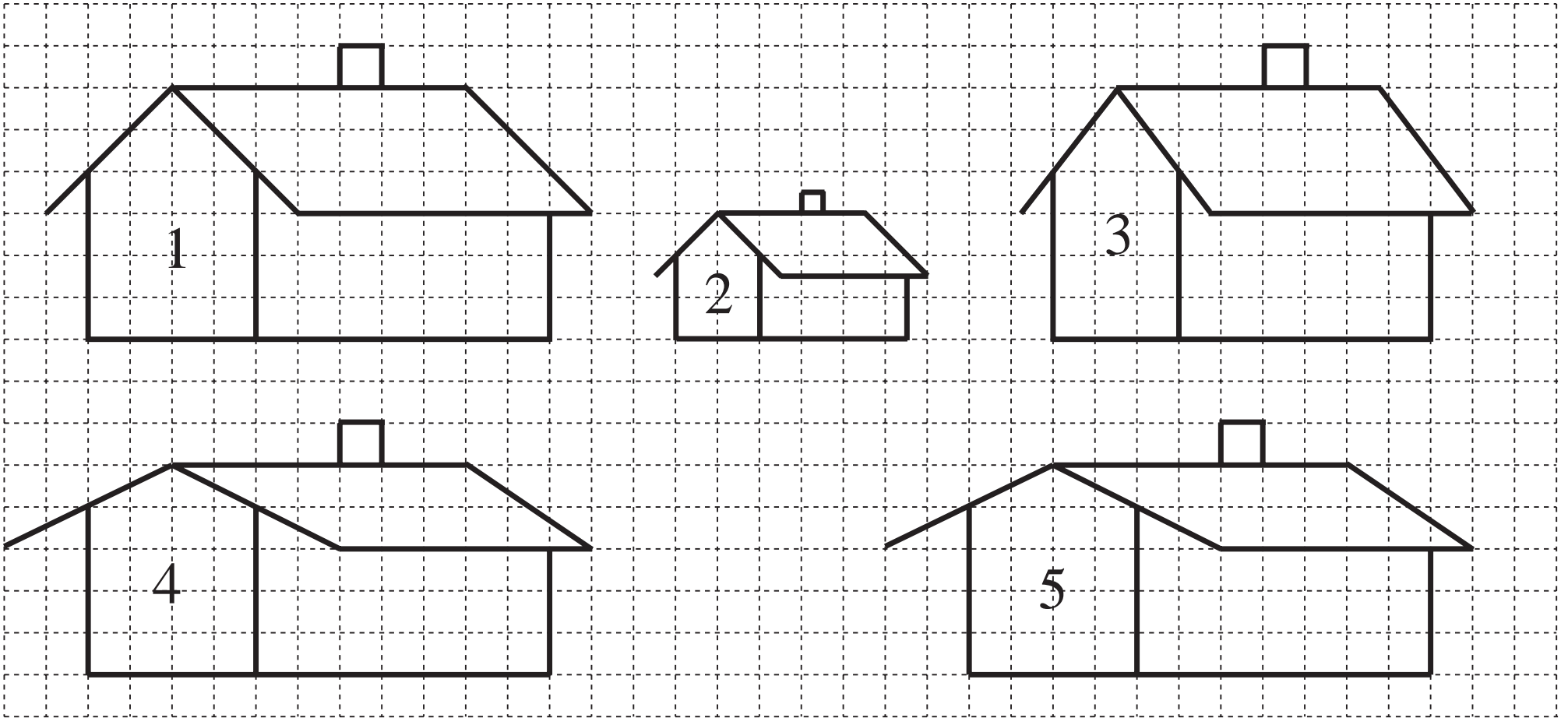

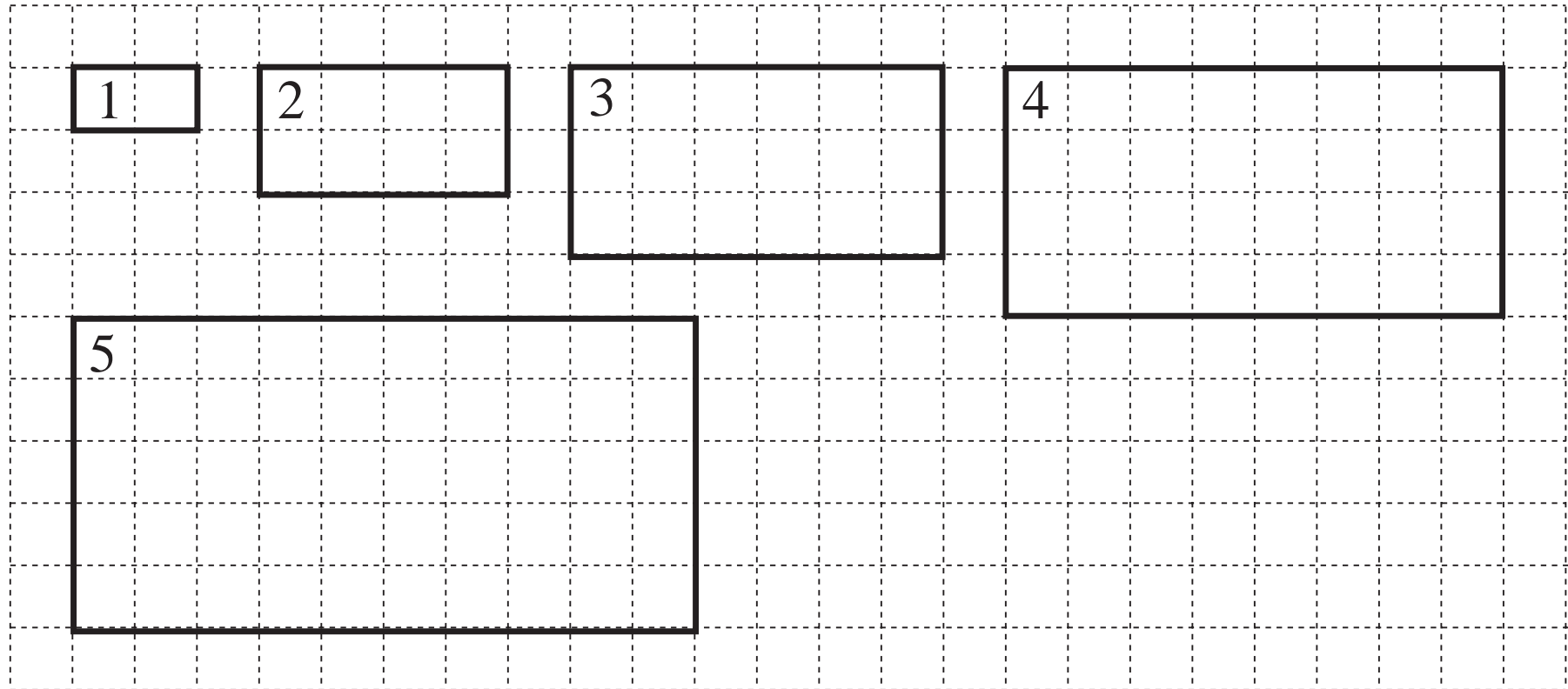

Shorter side	1	2	3	4	5	6	7	8	9	10
Longer side	2	4	6	8	10					
Perimeter (units)										
Area (unit squares)										

Shorter side	1	2	3	4	5	6	7	8	9	10
Longer side	2	4	6	8	10					
Perimeter (units)										
Area (unit squares)										



Shorter side	1	2	3	4	5	6	7	8	9	10
Longer side	2	4	6	8	10					
Perimeter (units)										
Area (unit squares)										

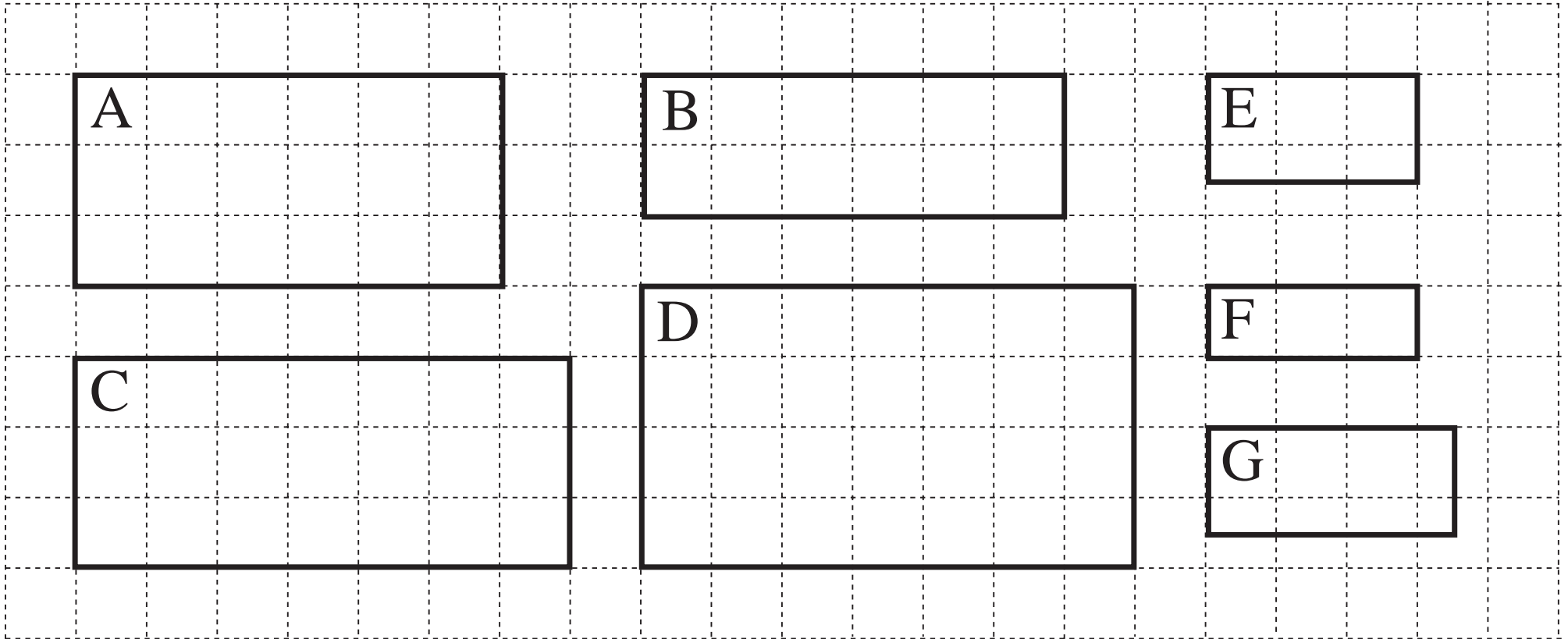



LP 90/1

a)

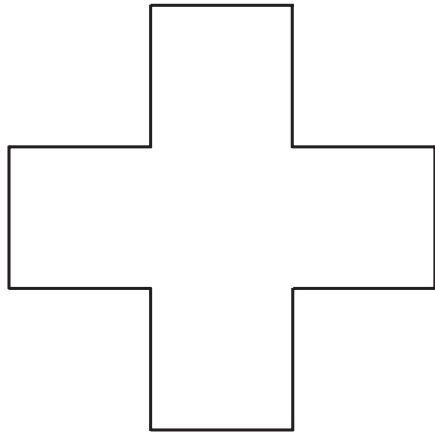

b)

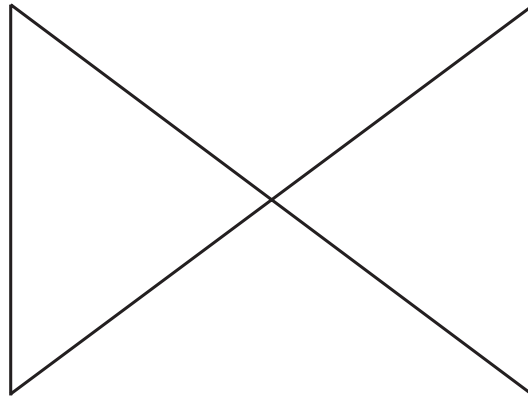

c)

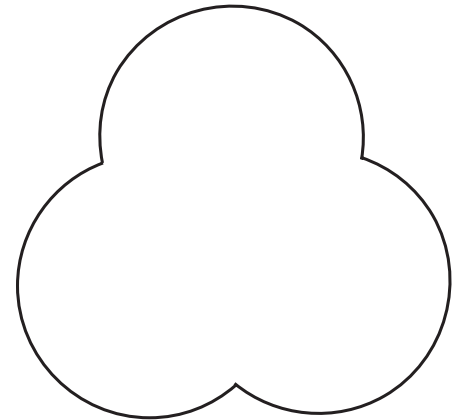

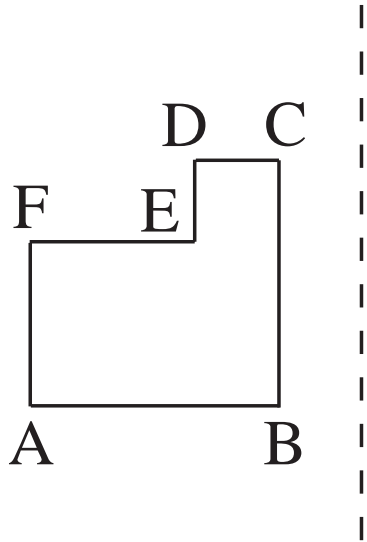
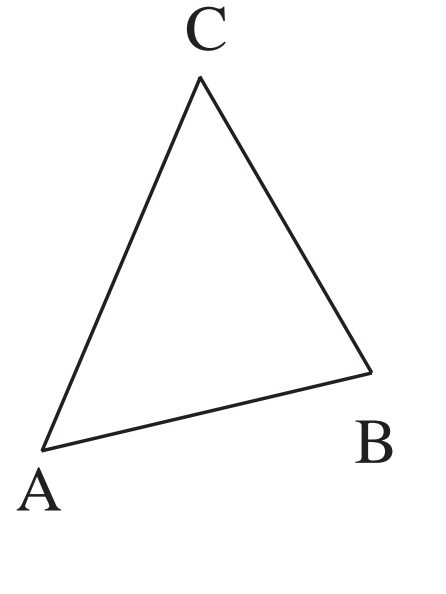
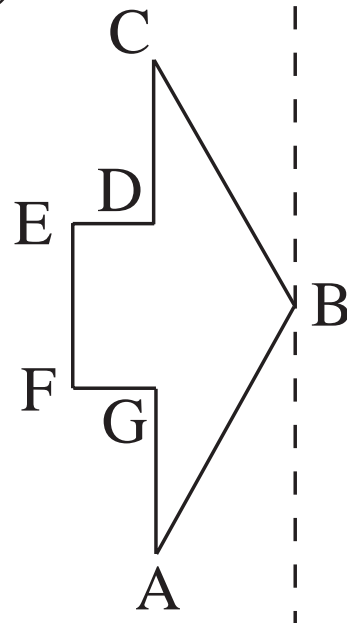
a) *mirror line*b) *mirror line*c) *mirror line*

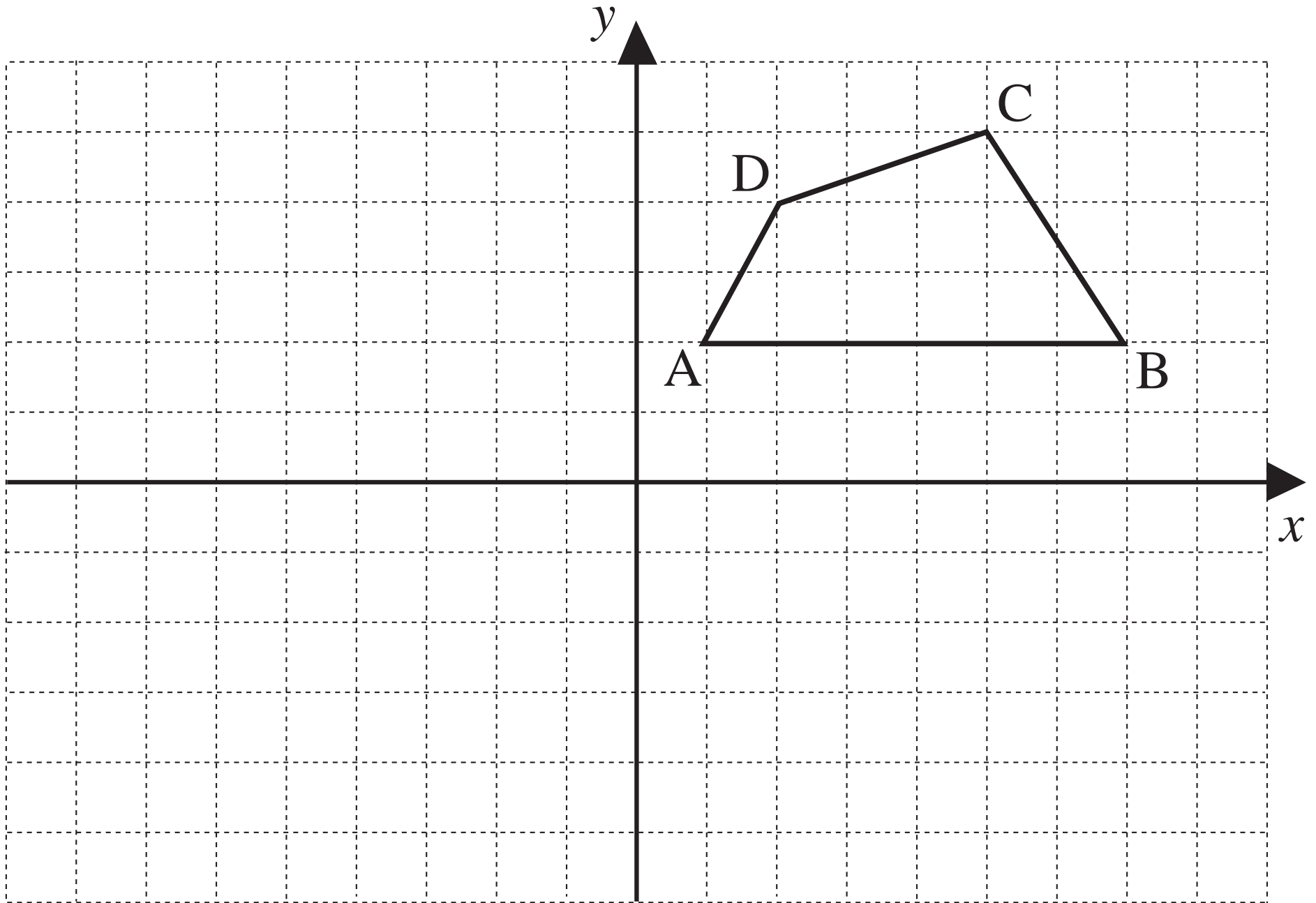

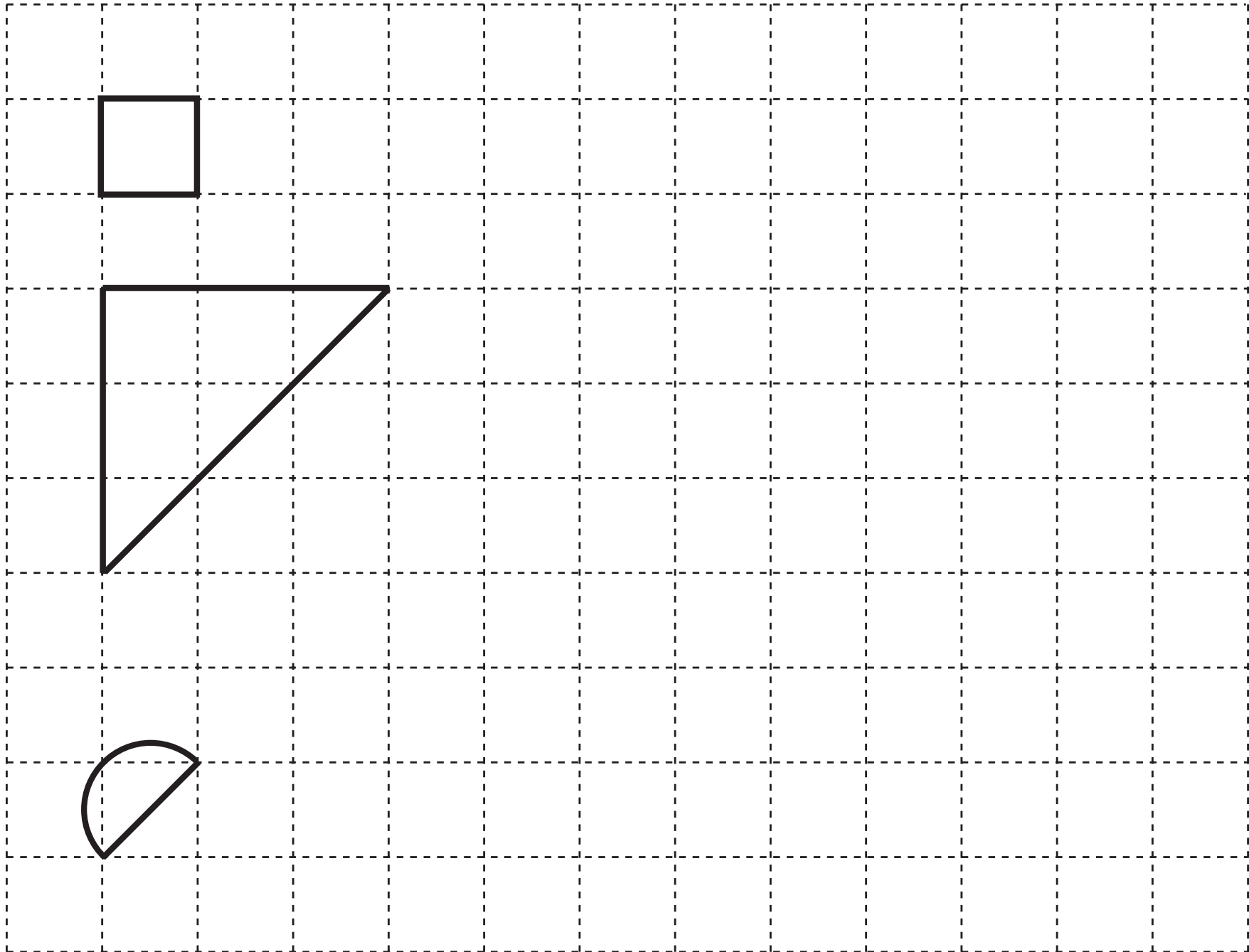

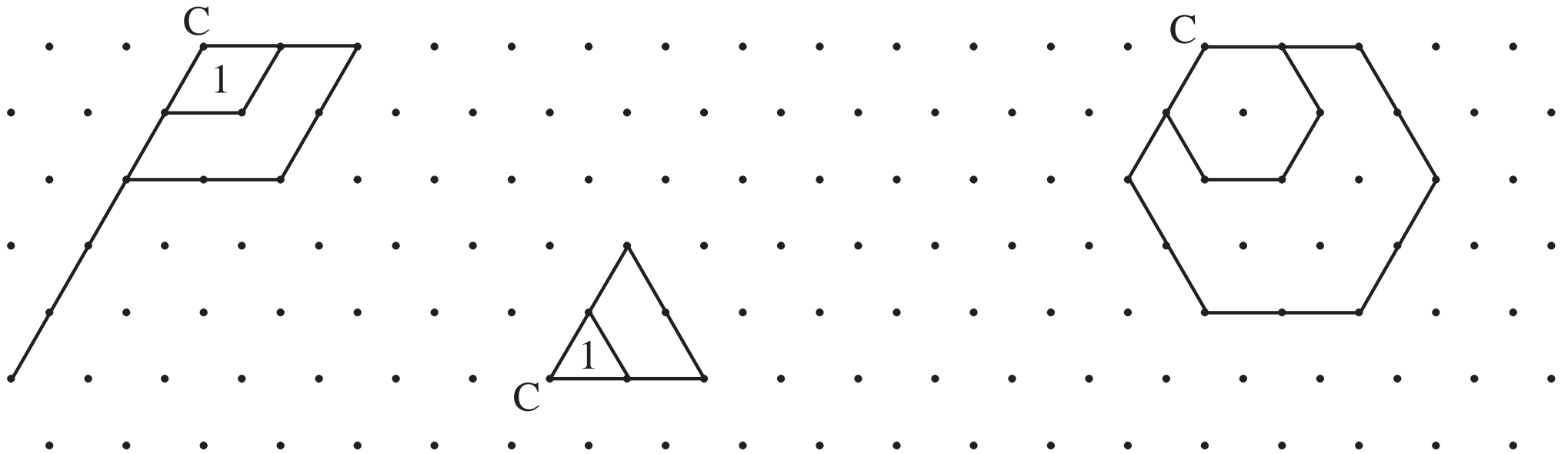

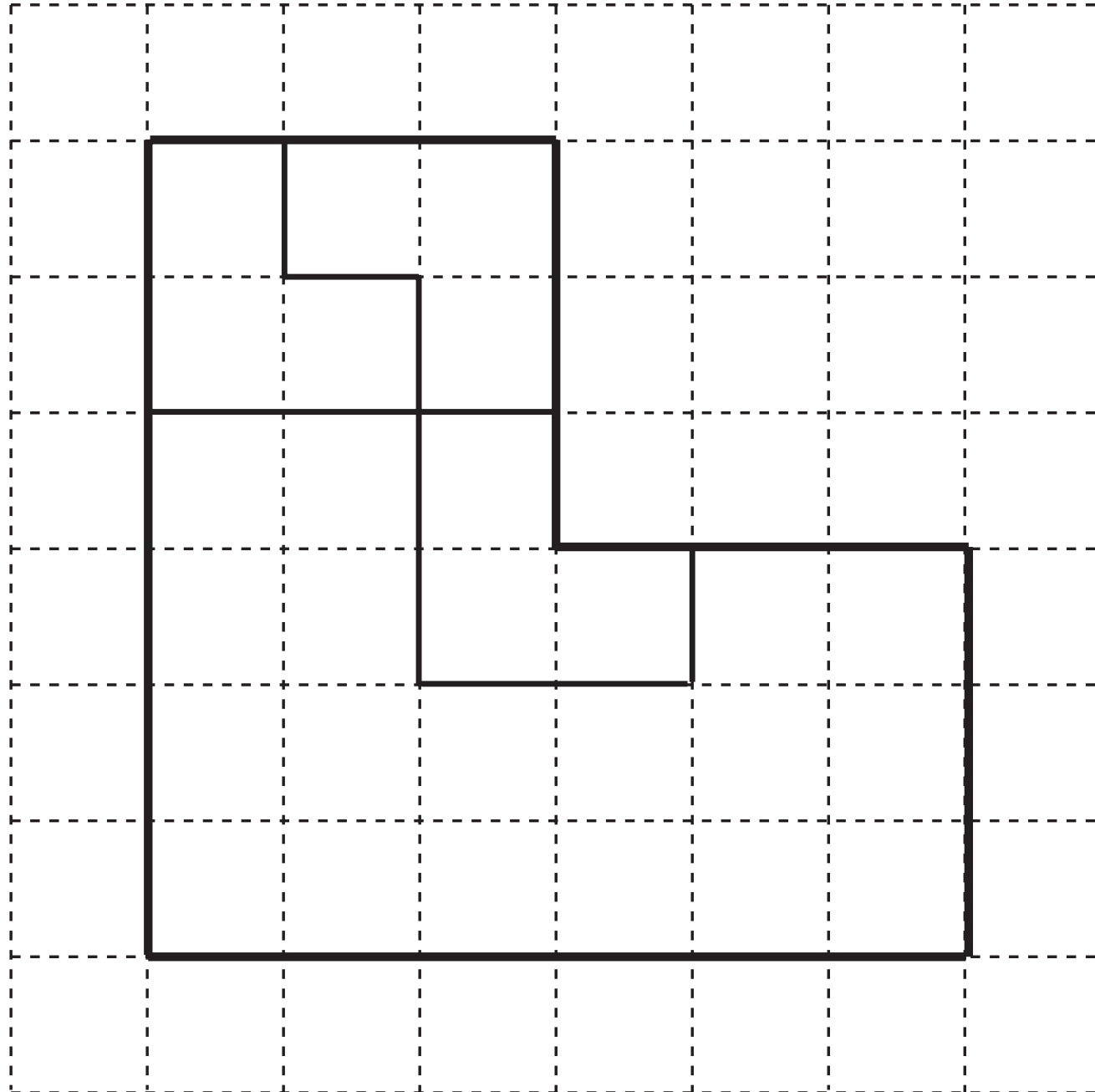

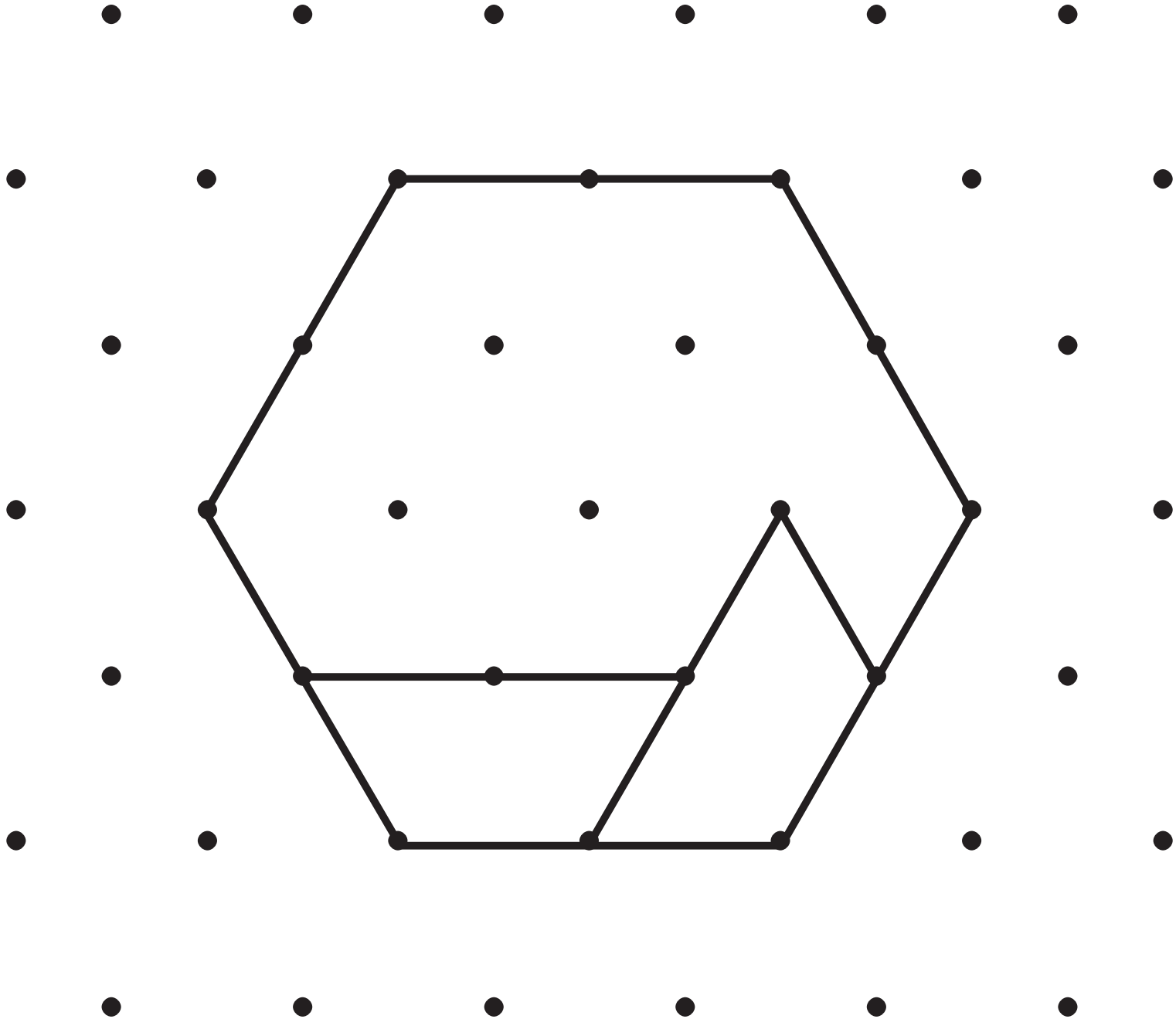

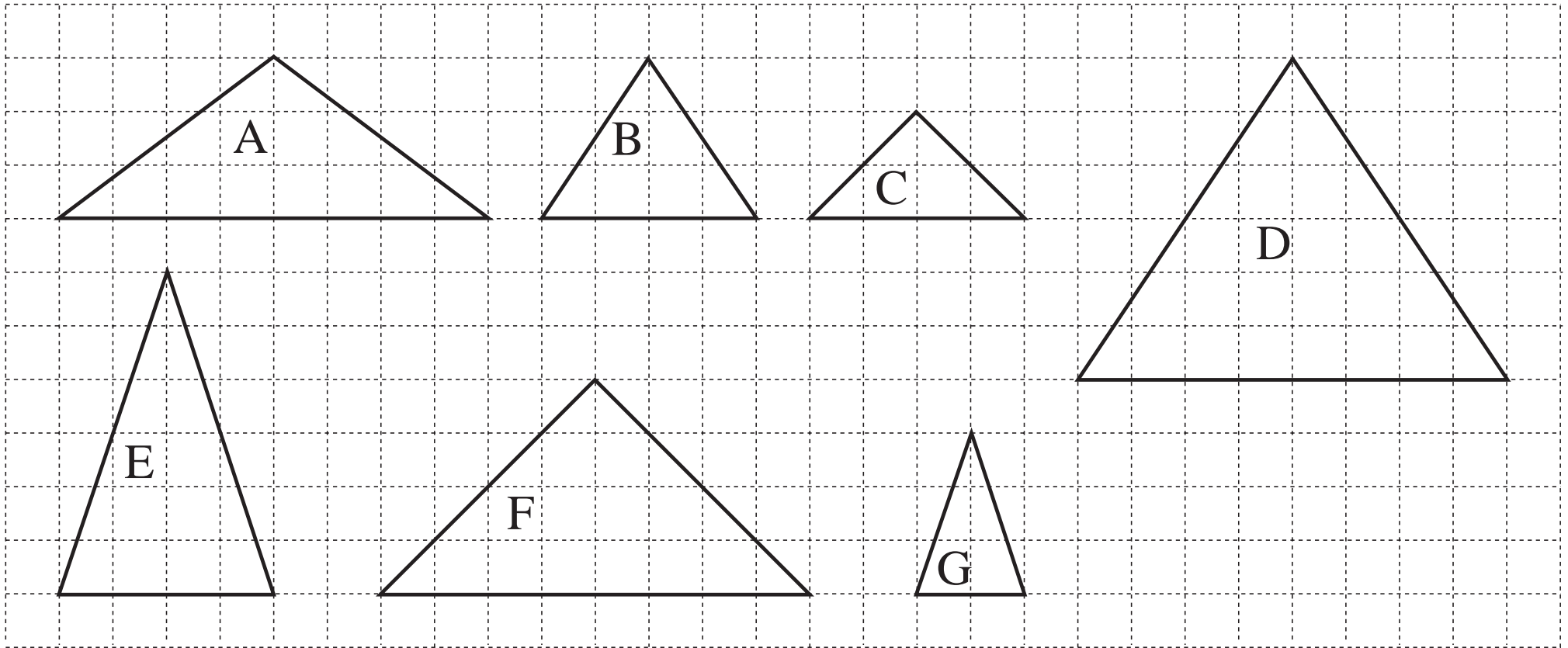

a)

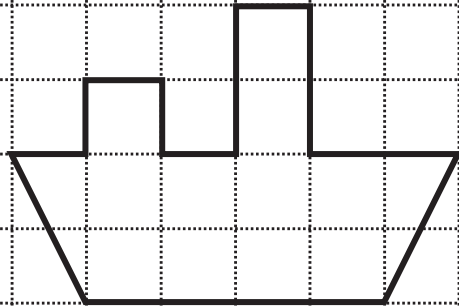

a)

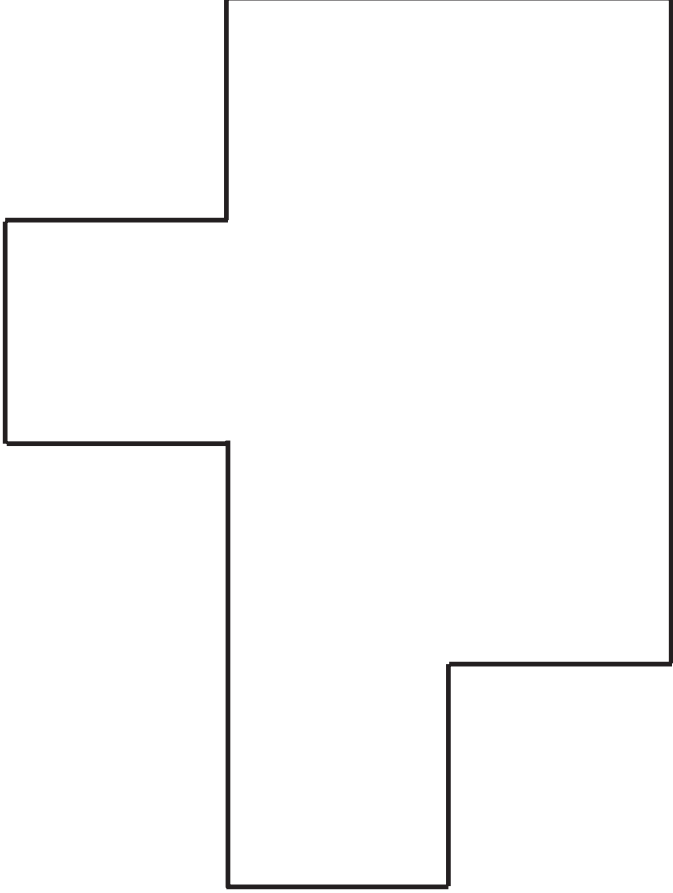

Scale 1 : 1000

b)

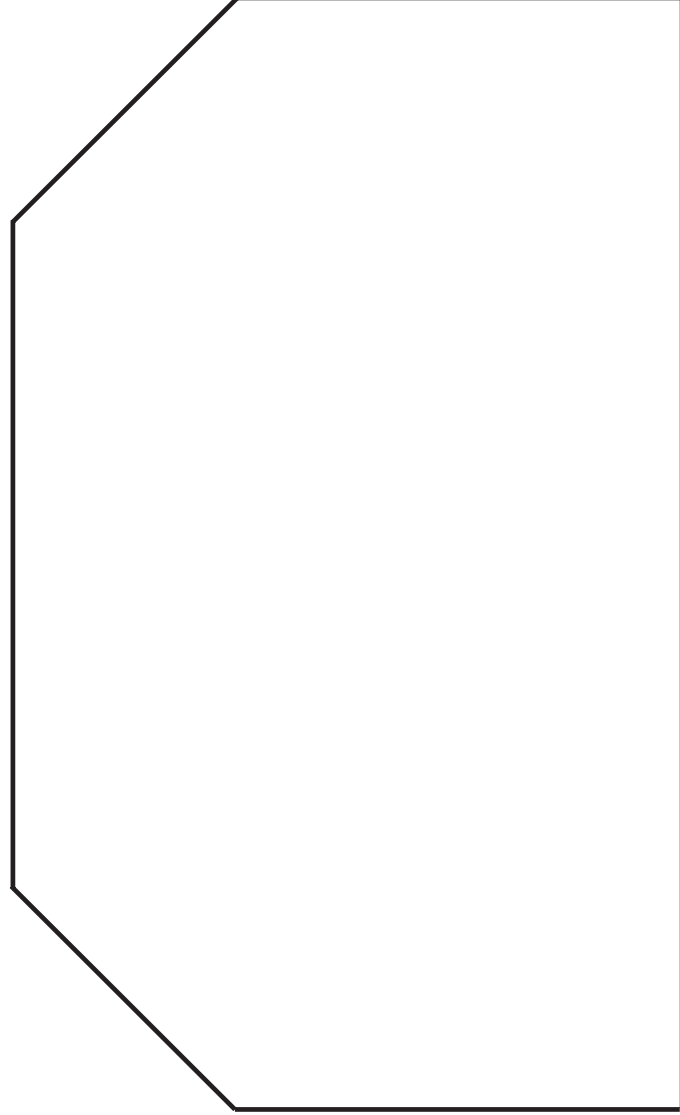

Scale 1 : 2000

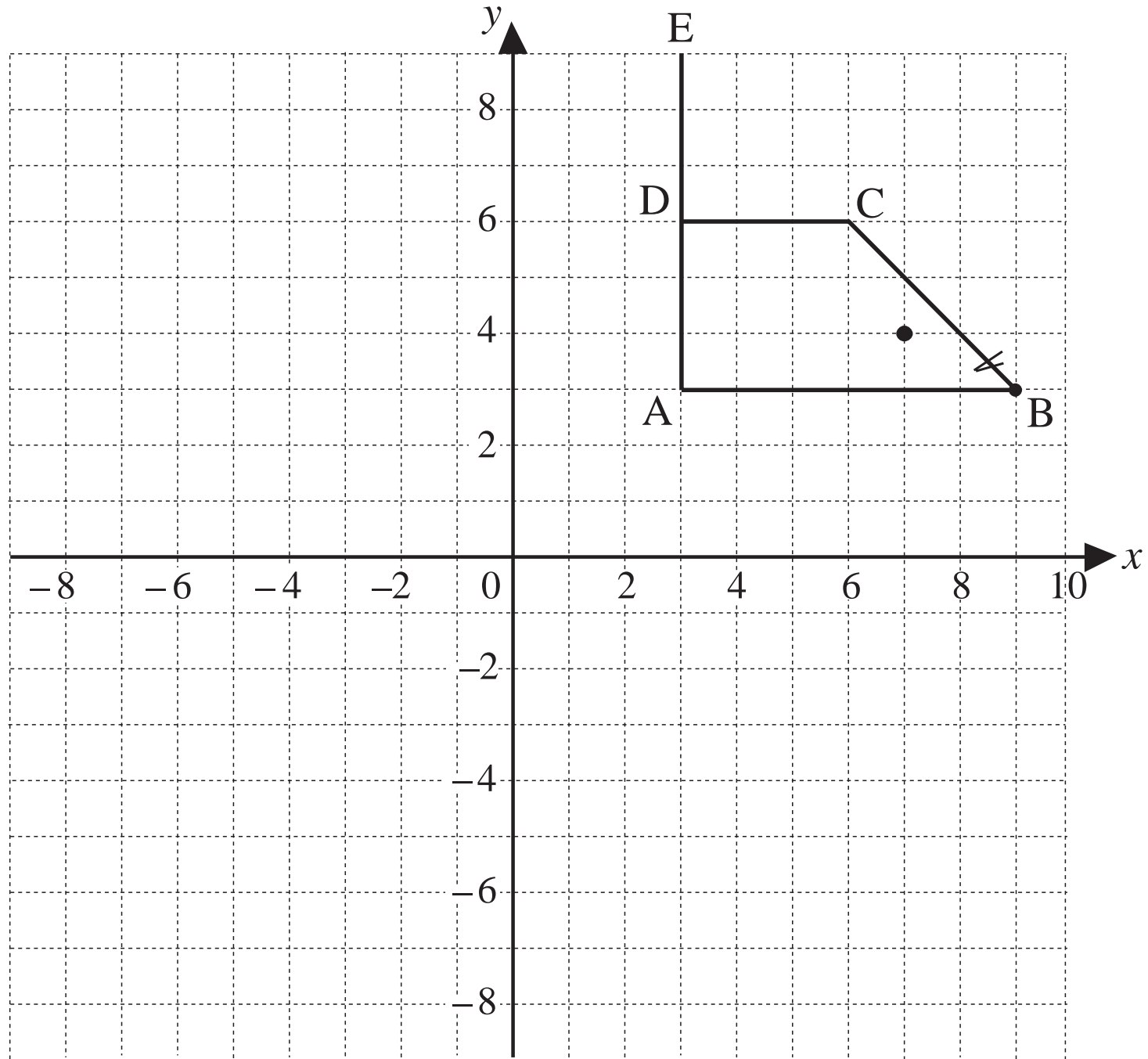

a)

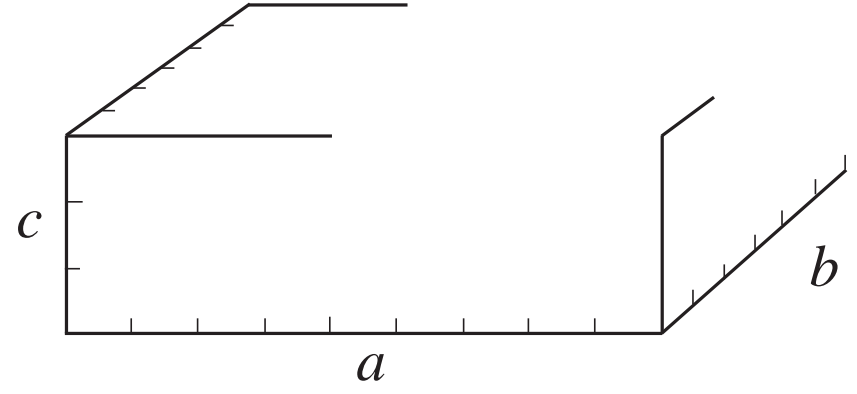
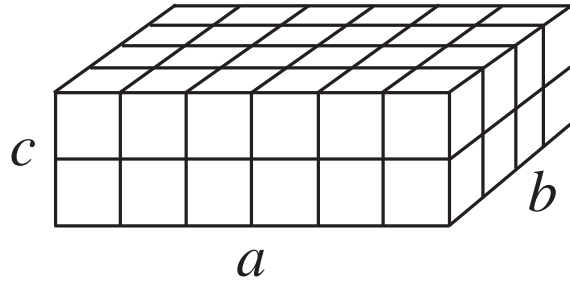
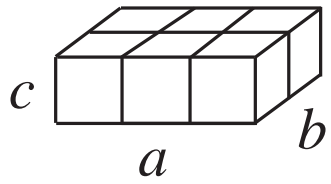

b)

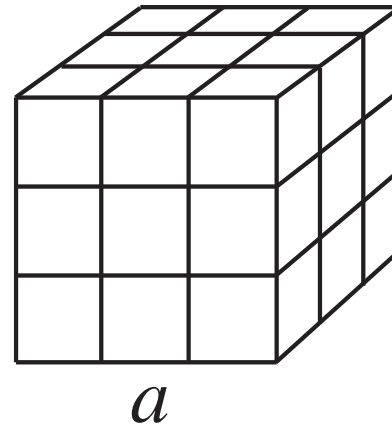
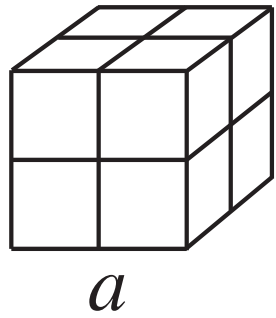
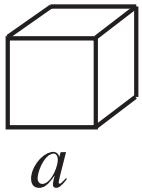

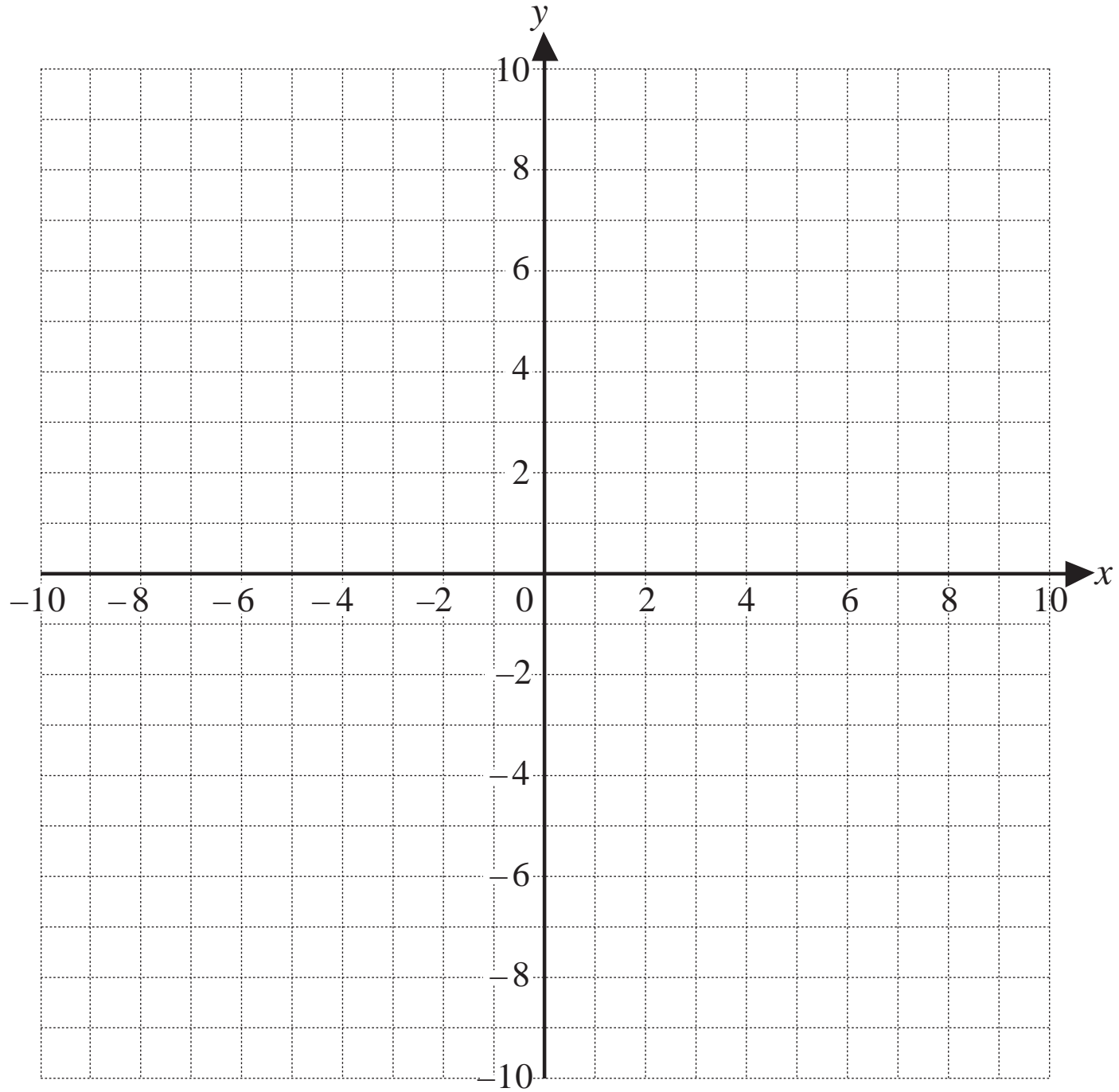

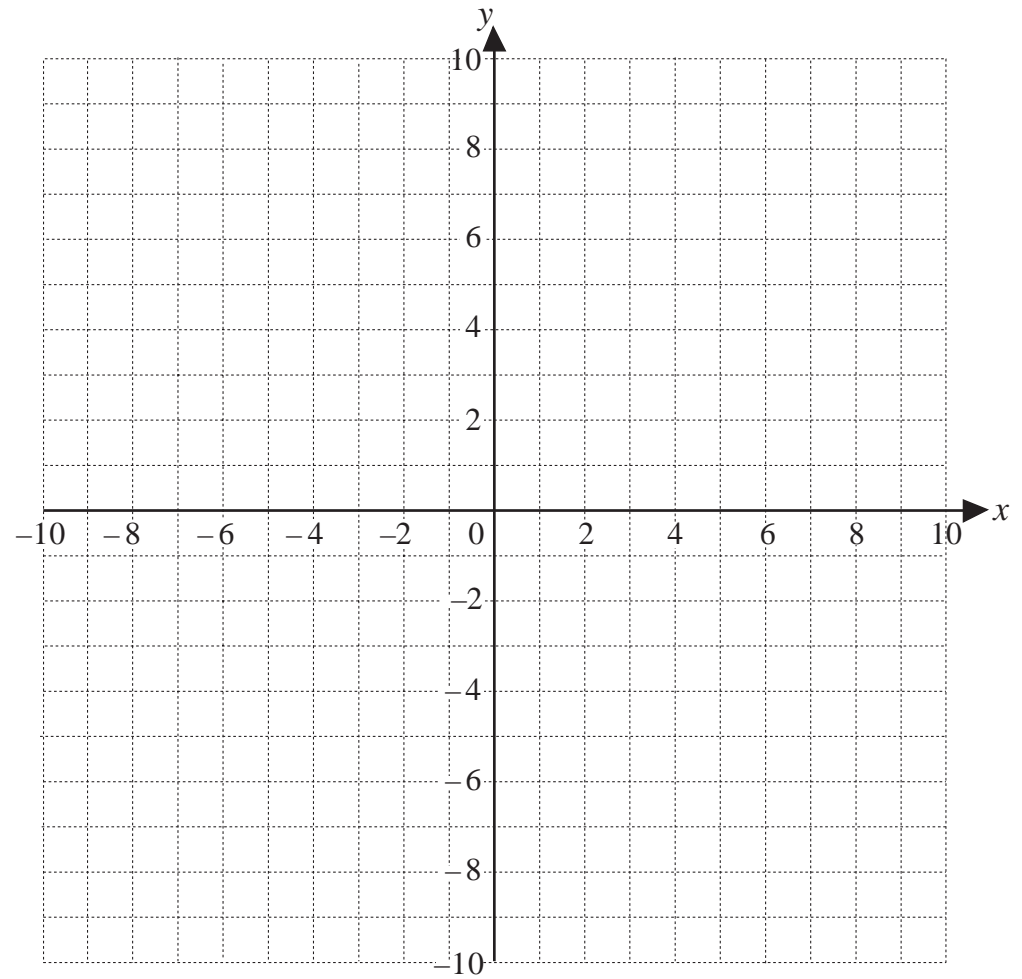
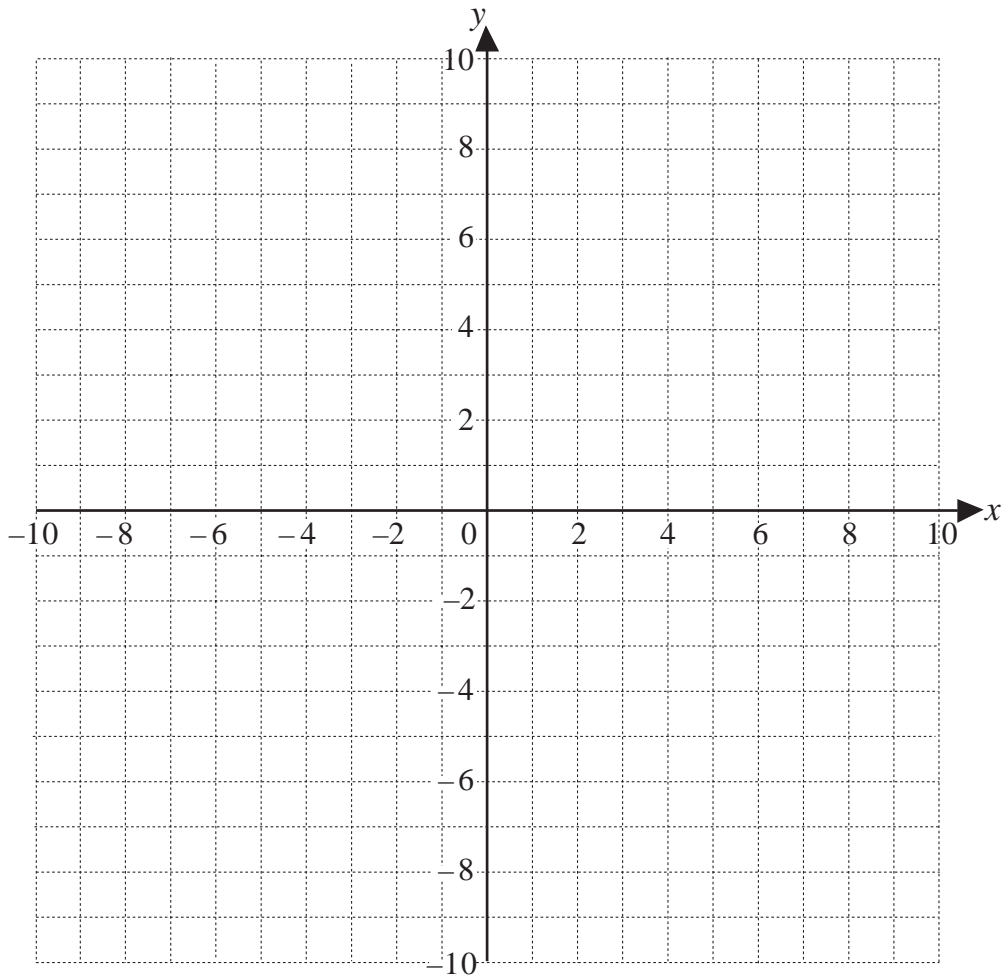

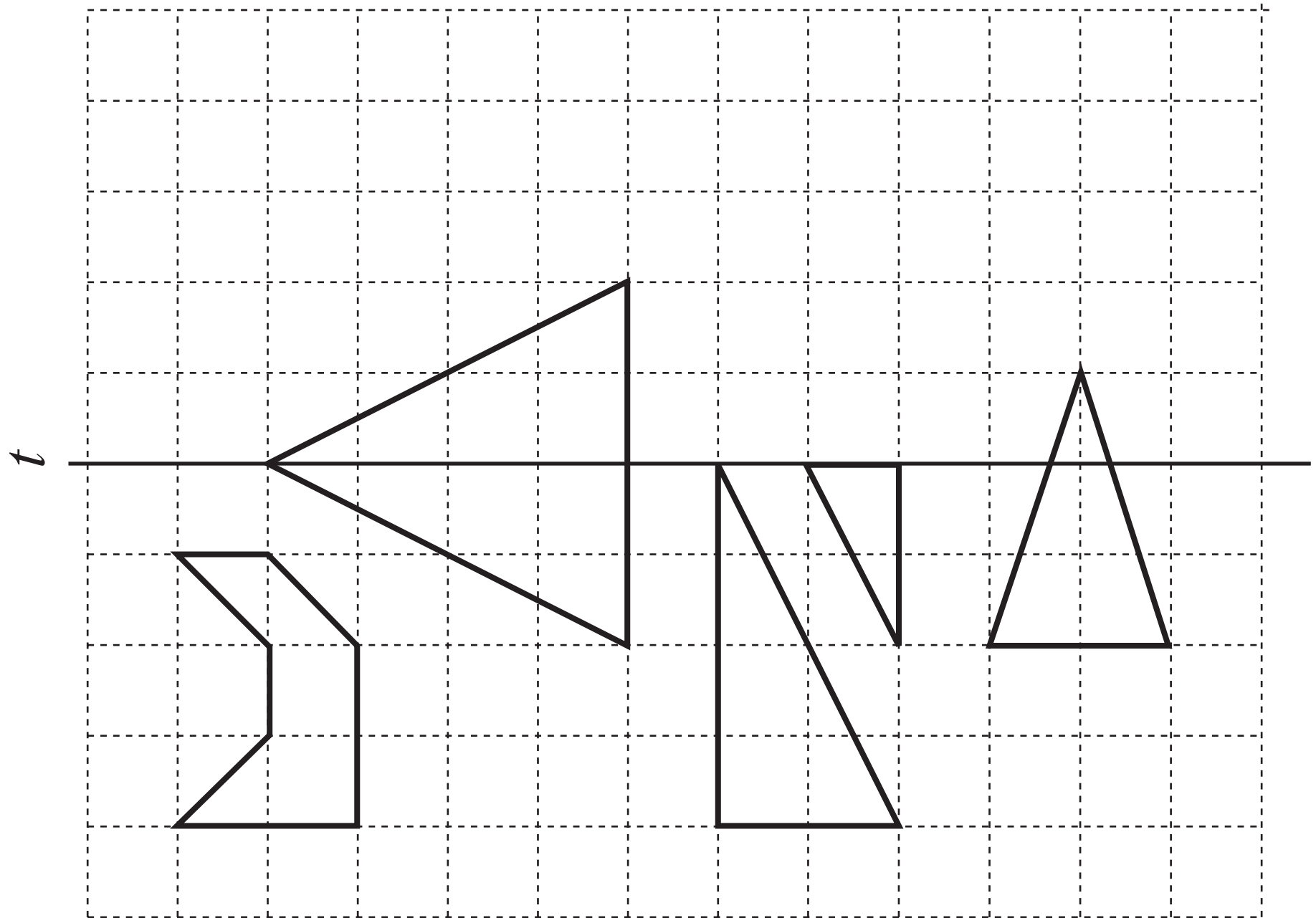

a)

b)

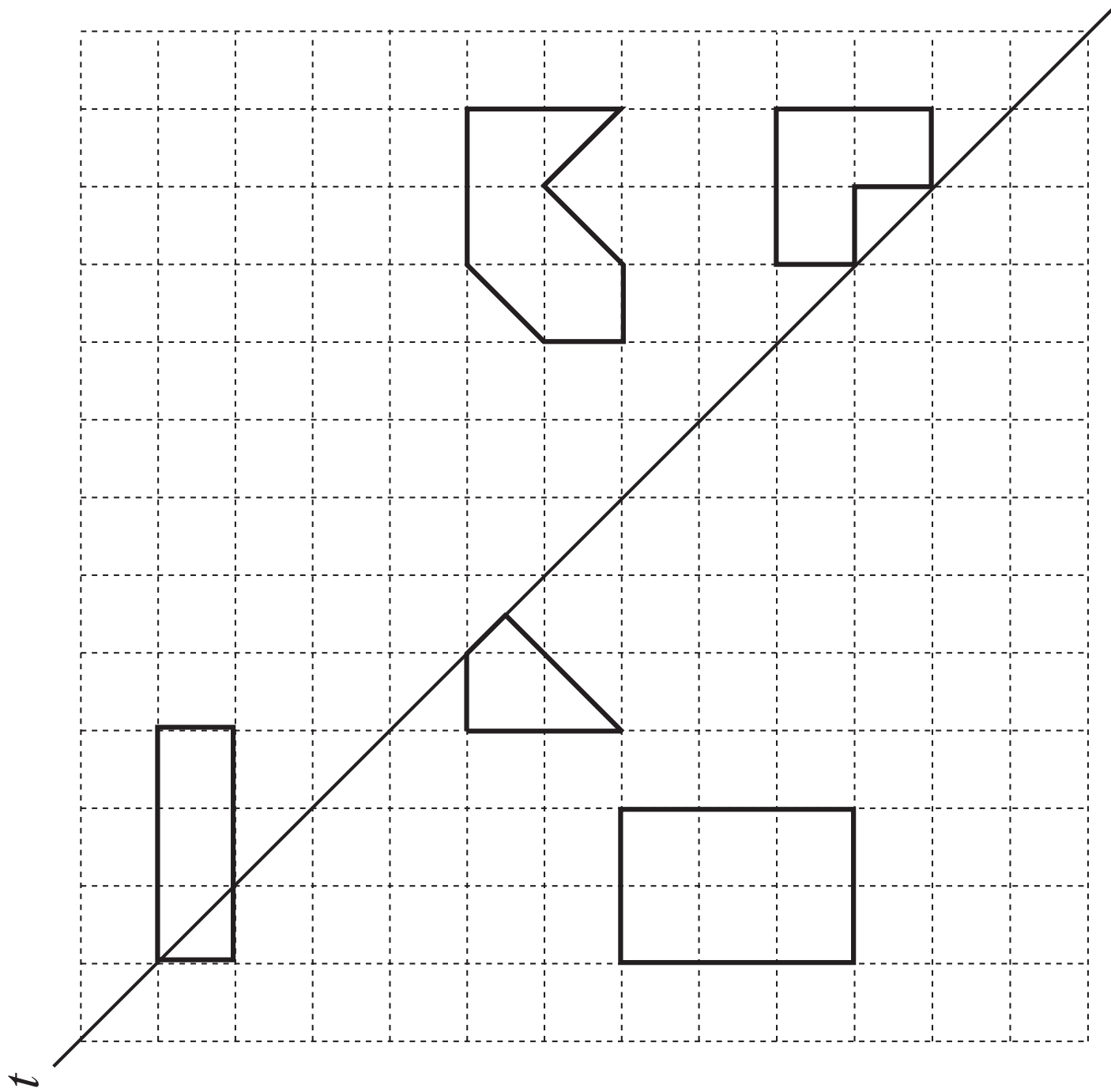

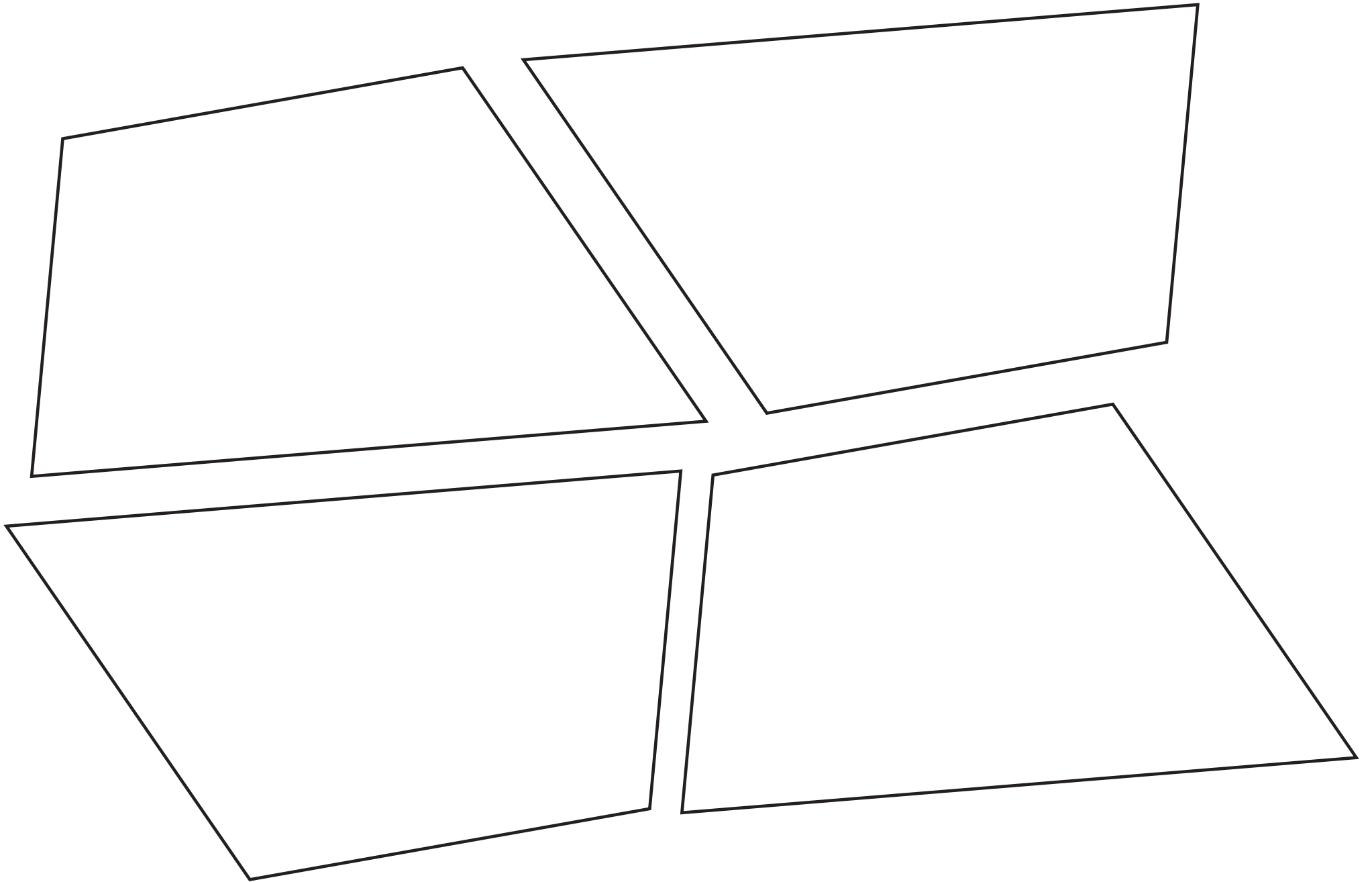

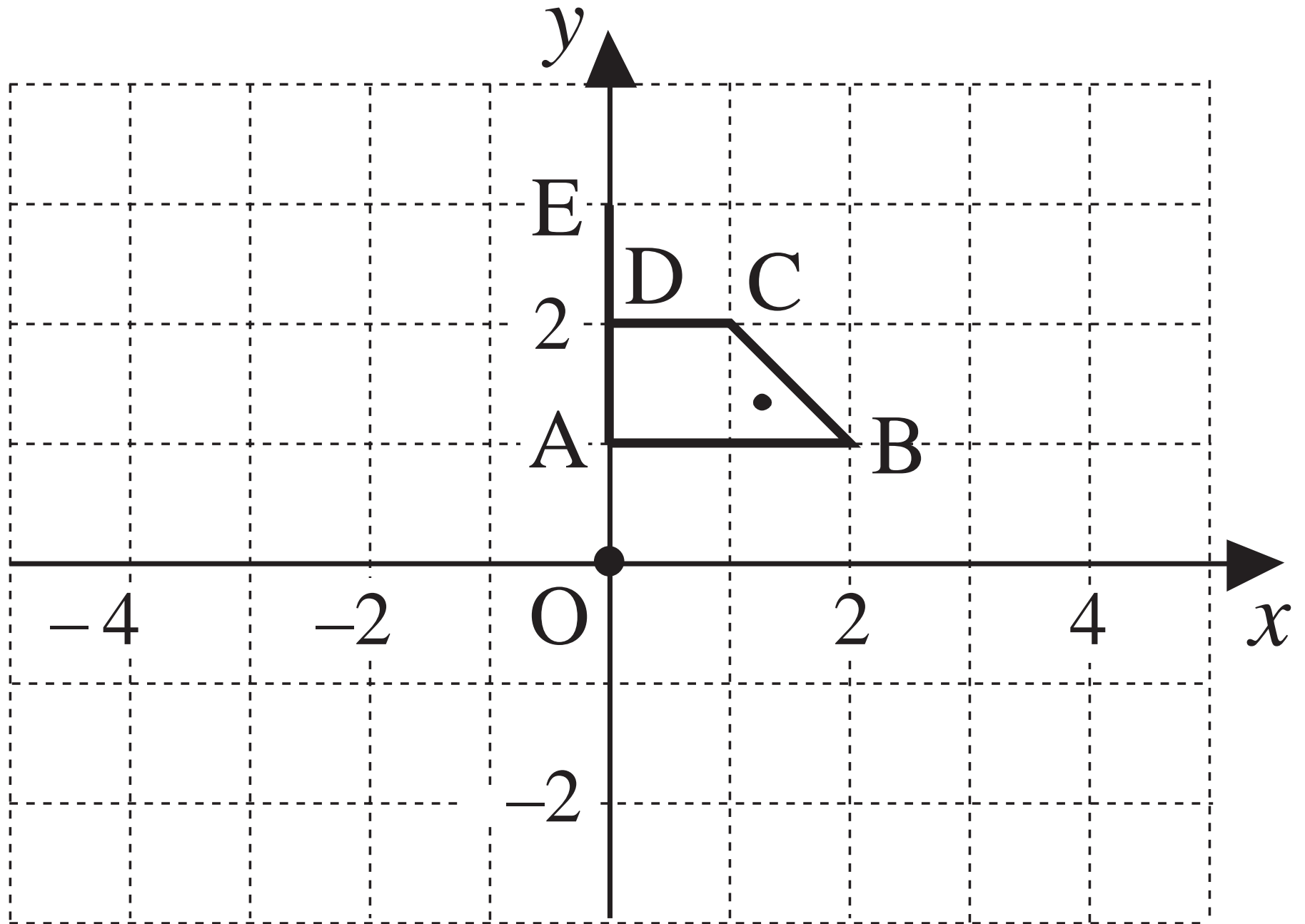

a)

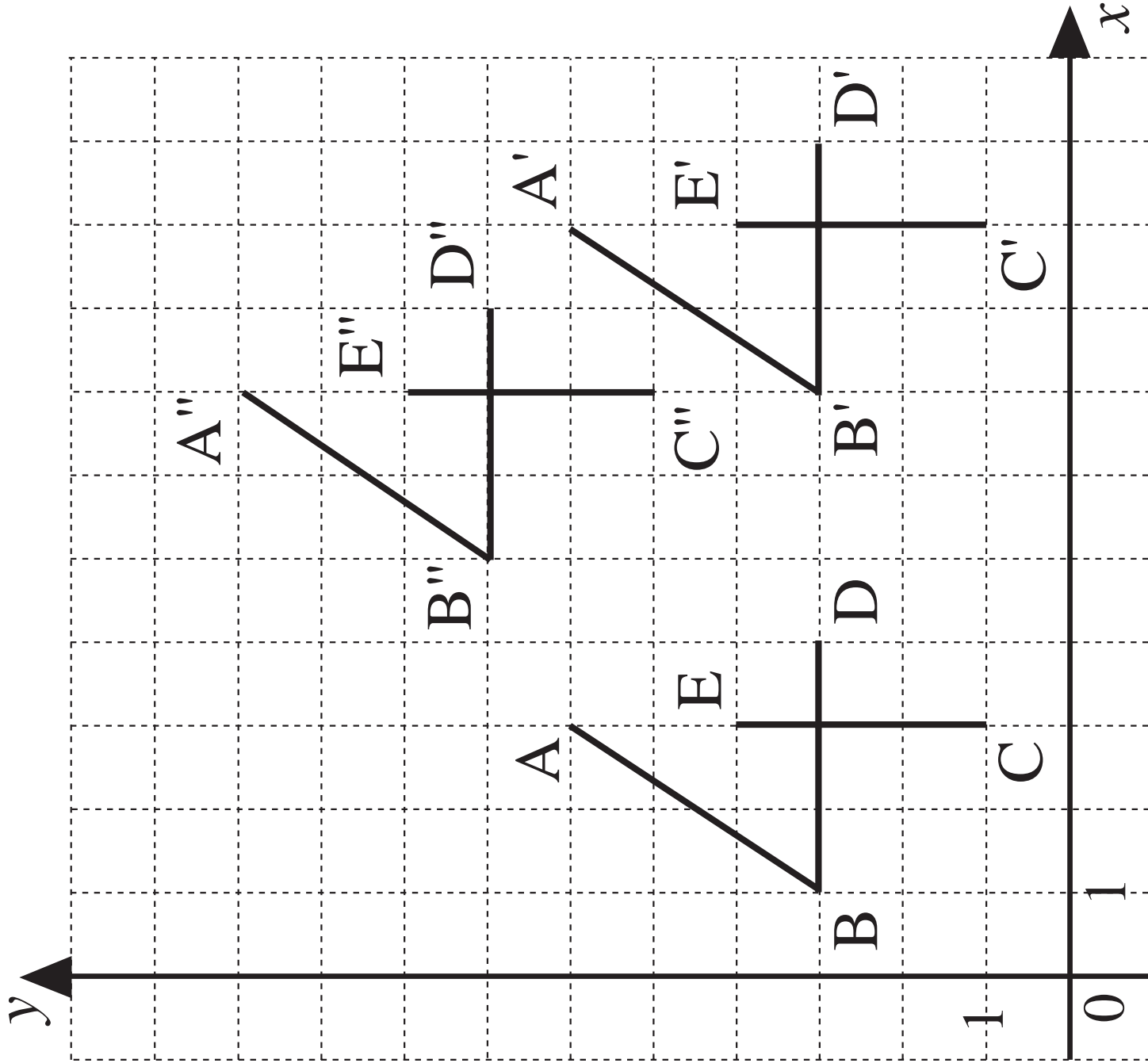

b)

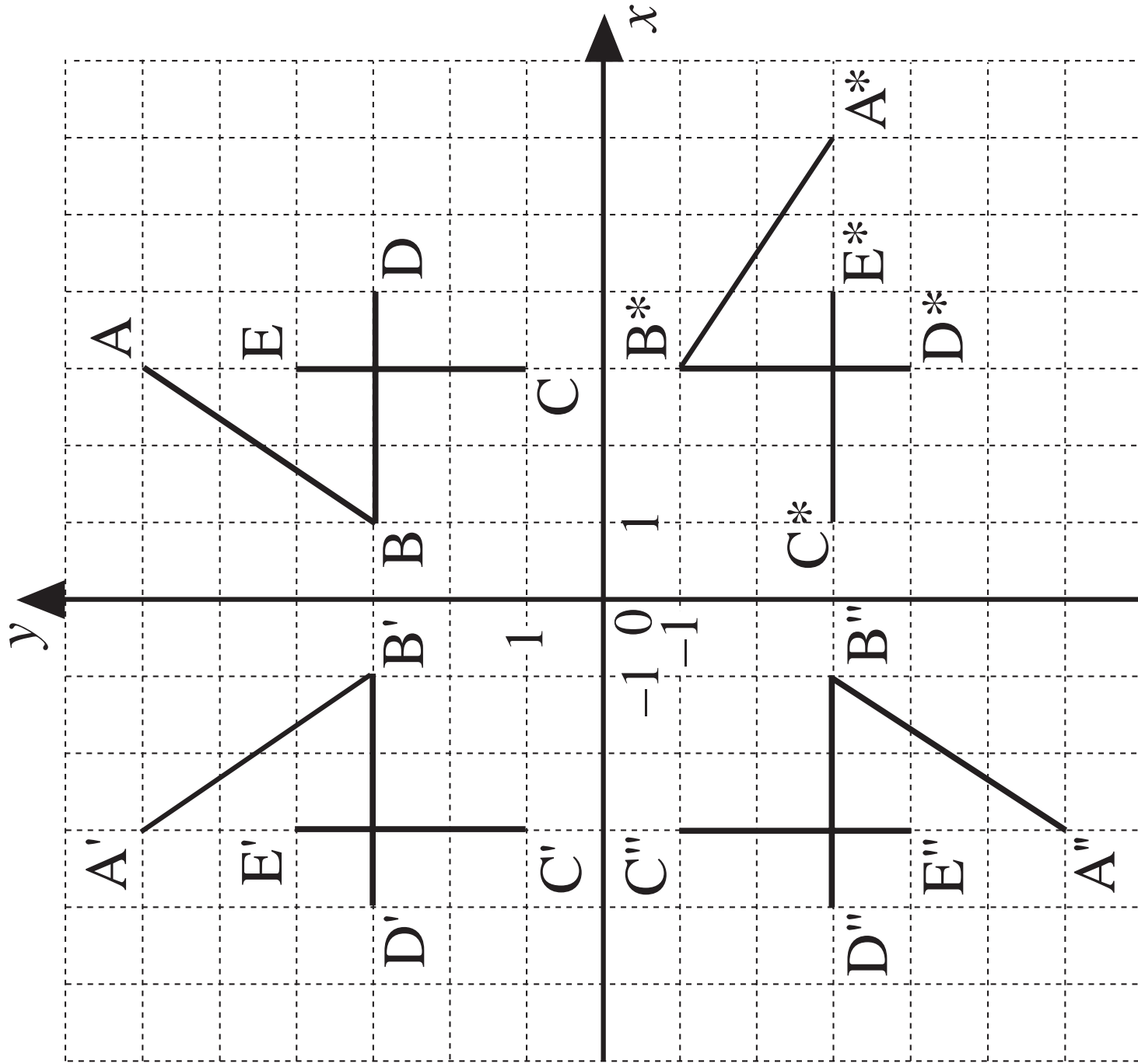

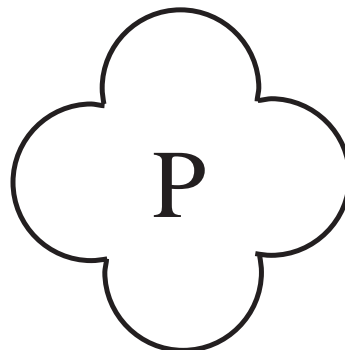
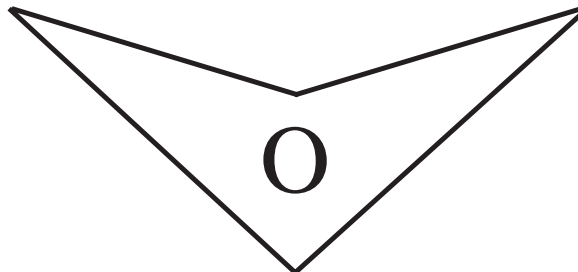
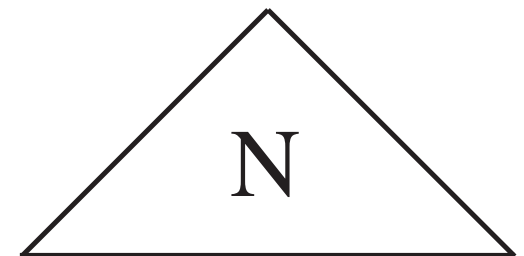
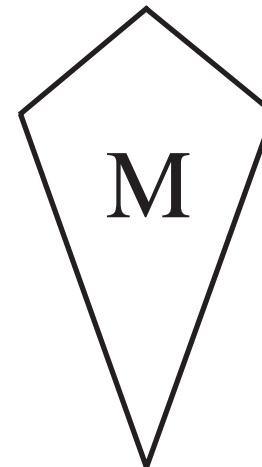
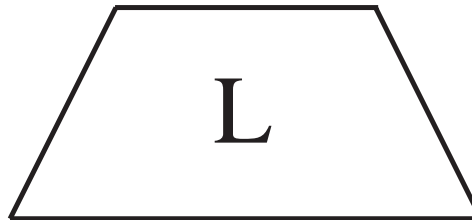
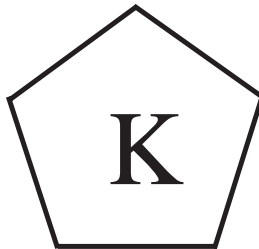
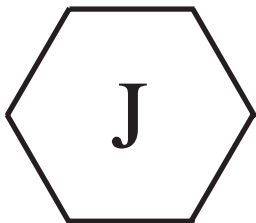
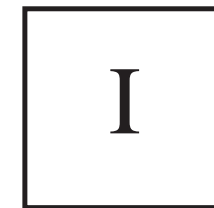
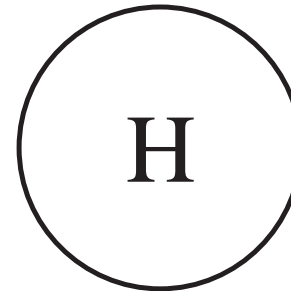
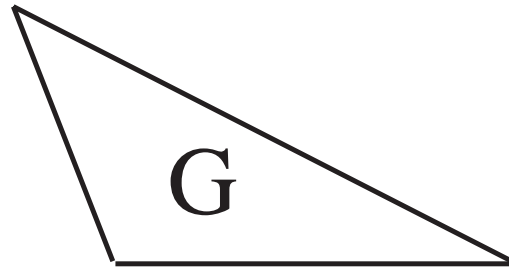
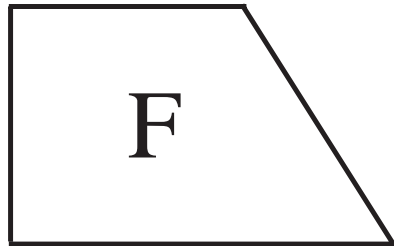
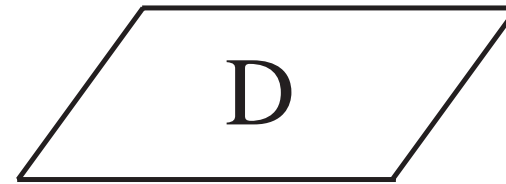
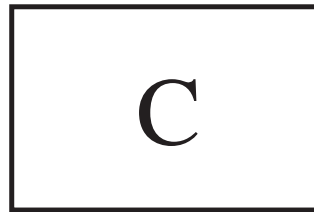
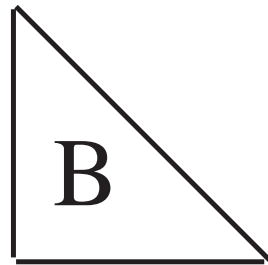
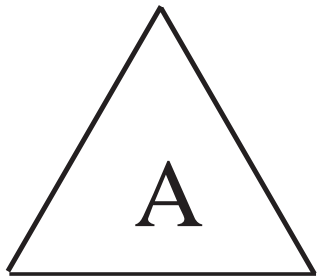

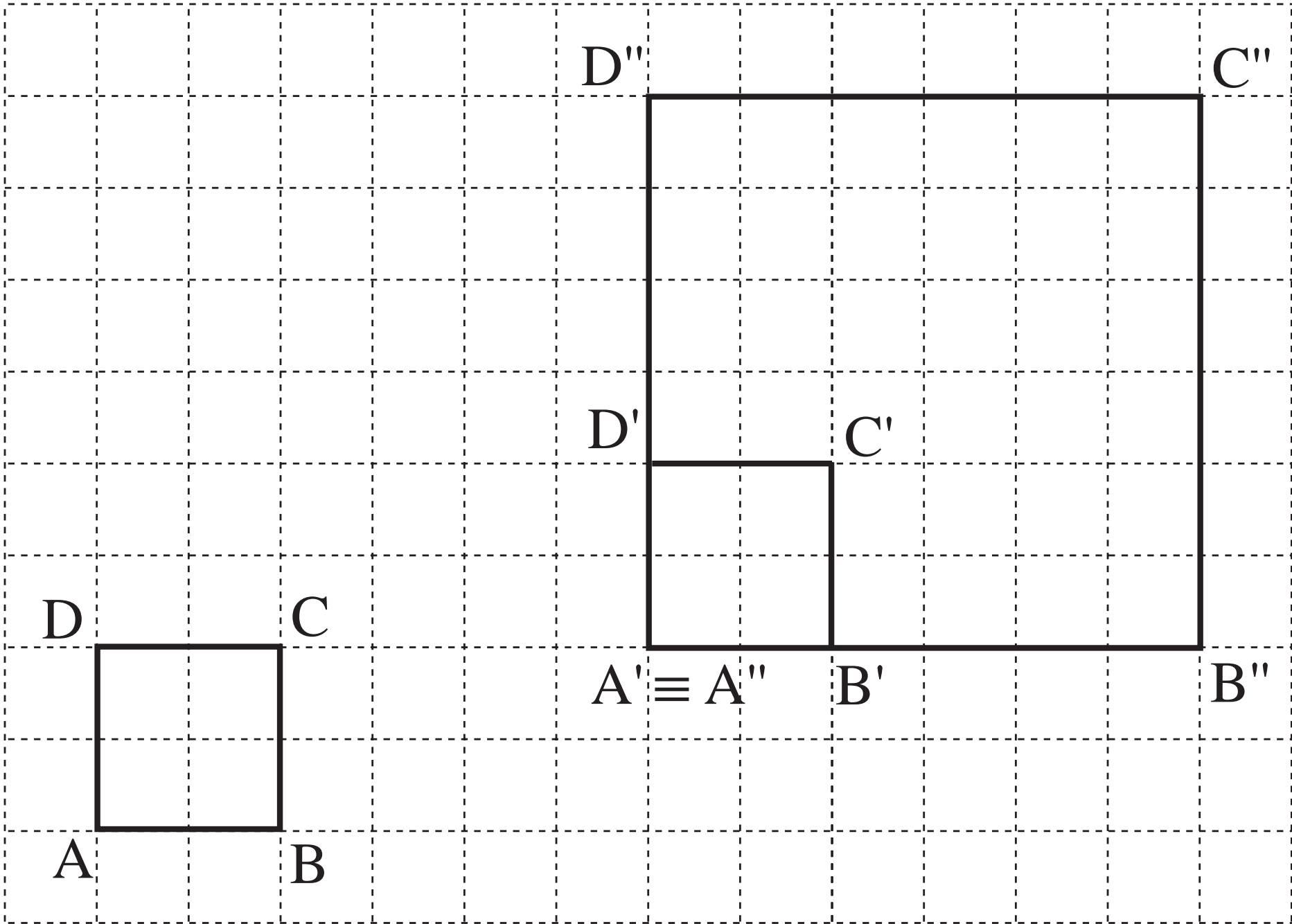

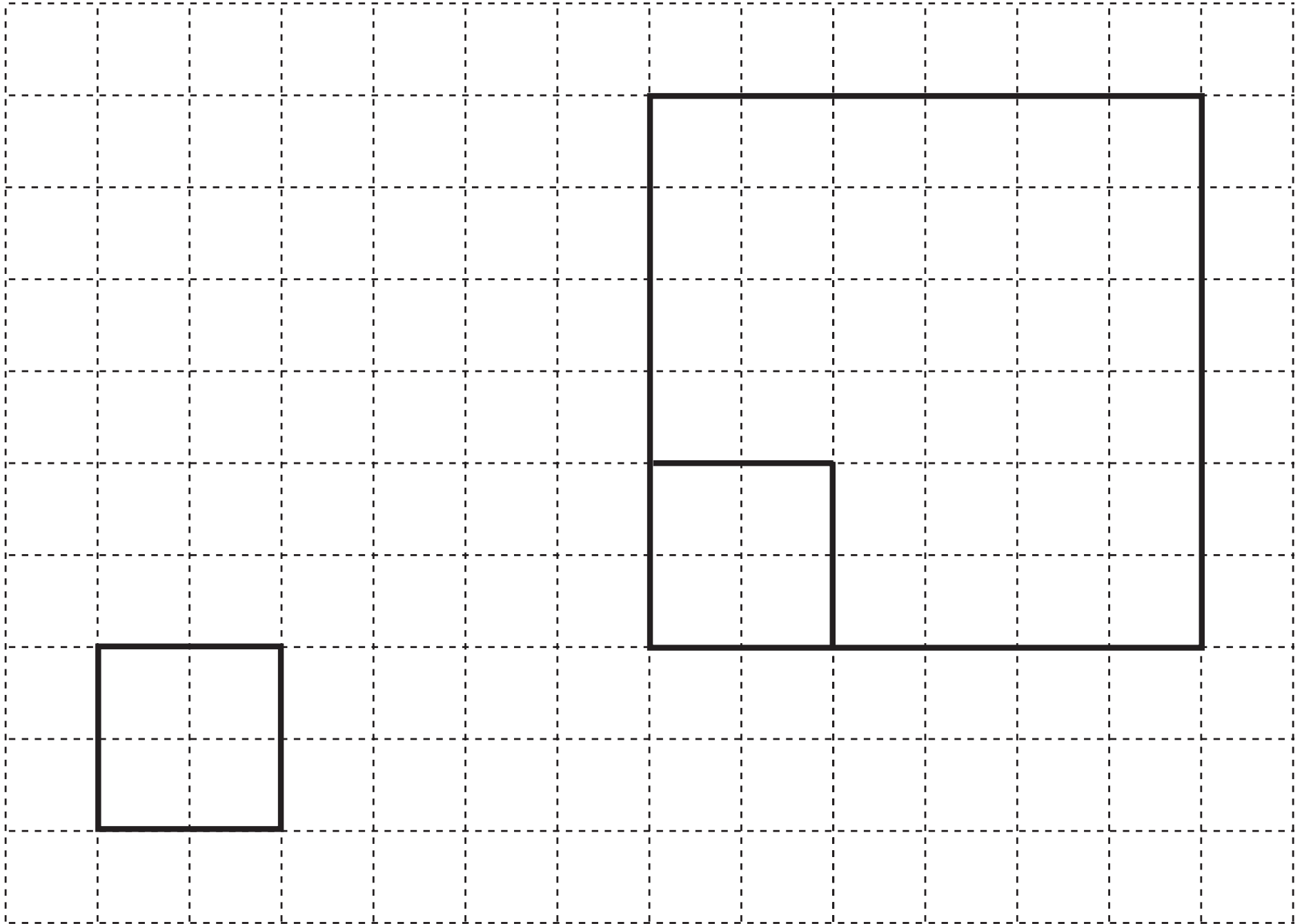

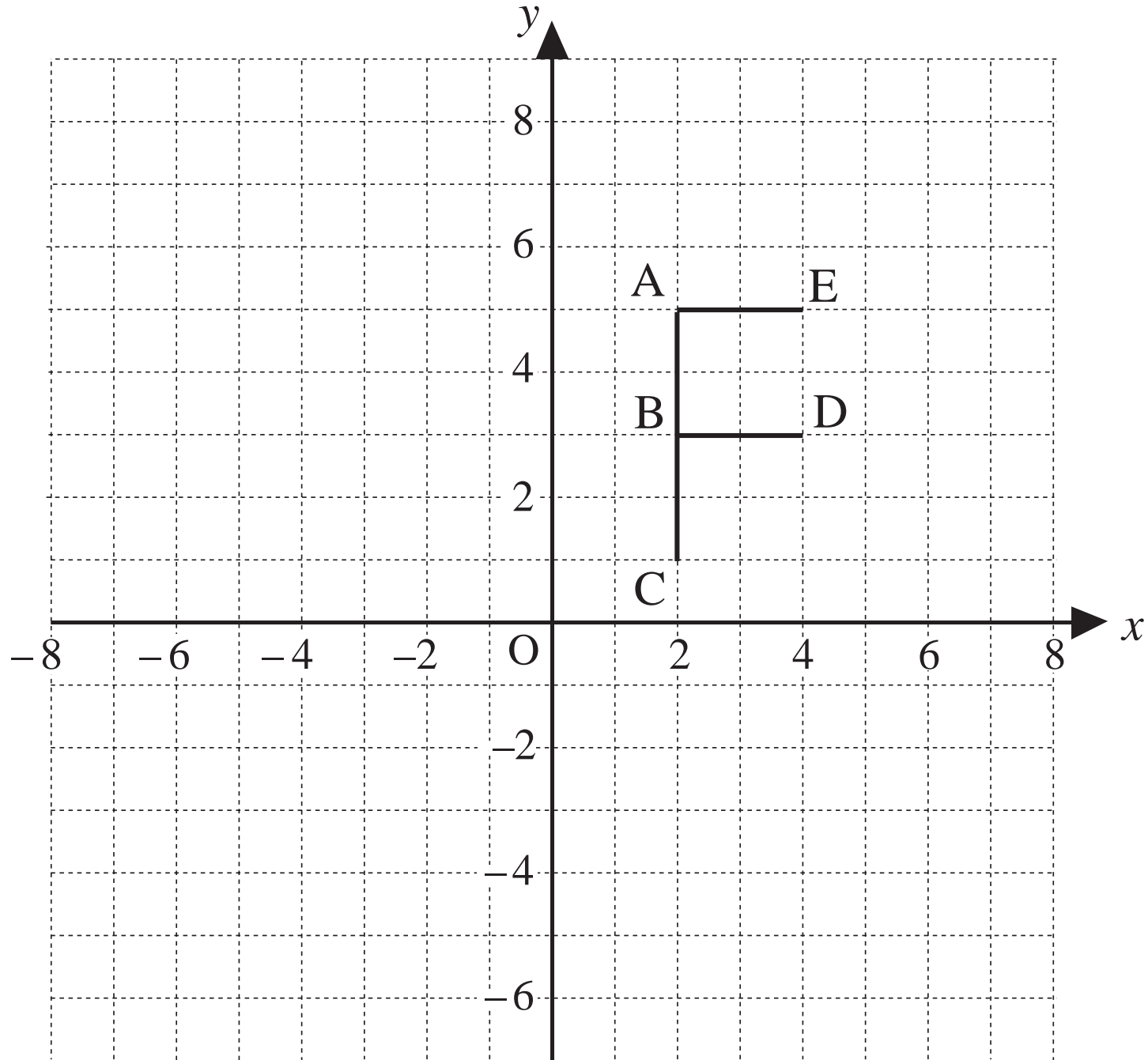

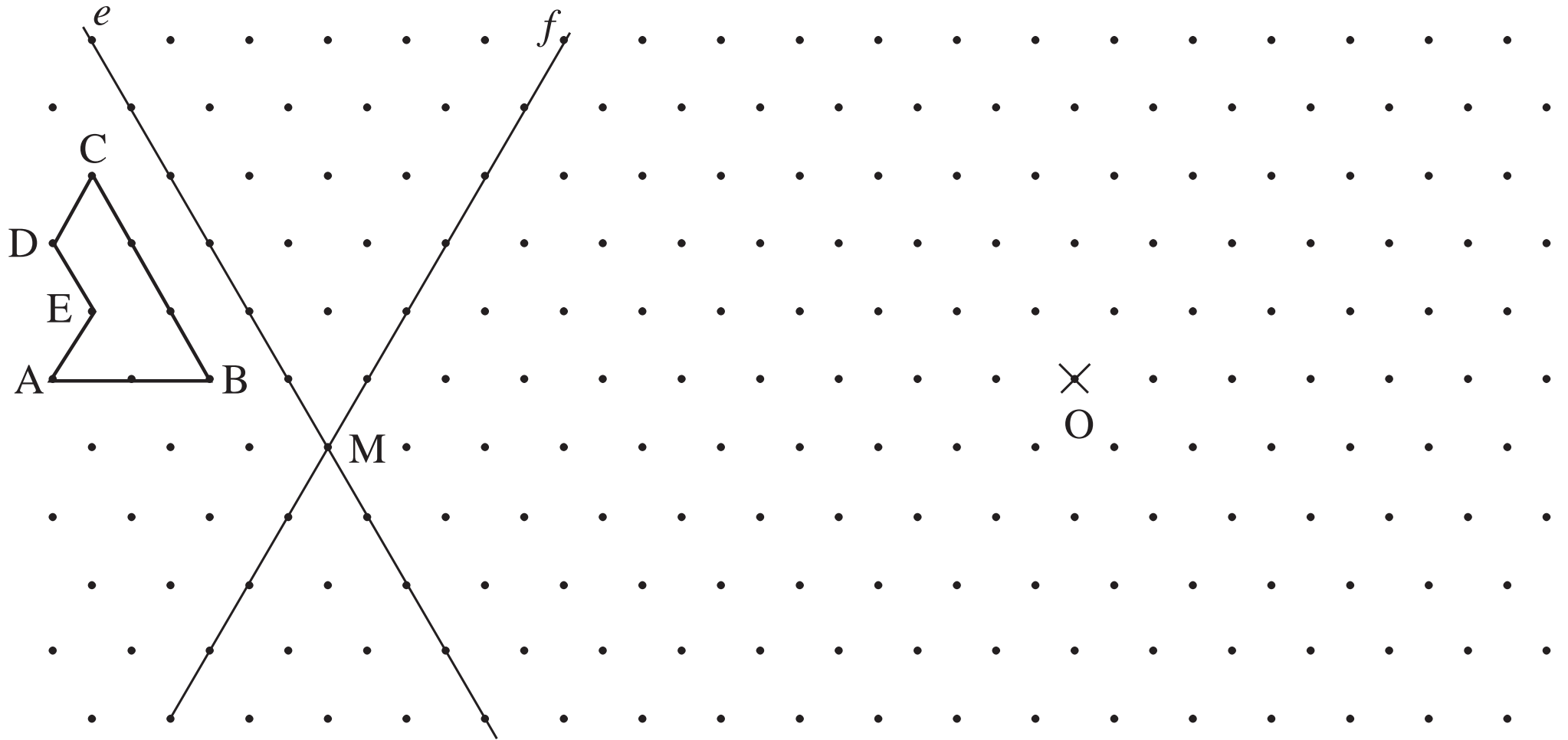

a)

i)

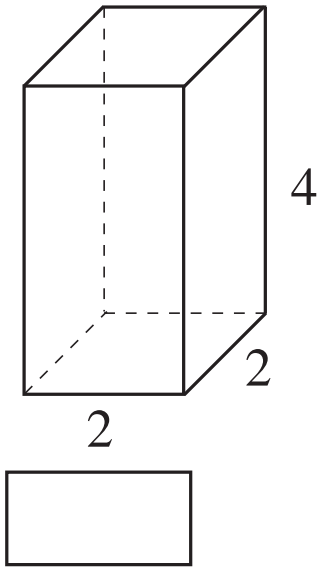

ii)

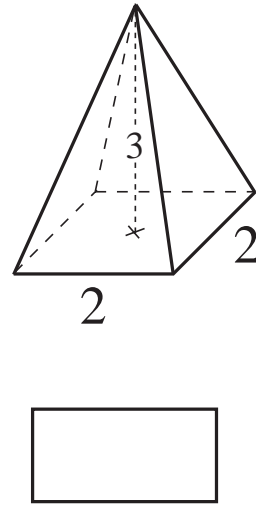

iii)

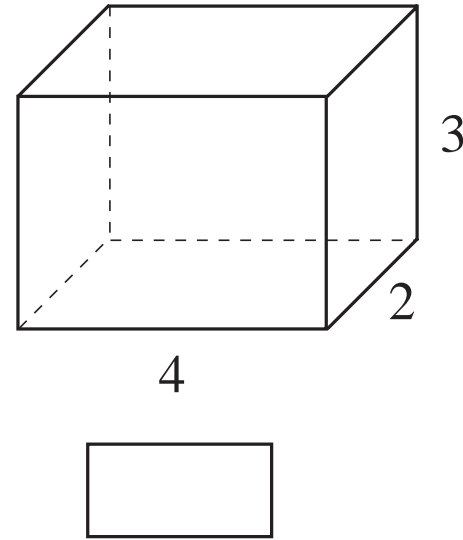

iv)

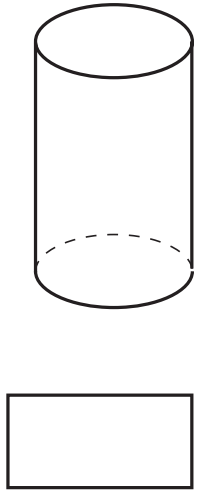

b)

i)

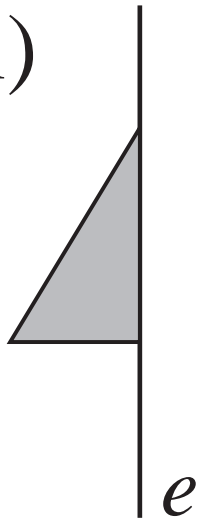

ii)

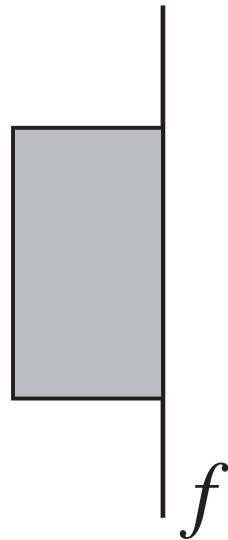

iii)

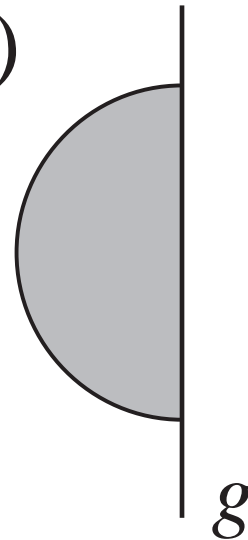

iv)

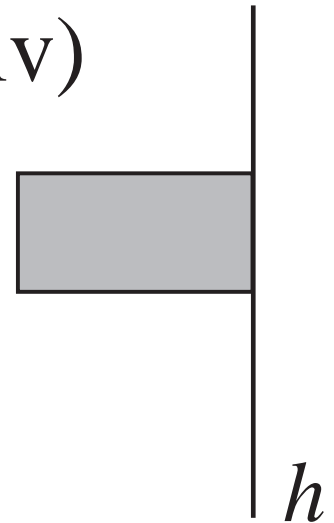

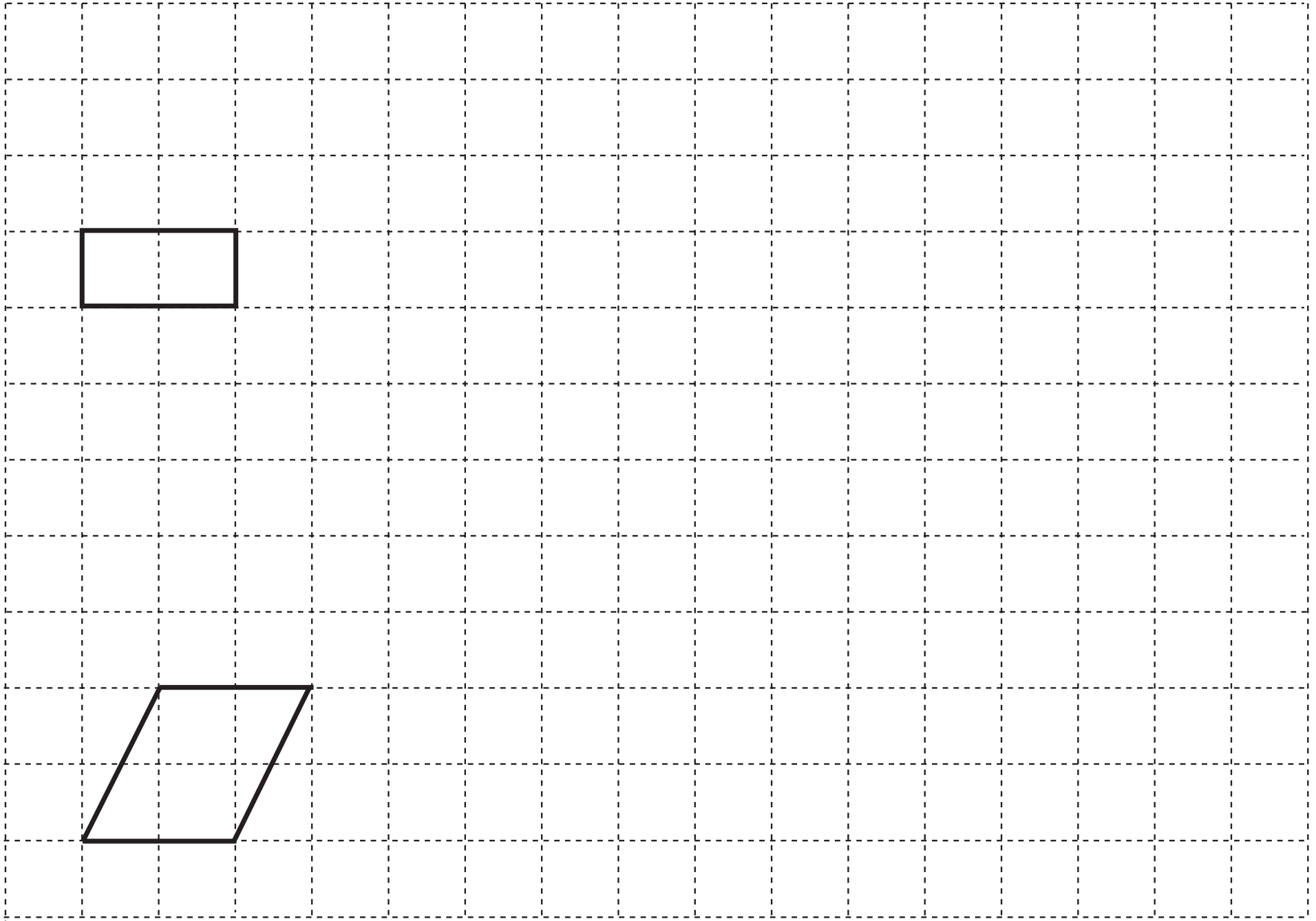

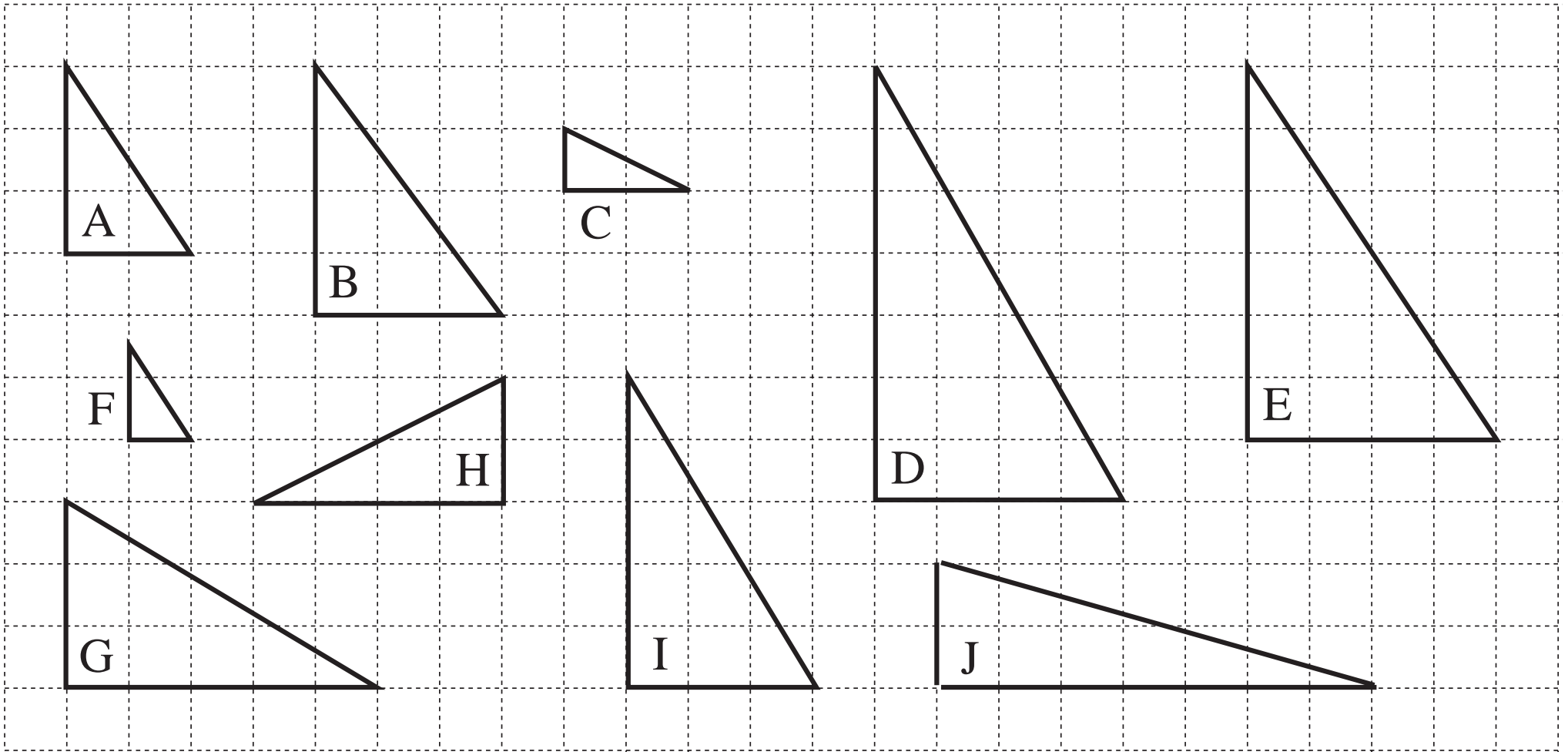

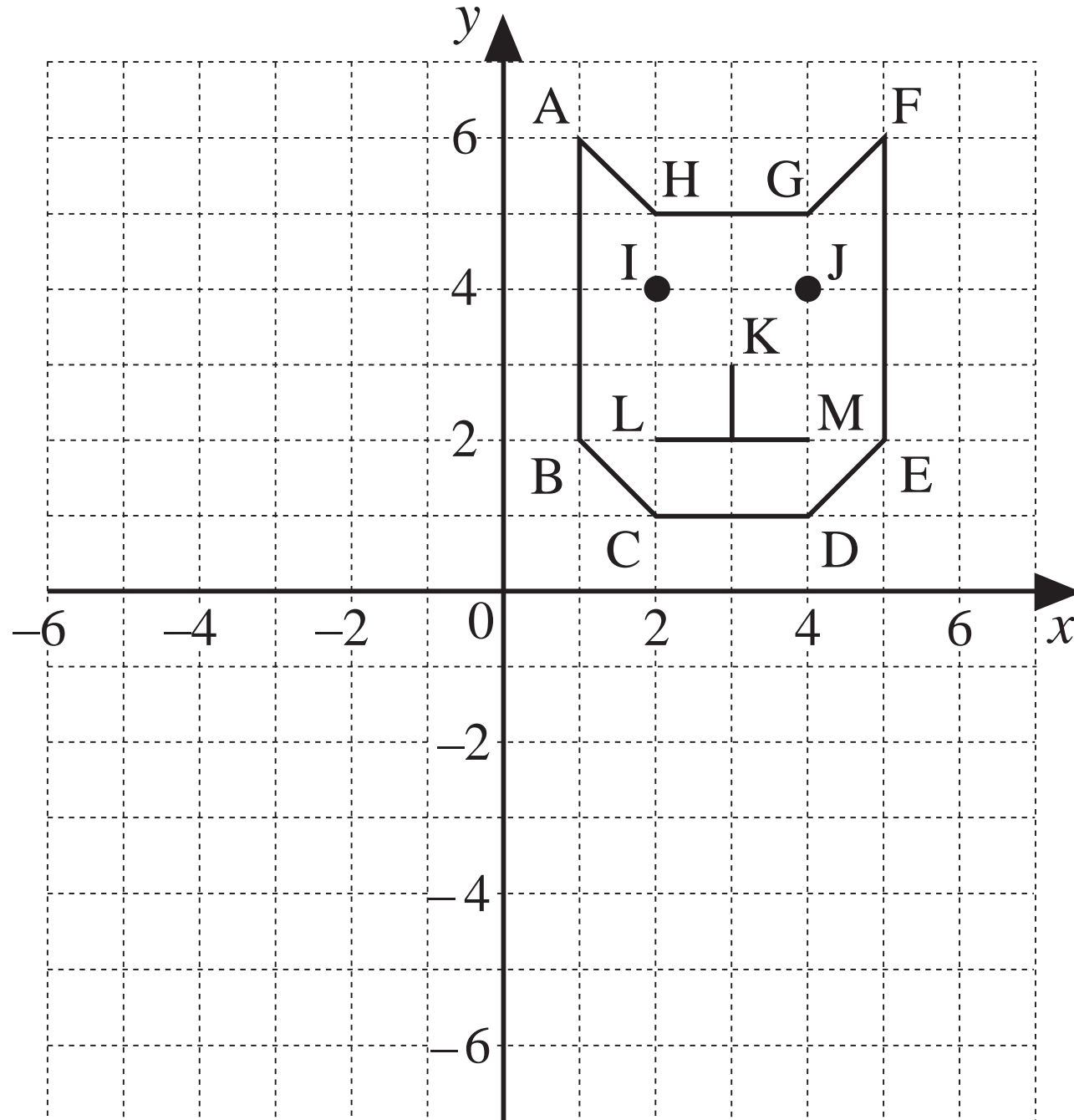

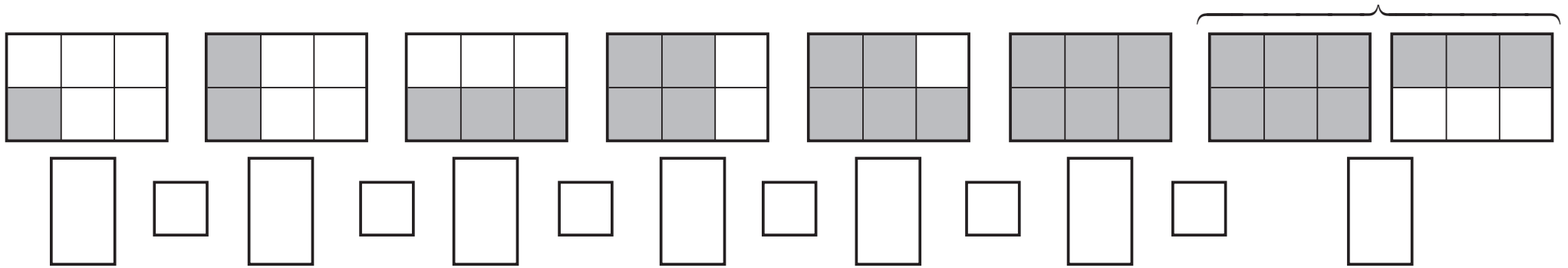

LP 96/2

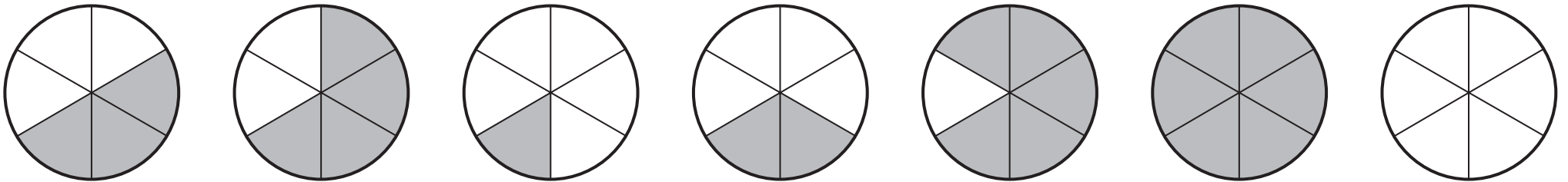

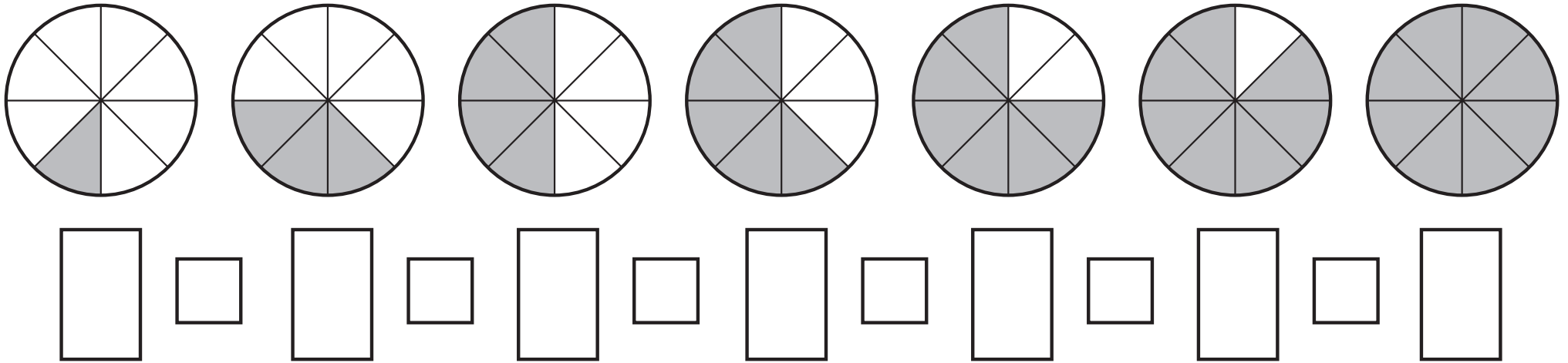

LP 96/5

$$\frac{3}{4}, \square; \quad -\frac{1}{2}, \square; \quad \frac{4}{4}, \square; \quad -\frac{5}{4}, \square$$

 0

LP 96/8



1

1

1

1

a)

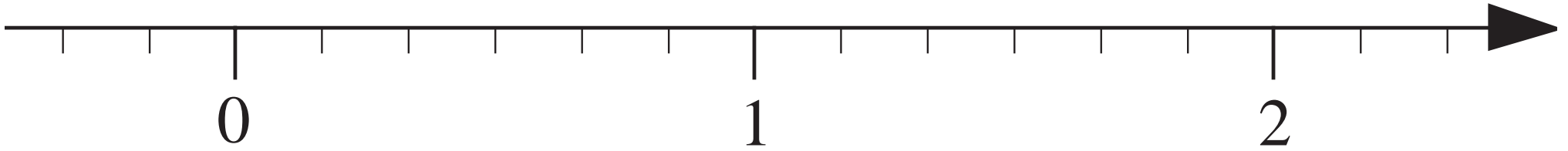

b)

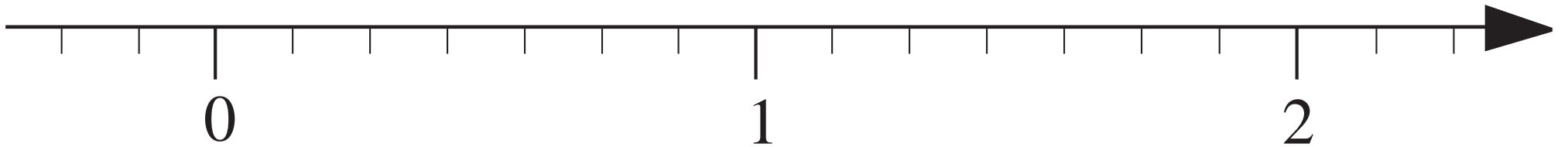

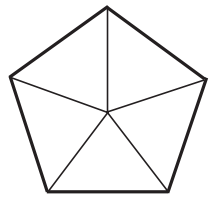
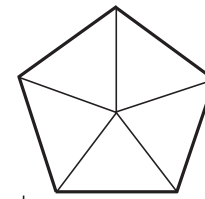
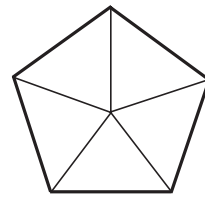
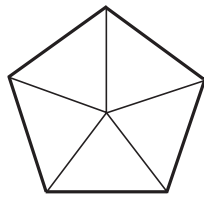
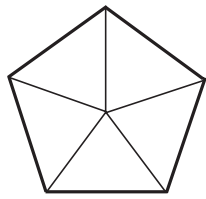
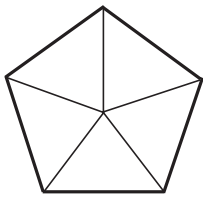
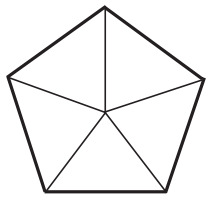
 $\frac{1}{5}$

 $\frac{2}{5}$

 $\frac{3}{5}$

 $\frac{4}{5}$

 $\frac{5}{5}$

 $\frac{7}{5}$

LP 97/5

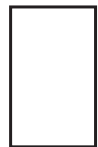
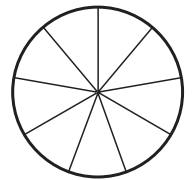
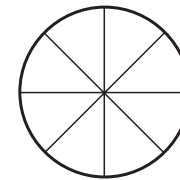
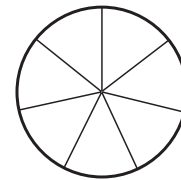
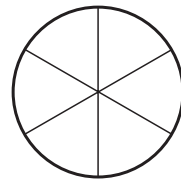
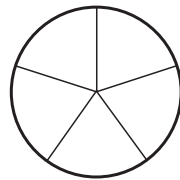
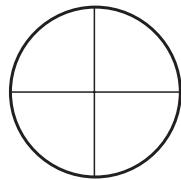
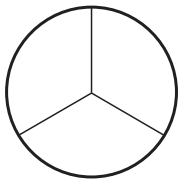
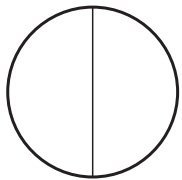

LP 97/6

$$\frac{3}{2}, -\frac{6}{6}, \frac{4}{3}, -\frac{5}{6}, \frac{1}{2}, -\frac{2}{3}$$

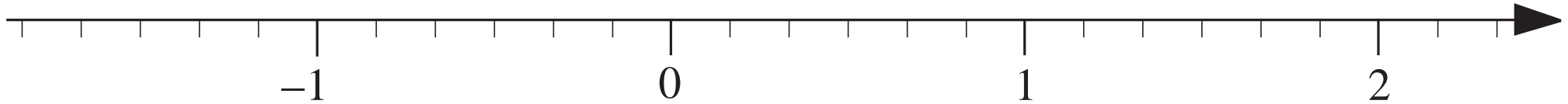

LP 97/7

a)

$\frac{1}{2} + \square = 1$	$\frac{1}{3} + \square = 1$	$\frac{2}{3} + \square = 1$	$\frac{3}{3} + \square = 1$
$\frac{3}{7} + \square = 1$	$\square + \frac{2}{9} = 1$	$\frac{4}{5} + \square = 1$	$\frac{4}{5} + \square = 2$

b)

$1 - \frac{2}{2} = \square$	$1 - \frac{1}{2} = \square$	$1 - \frac{0}{2} = \square$	$1 - \frac{3}{4} = \square$
$2 - \frac{4}{5} = \square$	$1 - \frac{3}{7} = \square$	$2 - \frac{6}{6} = \square$	$3 - \frac{2}{5} = \square$

LP 97/8



1

1										

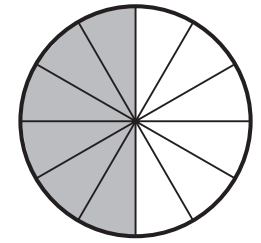
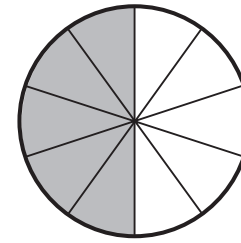
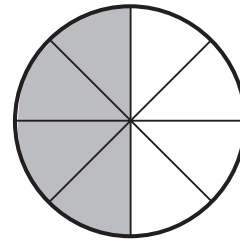
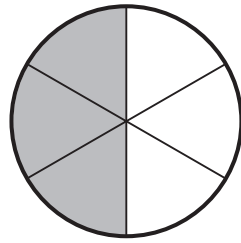
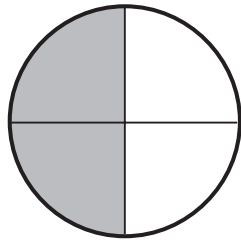
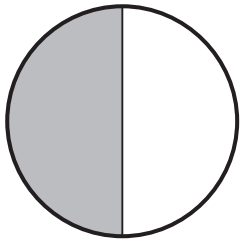

LP 98/2

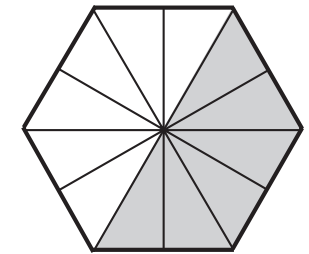
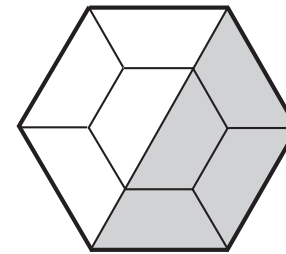
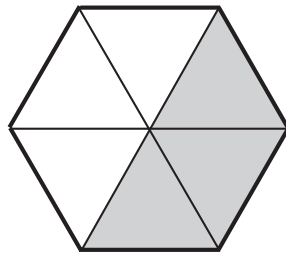
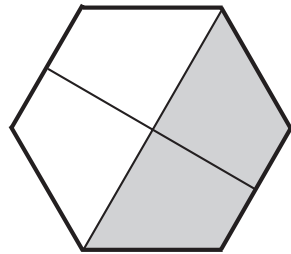
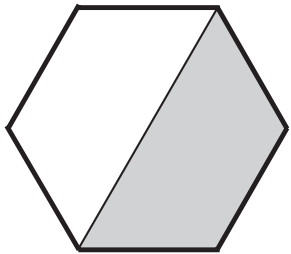

LP 98/6

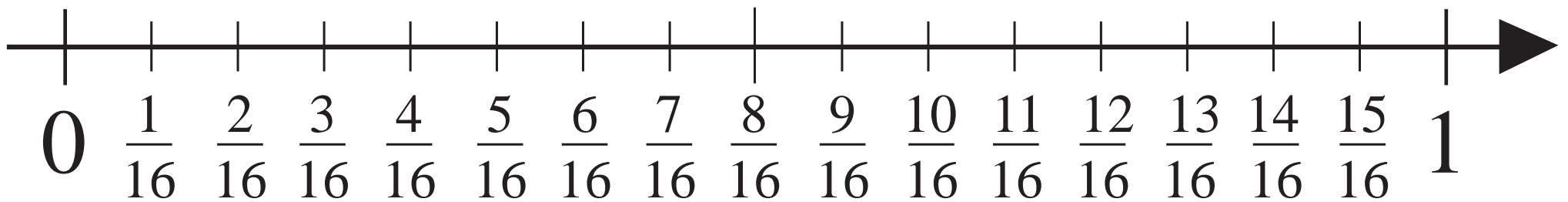
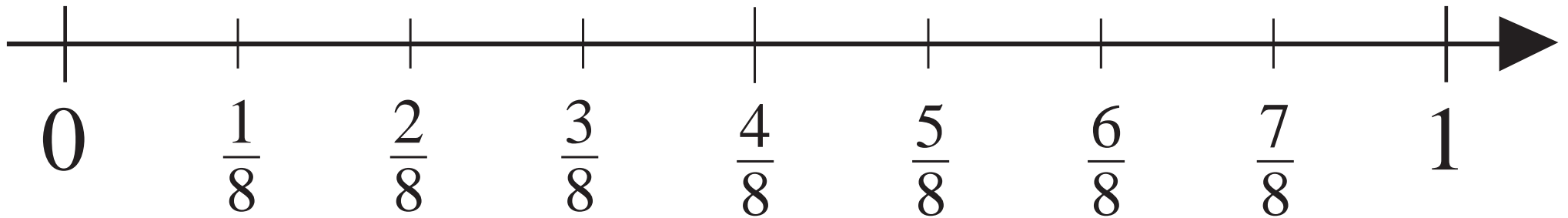
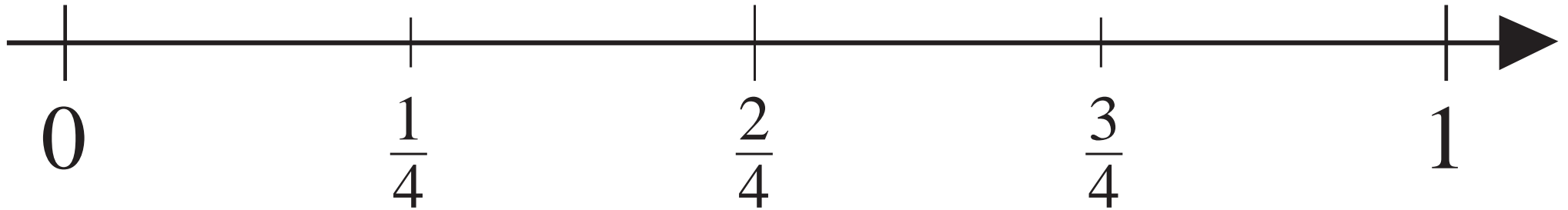

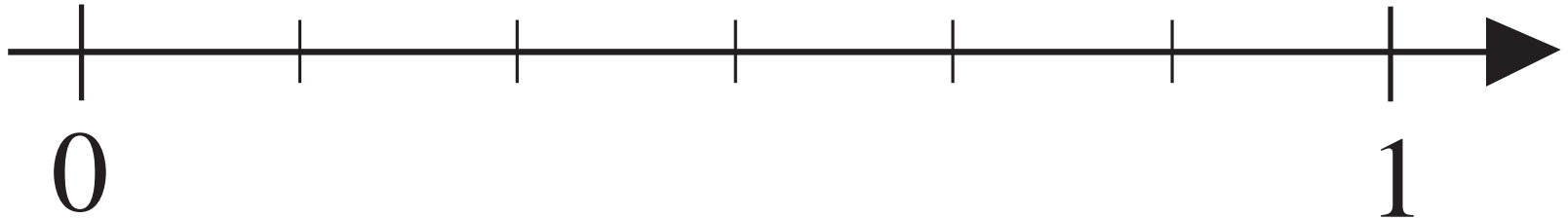
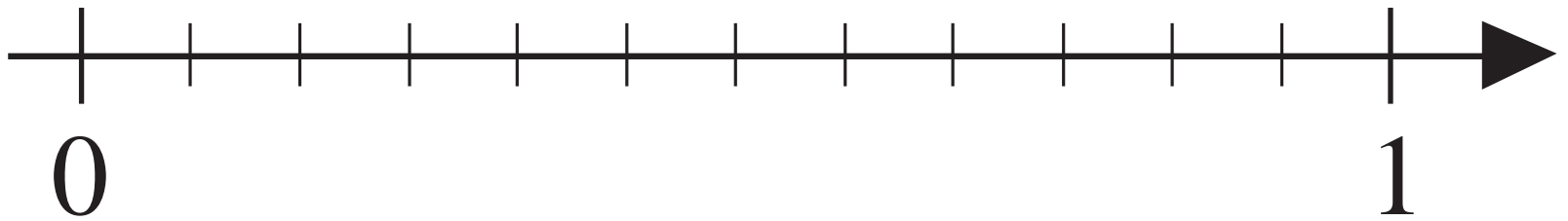
$\frac{1}{3}$  $\frac{1}{6}$  $\frac{5}{12}$ 

1																			
$\frac{1}{2}$																			
$\frac{1}{4}$																			
$\frac{1}{5}$																			
$\frac{1}{10}$																			
$\frac{1}{20}$																			

$$1 = \frac{2}{2} = \frac{4}{4} = \frac{5}{5} = \frac{10}{10} = \frac{20}{20}$$

$$\frac{1}{2} =$$

$$\frac{1}{4} =$$

$$\frac{3}{4} =$$

$$\frac{1}{5} =$$

$$\frac{2}{5} =$$

$$\frac{3}{5} =$$

$$\frac{4}{5} =$$

$$\frac{1}{10} =$$

$$\frac{3}{10} =$$

$$\frac{7}{10} =$$

$$\frac{9}{10} =$$

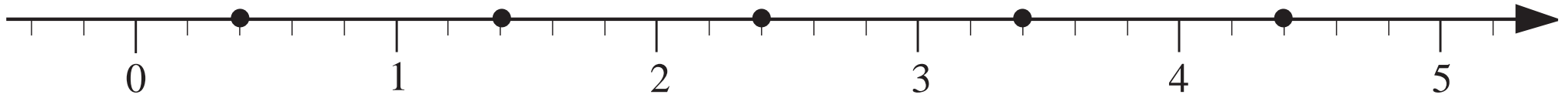

LP 99/2

a) $\frac{2}{3} \square \frac{5}{6}$

b) $\frac{3}{5} \square \frac{11}{20}$

c) $\frac{6}{10} \square \frac{2}{5}$

d) $\frac{3}{8} \square \frac{1}{3}$

e) $\frac{5}{8} \square \frac{5}{6}$

f) $-\frac{7}{10} \square \frac{3}{10}$

g) $-\frac{7}{10} \square -\frac{3}{10}$

h) $-\frac{3}{4} \square -\frac{1}{2}$

LP 99/3

a) $\frac{3}{4} = \frac{6}{8} = \frac{\square}{12} = \frac{\square}{16} = \frac{15}{\square} = \frac{\square}{\square} =$

b) $\frac{6}{5} = \frac{12}{\square} = \frac{\square}{20} = \frac{18}{\square} = 1 + \frac{\square}{5} = 1 \frac{\square}{5}$

c) $\frac{12}{3} = \frac{24}{\square} = \frac{\square}{9} = \frac{\square}{1} = \frac{4}{\square} = \frac{\square}{12} =$

a) $\frac{3}{4} \square \frac{5}{8}$

b) $\frac{4}{5} \square \frac{8}{10}$

c) $\frac{7}{9} \square \frac{2}{3}$

d) $\frac{23}{50} \square \frac{4}{10}$

e) $\frac{2}{3} \square \frac{5}{8}$

f) $\frac{1}{4} \square \frac{1}{5}$

g) $\frac{5}{6} \square \frac{7}{9}$

h) $\frac{40}{30} \square \frac{25}{20}$

LP 99/5

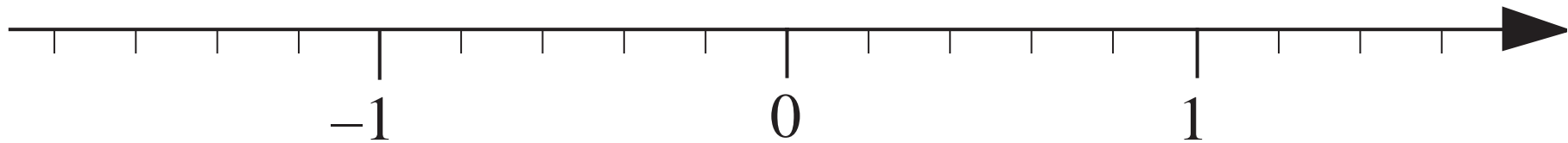
 $\frac{3}{5}, -\frac{1}{5}, \frac{6}{5}, \frac{4}{10}, -\frac{6}{10}, \frac{4}{5}$ 

LP 100/3

a)

1

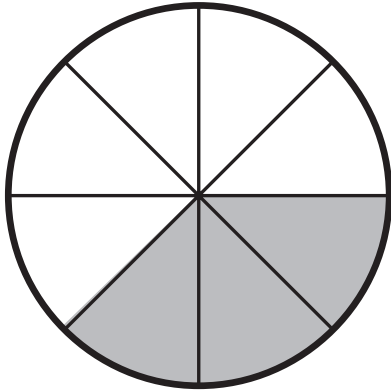

b)

1

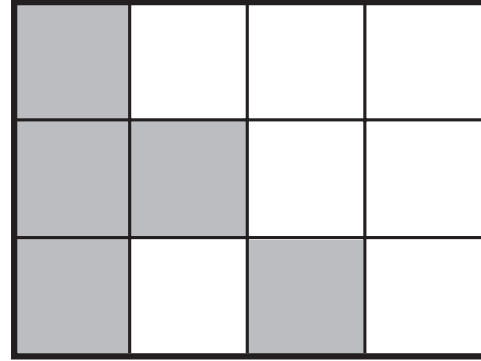

c)

1

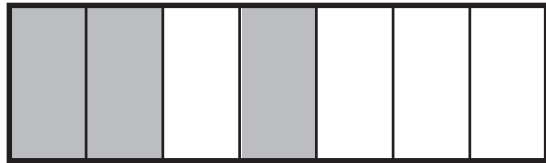

d)

1

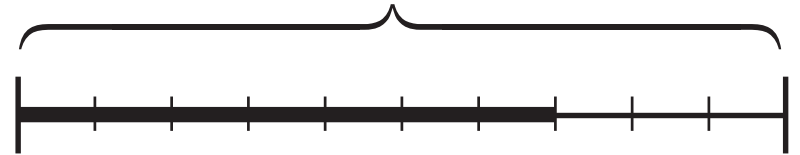

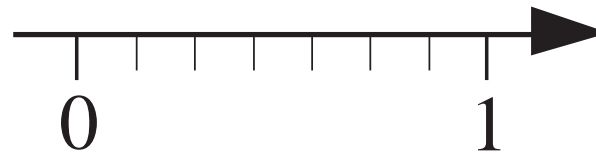
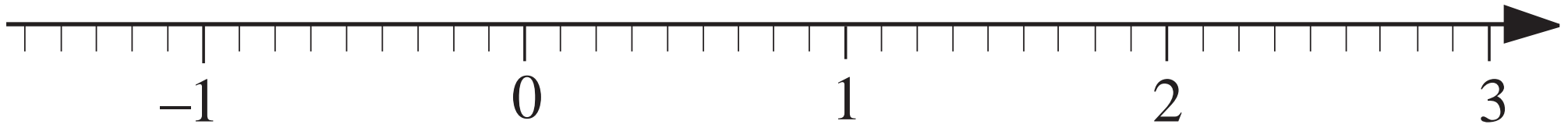

LP 102/1

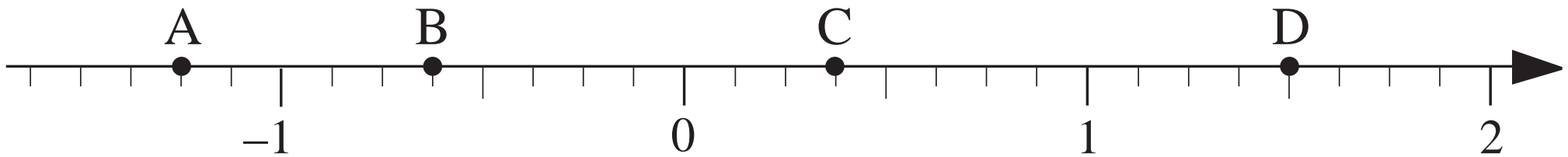

LP 102/6

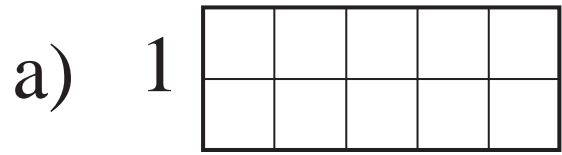

i) $\frac{3}{5} + \frac{2}{10} =$

ii) $\frac{3}{5} - \frac{2}{10} =$

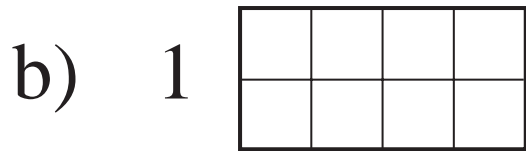

i) $\frac{3}{8} + \frac{1}{4} =$

ii) $\frac{5}{8} - \frac{1}{2} =$

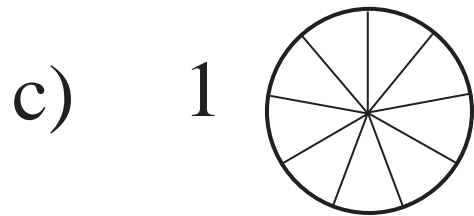

i) $\frac{2}{9} + \frac{2}{3} =$

ii) $\frac{8}{9} - \frac{2}{3} =$

iii) $\frac{1}{2} + \frac{4}{10} - \frac{3}{5} =$

iii) $\frac{3}{8} + \frac{1}{2} - \frac{1}{4} =$

iii) $\frac{1}{9} + \frac{2}{3} - \frac{4}{9} =$

$$\frac{3}{4} \square, \quad -\frac{1}{2} \square, \quad -\frac{1}{4} \square, \quad \frac{3}{8}, \quad \frac{2}{4} \square, \quad -\frac{5}{8}, \quad \frac{1}{2} \square$$

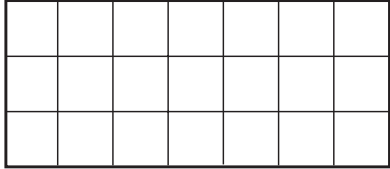
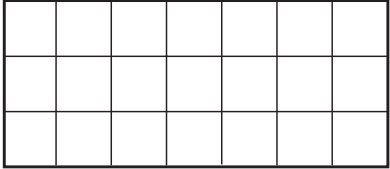

a)  1  1 $\frac{2}{3} + \frac{5}{7} =$

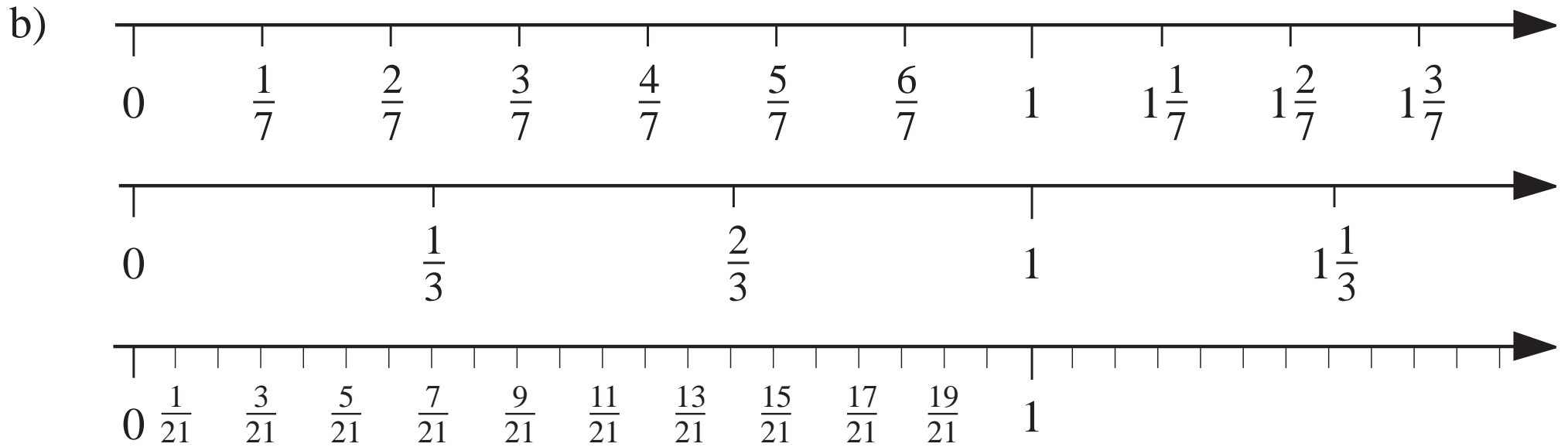

c) $\frac{2}{3} = \frac{4}{6} = \frac{6}{9} =$ $\frac{2}{3} + \frac{5}{7} =$
 $\frac{5}{7} = \frac{10}{14} =$

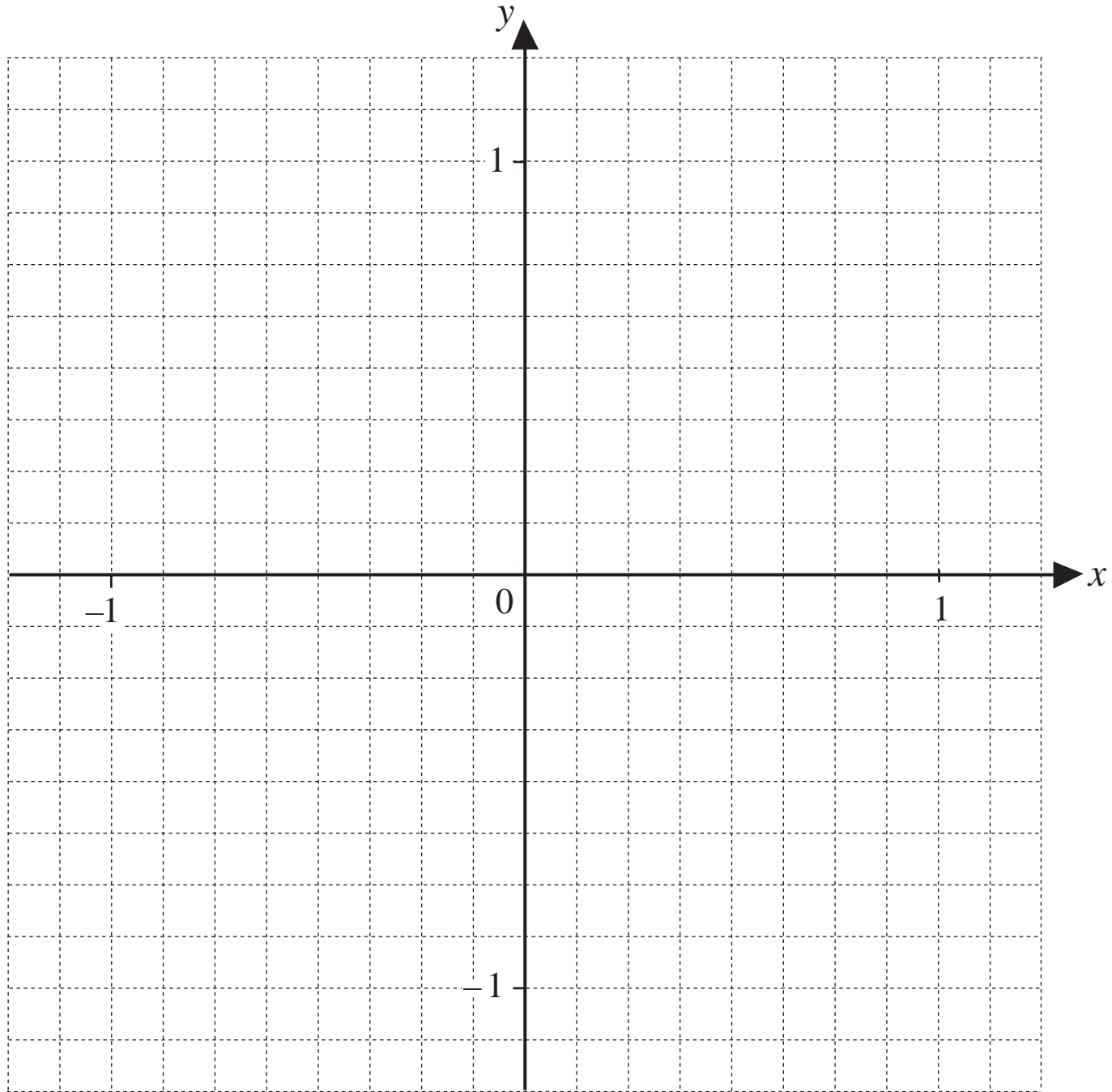

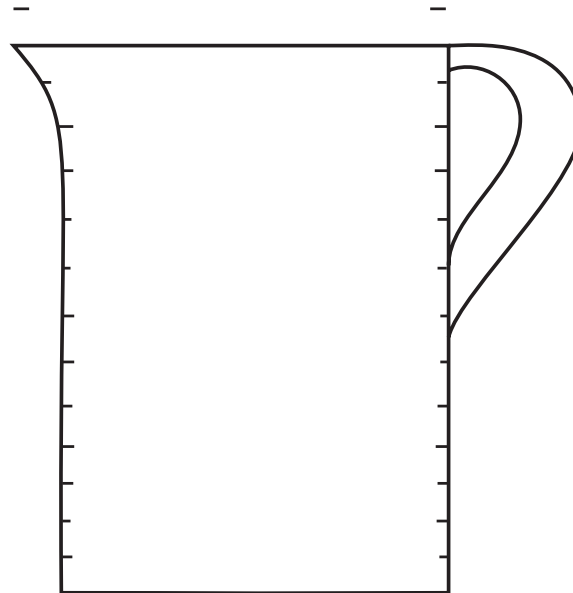
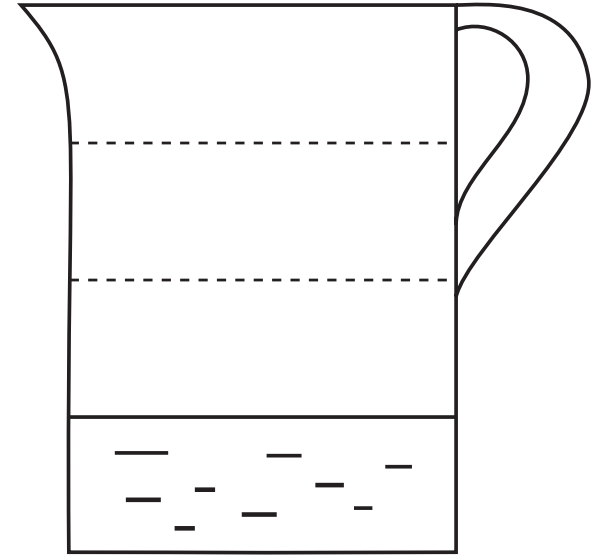
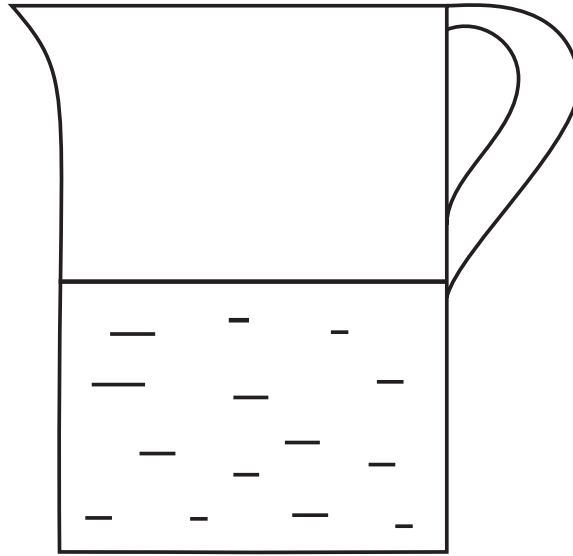
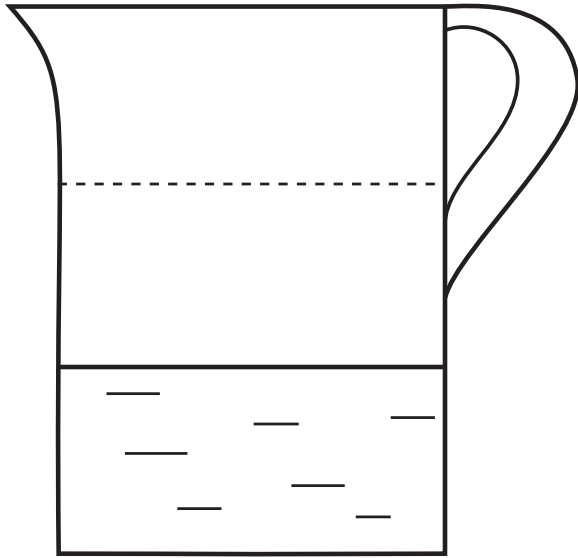

i)

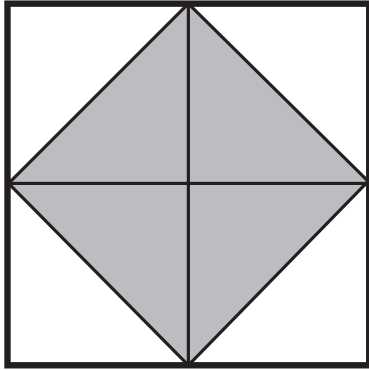

ii)

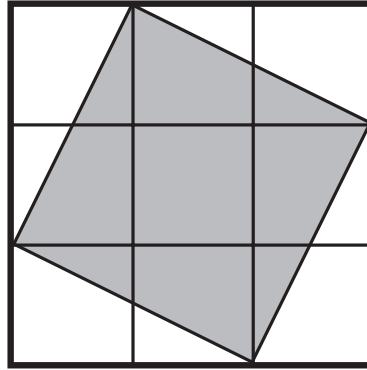

iii)

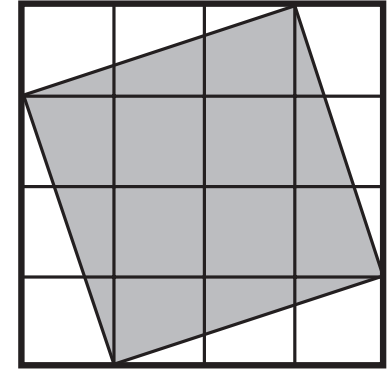

LP 106/8

a)

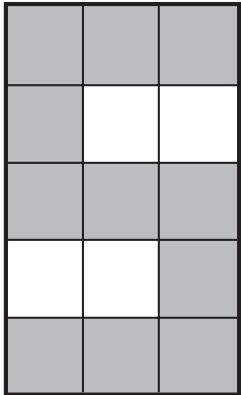

b)

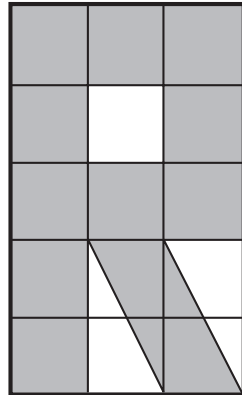

c)

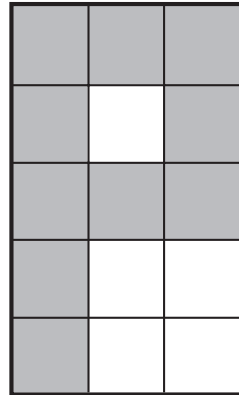

d)

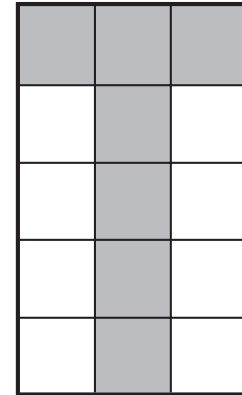

e)

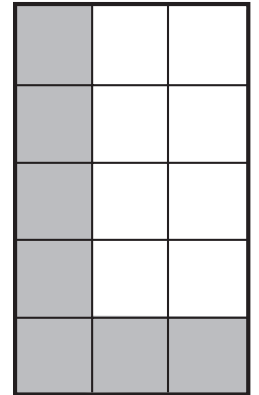

LP 108/2

a) $\frac{1}{3} + a = 1$

$a =$

b) $1 - b = \frac{5}{9}$

$b =$

c) $\frac{4}{3} + c = 2$

$c =$

d) $\frac{2}{5} + d = 1$

$d =$

e) $2 - e = \frac{7}{5}$

$e =$

f) $\frac{1}{6} + f = \frac{5}{6}$

$f =$

g) $\frac{3}{4} - g = \frac{1}{2}$

$g =$

h) $h - \frac{3}{10} = \frac{2}{5}$

$h =$

i) $i + \frac{4}{7} = \frac{3}{7}$

$i =$

a) $\frac{1}{2} + a = \frac{3}{2}$

$a =$

b) $\frac{3}{4} - b = \frac{1}{4}$

$b =$

c) $\frac{7}{8} + c = \frac{11}{8}$

$c =$

d) $d - \frac{3}{7} = \frac{2}{7}$

$d =$

e) $e + \frac{7}{9} = 1$

$e =$

f) $1 + f = \frac{6}{5}$

$f =$

g) $2 - g = \frac{7}{5}$

$g =$

h) $h - \frac{5}{6} = 1$

$h =$



1

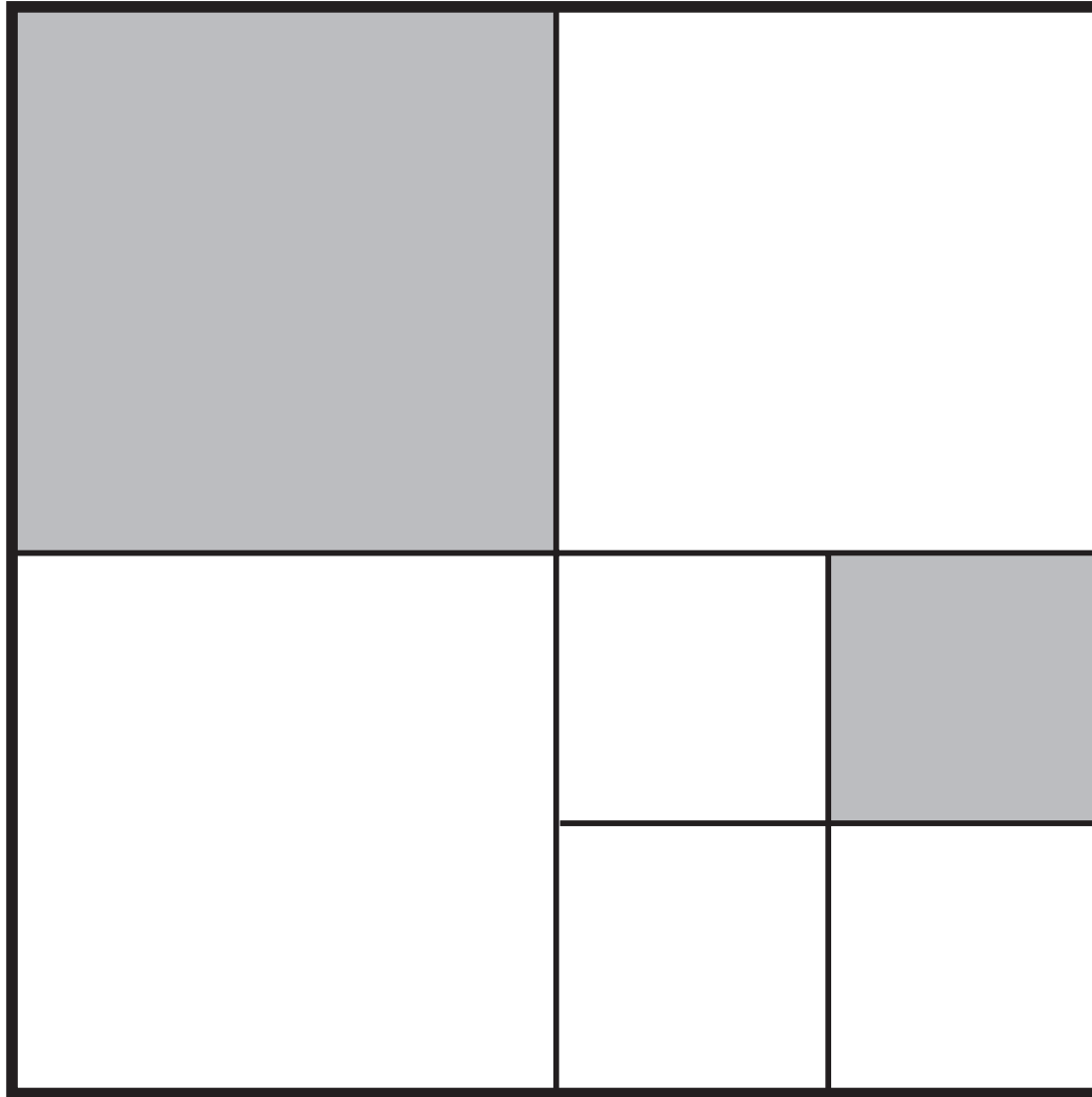

1

a) 1 week = days, 1 day = week, 4 days = week

b) 4 m = cm, 1 cm = m, 27 cm = m

c) 2 h = min, 1 min = hour, 40 min = hour

d) 17 litres = cl, 17 cl = litre, 320 ml = litre

a) $20 \text{ min} = \square \text{ hour,}$ $45 \text{ min} = \square \text{ hour,}$ $90 \text{ min} = \square \text{ hours}$

b) $\frac{1}{2} \text{ hour} = \square \text{ min,}$ $\frac{2}{5} \text{ hour} = \square \text{ min,}$ $\frac{61}{60} \text{ hour} = \square \text{ min}$

c) $70 \text{ cm} = \square \text{ m,}$ $110 \text{ cm} = \square \text{ m,}$ $3 \text{ cm} = \square \text{ m}$

d) $\frac{1}{5} \text{ m} = \square \text{ cm,}$ $\frac{9}{4} \text{ m} = \square \text{ cm,}$ $\frac{3}{50} \text{ m} = \square \text{ cm}$

e) $43 \text{ cl} = \square \text{ litre,}$ $350 \text{ g} = \square \text{ kg,}$ $11 \text{ m} = \square \text{ km}$

f) $\frac{5}{4} \text{ litres} = \square \text{ cl,}$ $\frac{42}{1000} \text{ kg} = \square \text{ g,}$ $\frac{32}{1000} \text{ km} = \square \text{ m}$